

Bullit – Jean-Marie Massaud – 2016



Bullit è un paesaggio da vivere. Il divano come spazio di comfort assoluto. Un sistema aperto a innumerevoli composizioni pensate come isole di relax. Decisamente importante la profondità della seduta. A rendere ogni configurazione ancora più eclettica e creativa, i cuscini mobili quadrati e rettangolari, imbottiti in piuma d'oca e rivestiti in pelle o tessuto, da moltiplicare a piacere.

CARATTERISTICHE TECNICHE

Struttura seduta, schienale e braccioli. In faggio e pioppo stagionato, con sponde in multistrato di betulla e tamponamenti in MDF.

Molleggio seduta. Cinghie elastiche.

Imbottitura. Schienale e braccioli: in poliuretano espanso e ovatta poliestere. Seduta: in piuma d'oca e fiocco poliestere con inserto stabilizzante in poliuretano espanso.

Cuscini disponibili.

- **Kit cuscini supporto schienale:** imbottiti in ovatta poliestere con inserto stabilizzante in poliuretano espanso. Rivestiti in pelle microforata nella parte anteriore.
- **Kit cuscini HB:** garantiscono un supporto lombare e poggiatesta. Imbottiti in ovatta poliestere con inserto stabilizzante in poliuretano espanso. I cuscini vengono fissati alla seduta tramite una struttura in acciaio. Un tubolare metallico mobile di colore nero semiopaco viene posizionato tra il cuscino schienale e lo schienale stesso.

Bullit + kit cuscini supporto schienale.

Rivestimento. Interamente in Pelle Frau® o nelle opzioni che abbinano più materiali. Il primo rivestimento viene applicato al divano mentre il secondo ai cuscini supporto schienale.

- | | |
|---------------------------------|---------------------------------|
| - Color System Frau® | - Fabric B / Color System Frau® |
| - Nest | - Fabric B / Nest |
| - Soul | - Fabric B / Soul |
| - Century | - C.O.M. / Color System Frau® |
| - Fabric A / Color System Frau® | - C.O.M. / Nest |
| - Fabric A / Nest | - C.O.M. / Soul |
| - Fabric A / Soul | |

Si consiglia di arricchire la composizione scelta con i cuscini schienale opzionali suggeriti nel disegno tecnico.

Per verificare i tessuti disponibili si prega di consultare la tabella dedicata "Schema abbinamento prodotti-tessuti".

Bullit + kit cuscini HB.

Rivestimento. Interamente in Pelle Frau®, in tessuto o nelle opzioni che abbinano pelle / tessuto su divano e cuscini HB (e viceversa).

- | | |
|----------------------|---------------------------------|
| - Color System Frau® | - C.O.M. |
| - Nest | - Fabric A / Color System Frau |
| - Soul | - Fabric A / Nest |
| - Century | - Fabric A / Soul |
| - Fabric A | - Fabric B / Color System Frau® |
| - Fabric B | - Fabric B / Nest |

Bullit is a landscape to be experienced, the sofa as a space of absolute comfort. A system open to countless compositions envisaged as islands of relaxation. The depth of the seat is a particularly important element. To make each configuration even more eclectic and creative, loose square and rectangular cushions, padded with goose-down and upholstered in leather or fabric, can be added at will.

TECHNICAL FEATURES

Seat, backrest and armrests structure. Made of seasoned solid beech wood and poplar, birch plywood sides and MDF infill panels.

Seat suspension. Elastic belts.

Padding. The backrest and armrests are padded with polyurethane foam and polyester wadding. The seat is padded with goose down and polyester staple with a polyurethane foam stabilizing insert.

Available cushions.

- **Backrest support cushions kit:** padded with polyester wadding with a polyurethane foam stabilising insert. Front side upholstered with micro-perforated leather.
- **HB cushions kit:** provide a lumbar and headrest support. They are padded with polyester wadding with a polyurethane foam stabilising insert. The cushions are secured to the seat thanks to a steel structure. A semi-matt black metal tubular is positioned between the backrest cushion and the backrest itself.

Bullit + backrest support cushions kit.

Upholstery. Fully upholstered in Pelle Frau® or in a combination with two materials. The first upholstery mentioned below is used for the sofa while the second one is used for the backrest support cushions.

- | | |
|---------------------------------|---------------------------------|
| - Color System Frau® | - Fabric B / Color System Frau® |
| - Nest | - Fabric B / Nest |
| - Soul | - Fabric B / Soul |
| - Century | - C.O.M. / Color System Frau® |
| - Fabric A / Color System Frau® | - C.O.M. / Nest |
| - Fabric A / Nest | - C.O.M. / Soul |
| - Fabric A / Soul | |

It is advisable to enrich the chosen composition with the optional back cushions suggested on the technical drawings.

To verify the available fabrics please consult the dedicated table "Combination models-fabrics pattern".

Bullit + HB cushions kit.

Upholstery. Fully upholstered in Pelle Frau®, fabric or in the combination of leather / fabric for the sofa and the HB cushions and vice versa.

- | | |
|----------------------|---------------------------------|
| - Color System Frau® | - C.O.M. |
| - Nest | - Fabric A / Color System Frau |
| - Soul | - Fabric A / Nest |
| - Century | - Fabric A / Soul |
| - Fabric A | - Fabric B / Color System Frau® |
| - Fabric B | - Fabric B / Nest |

- Fabric B / Soul
- C.O.M. / Color System Frau®
- C.O.M. / Nest

Per verificare i tessuti disponibili si prega di consultare la tabella dedicata "Schema abbinamento prodotti-tessuti".

Piedi. Disponibili in:

- Faggio laccato nero (11)
- Alluminio con finitura acciaio brunito (con sovrapprezzo).

È POSSIBILE REALIZZARE CONFIGURAZIONI SIMMETRICHE E ASIMMETRICHE UTILIZZANDO 3 BRACCIOLI DI DIVERSE ALTEZZE E UN MOBILE TERMINALE.

MOBILE TERMINALE

Disponibile in sostituzione ai braccioli dx o sx nelle versioni asimmetriche, componibili o angolari.

Struttura. In fibra di legno a media densità con impiallacciatura esterna in:

- Rovere tabacco opaco (56)
- Rovere piombo opaco (57)

Rivestimento interno in cuoio Saddle Extra. Due divisori verticali dalla forma arrotondata delimitando gli spazi della mensola a giorno. Sono realizzati in MDF e rivestiti in cuoio Saddle Extra.

Piedi. In acciaio spazzolato brunito.

ACCESSORI E COMPLEMENTI

Mobile Jolly. Presenta la stessa struttura e gli stessi appoggi previsti per il mobile terminale.

Piano sovrabracciolo. Realizzato in alluminio, rivestito in cuoio Saddle Extra e caratterizzato da una marcatura perimetrale realizzata a freddo manualmente. I bordi sono tagliati a vivo e rifiniti con tinta e cera protettiva.

Cuscini schienale opzionali suggeriti (solo in abbinamento al kit cuscini supporto schienale). Non inclusi nel prezzo. Imbottiti in piuma d'oca, sono disponibili nelle seguenti misure: 47X47, 60x60, 75x45, 90x45.

Rivestimento cuscini opzionali. In Pelle Frau® o in tessuto:

- Color System Frau® (SC)
- Nest
- Soul
- Century
- Fabric A
- Fabric B
- C.O.M.

Per verificare i tessuti disponibili si prega di consultare la tabella dedicata "Schema abbinamento prodotti-tessuti".

Sfoderabilità. Prevista per tutte le parti rivestibili in tessuto.

- Fabric B / Soul
- C.O.M. / Color System Frau®
- C.O.M. / Nest

To verify the available fabrics please consult the dedicated table "Combination models-fabrics pattern".

Feet. Available in:

- Black lacquered beech wood (11)
- Aluminium in a burnished steel finish (with surcharge).

IT IS POSSIBLE TO CREATE SYMMETRICAL OR ASYMMETRICAL COMPOSITIONS USING 3 ARMRESTS OF DIFFERENT HEIGHT AND AN END UNIT.

END UNIT

It can be used to replace left or right armrests in case of asymmetrical, modular or corner versions.

Structure. Made of MDF veneered, on the external surface, in:

- Tobacco oak with a matt finish (56)
- Lead oak with a matt finish (57)

Internal covering in Saddle Extra leather. Two rounded vertical partitions mark out the compartments of the open shelf. They are made of MDF and covered with Saddle Extra leather.

Feet. Brushed burnished steel.

ACCESSORIES AND FURNISHING UNITS

Freestanding modular unit. It features the same structure and feet provided for the end unit.

Armrest top cover. Made from aluminium, covered with Saddle Extra leather and embellished with handmade cold markings around the perimeter. The clean-cut edges are dyed and finished with protective wax.

Suggested optional back cushions (only in combination with the backrest support cushions kit). Not included in the price. Goose down filled, they are available in the following sizes: 47X47, 60x60, 75x45, 90x45.

Optional cushions upholstery. In Pelle Frau® leather or fabric:

- Color System Frau® (SC)
- Nest
- Soul
- Century
- Fabric A
- Fabric B
- C.O.M.

To verify the available fabrics please consult the dedicated table "Combination models-fabrics pattern".

Removability. Only for the parts upholstered in fabric.

BRACCIOLI E TERMINALI DISPONIBILI / AVAILABLE ARMRESTS

È POSSIBILE REALIZZARE CONFIGURAZIONI SIMMETRICHE E ASIMMETRICHE UTILIZZANDO 3 BRACCIOLI DI DIVERSE ALTEZZE E UN MOBILE TERMINALE

IT IS POSSIBLE TO CREATE SYMMETRICAL OR ASYMMETRICAL COMPOSITIONS USING 3 ARMRESTS OF DIFFERENT HEIGHT AND AN END UNIT.

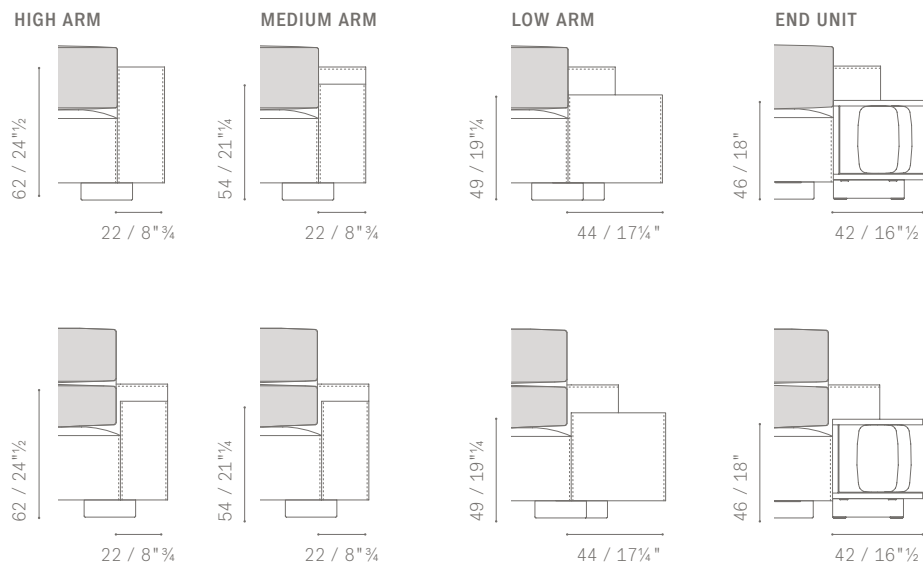

PIEDI OPZIONALI / OPTIONAL FEET

PIEDI IN ALLUMINIO / ALUMINIUM FEET

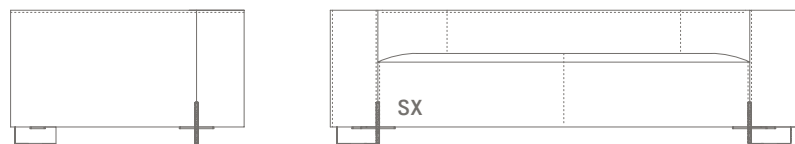

DIVANI SIMMETRICI E ASIMMETRICI / SYMMETRICAL AND ASYMMETRICAL SOFAS

DIVANI 2 POSTI
 2 SEATER SOFAS
 DIVANI 2 POSTI LARGE
 LARGE 2-SEATER SOFAS
 DIVANI 3 POSTI
 3 SEATER SOFAS
 POUF
 OTTOMAN

5587211

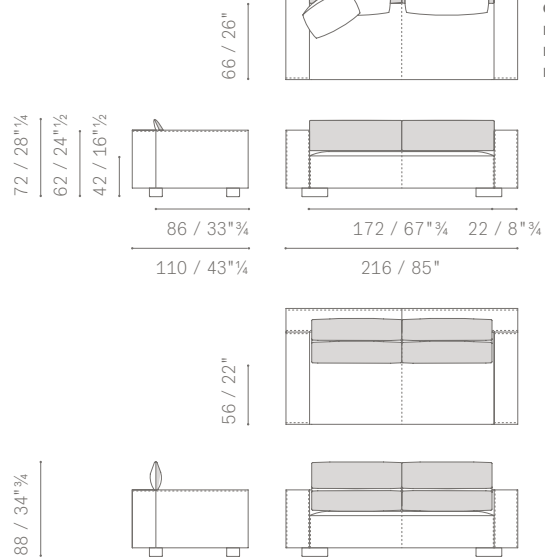

Suggested extra cushions
 n. 1 60x60
 n. 1 75x45
 n. 1 47x47

5587216

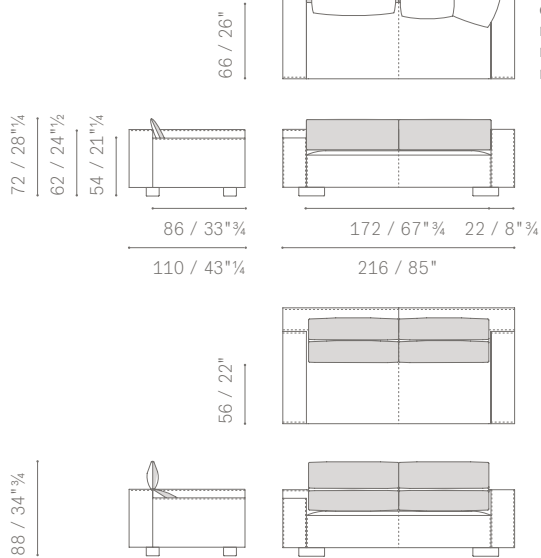

Suggested extra cushions
 n. 1 60x60
 n. 1 75x45
 n. 1 47x47

5587216

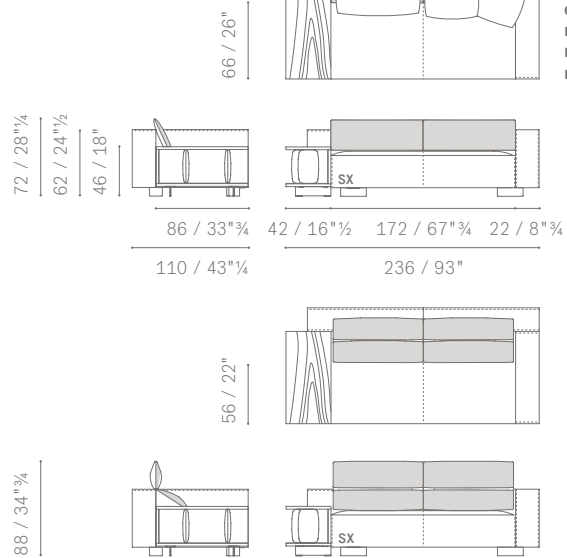

Suggested extra cushions
 n. 1 60x60
 n. 1 75x45
 n. 1 47x47

5587281

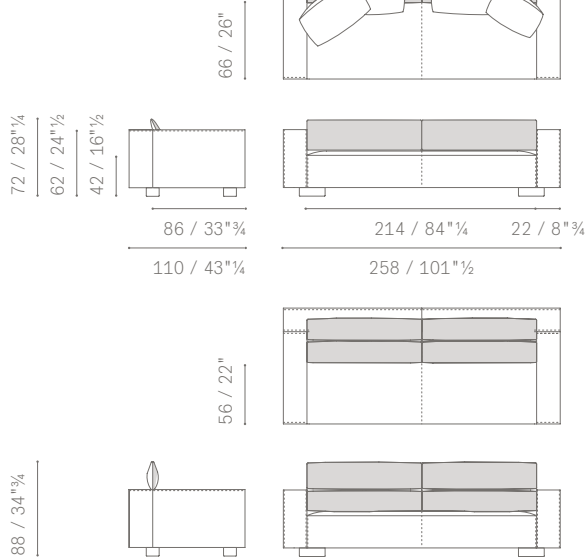

Suggested extra cushions
 n. 2 60x60
 n. 1 90x45
 n. 1 47x47

5587286

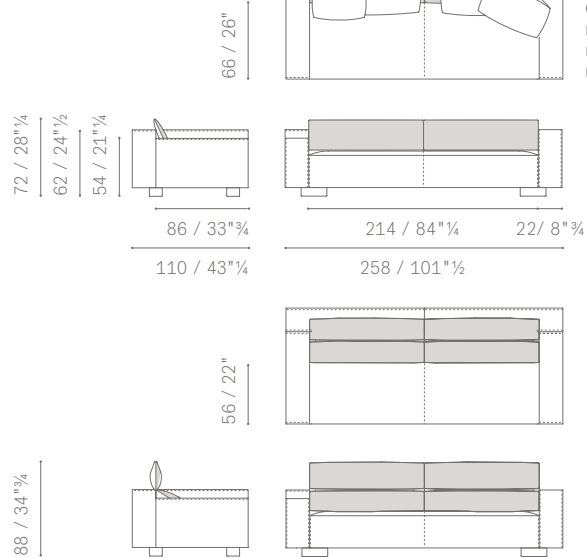

Suggested extra cushions
 n. 2 60x60
 n. 1 90x45
 n. 1 47x47

DIVANI SIMMETRICI E ASIMMETRICI / SYMMETRICAL AND ASYMMETRICAL SOFAS

5587286

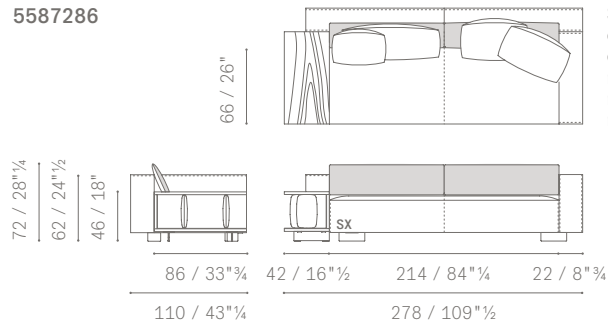

Suggested extra cushions
n. 2 60×60
n. 1 90×45
n. 1 47×47

5587311

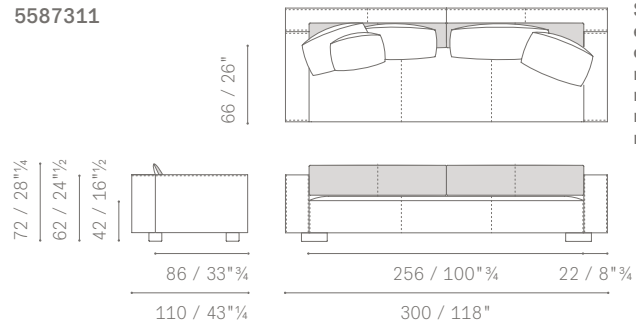

Suggested extra cushions
n. 2 60×60
n. 1 90×45
n. 1 75×45
n. 1 47×47

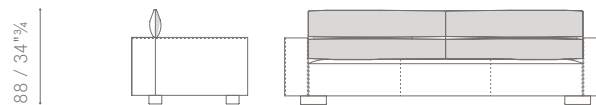
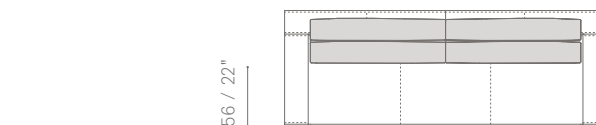
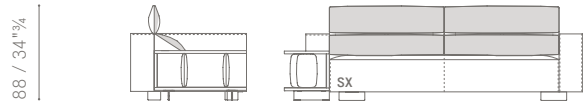
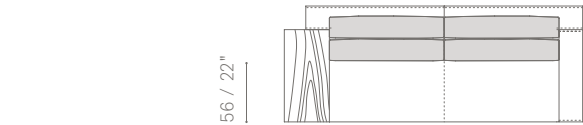

5587316

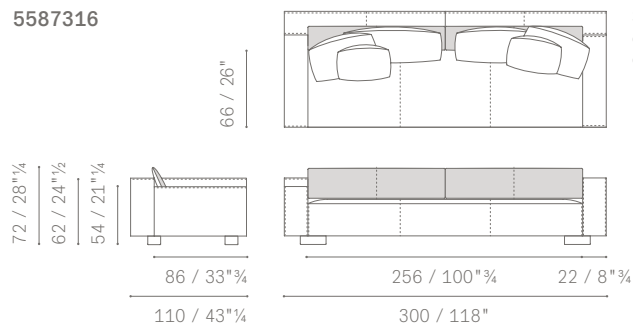

Suggested extra cushions
n. 2 60×60
n. 1 90×45
n. 1 75×45
n. 1 47×47

5587316

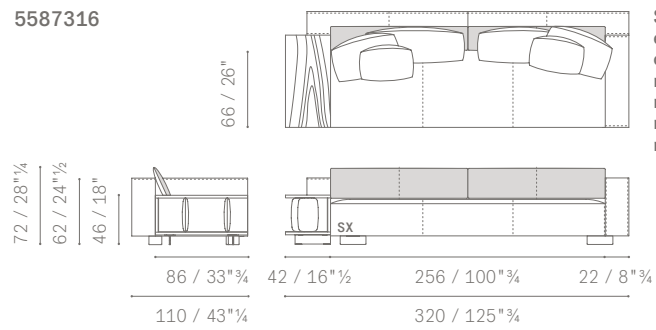

Suggested extra cushions
n. 2 60×60
n. 1 90×45
n. 1 75×45
n. 1 47×47

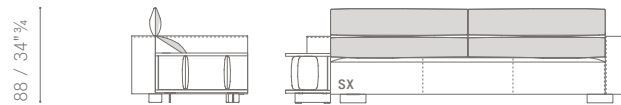
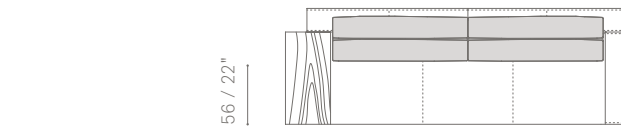
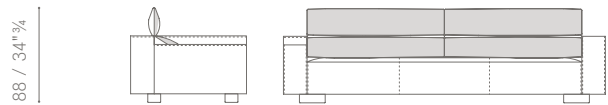
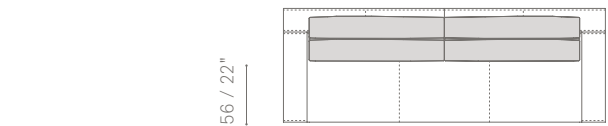

5587511

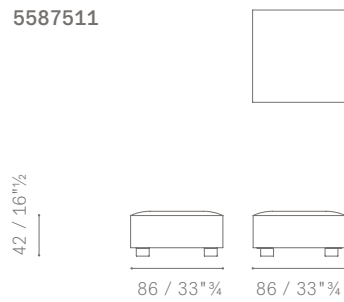

5587512

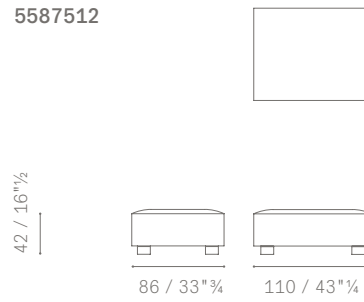

MODULI CON PANCA / MODULES WITH BENCH

POLTRONA CON PANCA
ARMCHAIR WITH BENCH

5587121

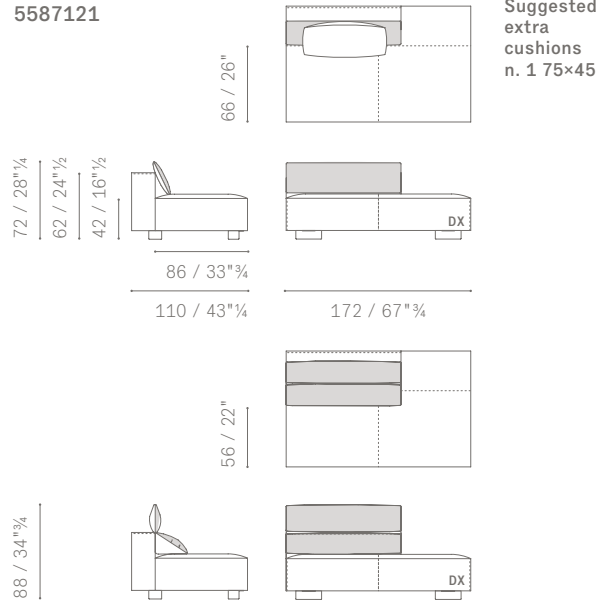

MODULI COMPONIBILI E TERMINALI / SECTIONAL MODULES AND SOFAS

DIVANI 2 POSTI
2-SEATER SOFAS
DIVANI 2 P. LARGE
LARGE 2-SEATER SOFAS
DIVANI 3 POSTI
3-SEATER SOFAS
CHAISE LONGUE
CHAISE LONGUE
PENISOLA
FREESTANDING MODULE

5587221

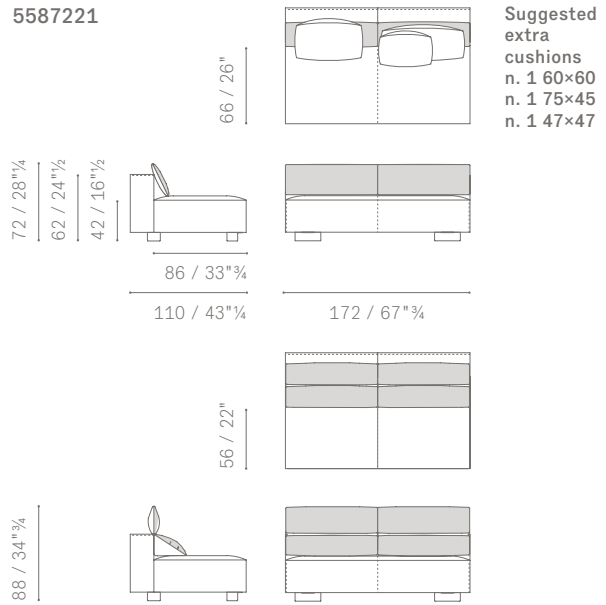

5587221

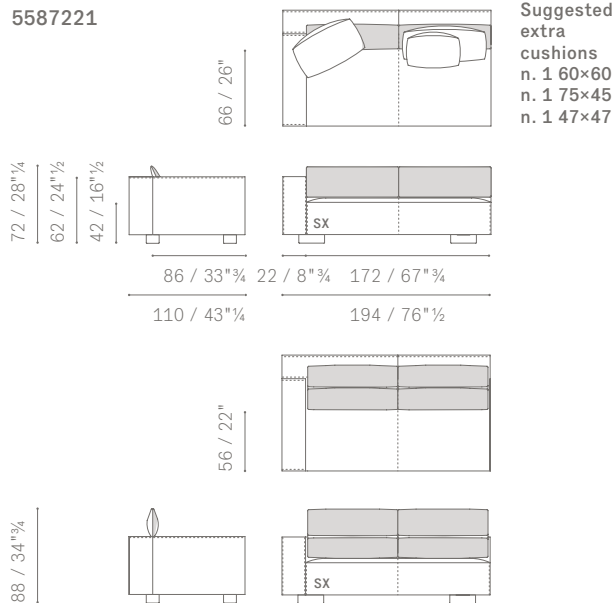

5587226

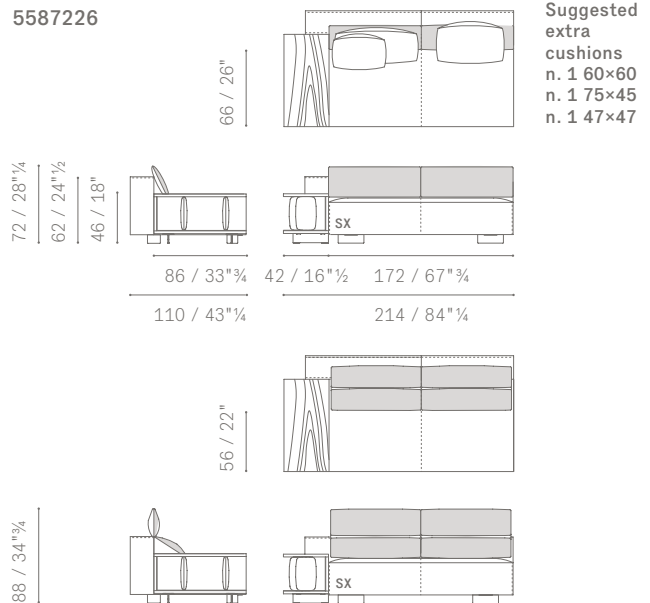

MODULI COMPONENTI E TERMINALI / SECTIONAL MODULES AND SOFAS

5587291

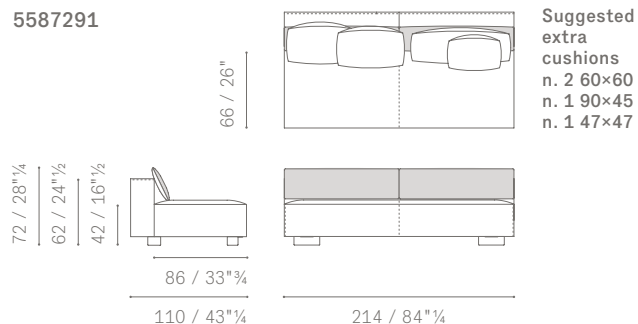

5587291

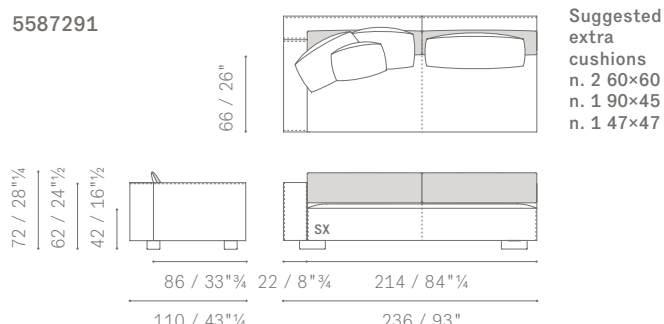

5587296

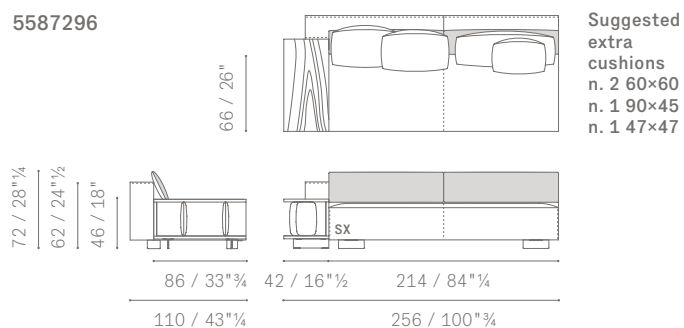

5587321

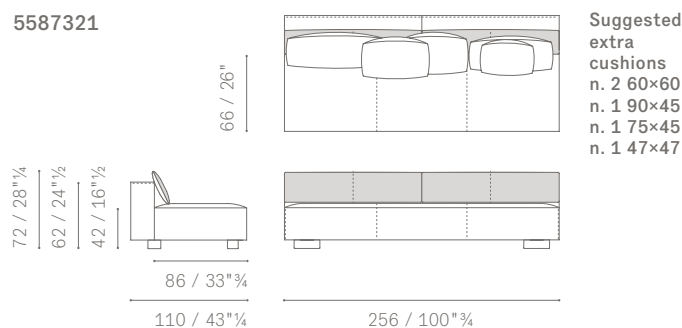

5587321

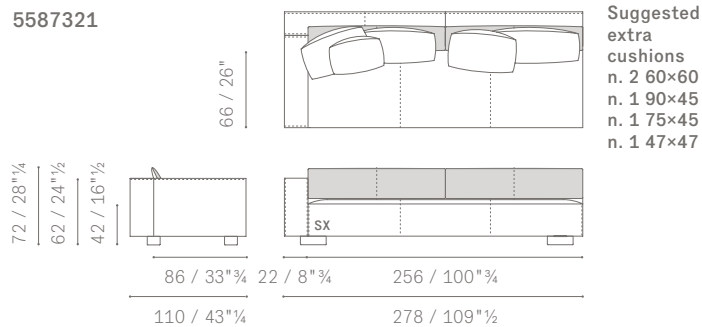

5587326

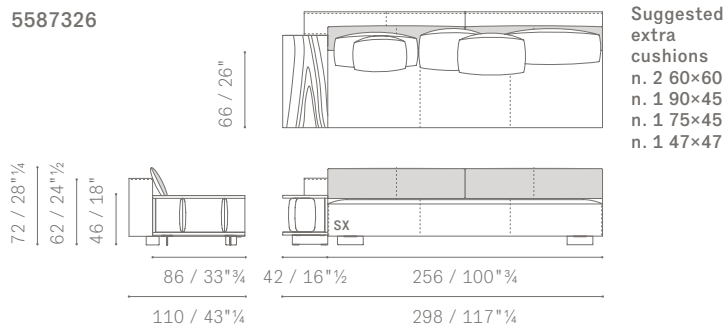

88 / 34"³/₄

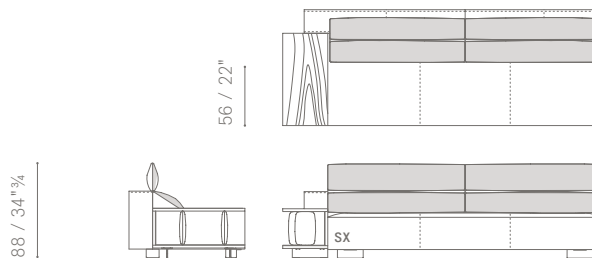
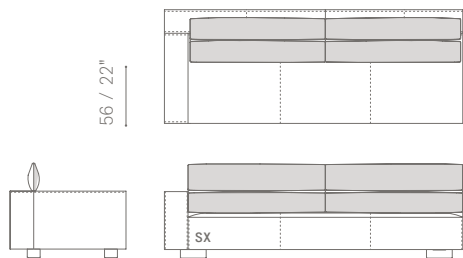
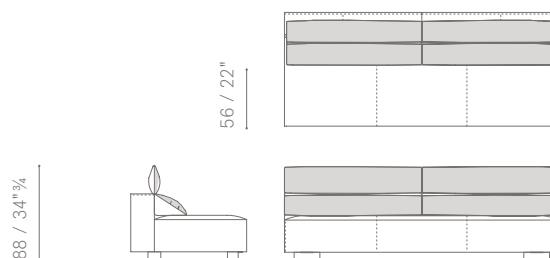
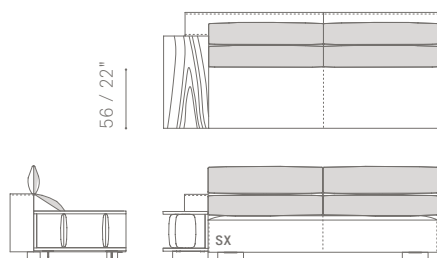
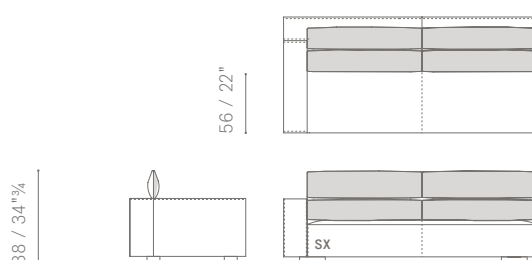
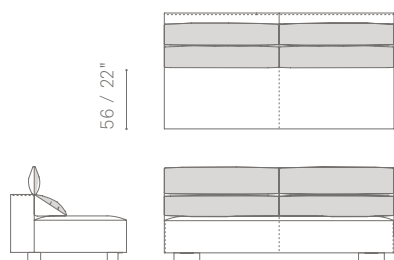

MODULI COMPONENTI E TERMINALI / SECTIONAL MODULES AND SOFAS

5587146

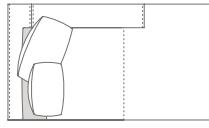

Suggested extra cushions
n. 1 60×60
n. 1 47×47

72 / 28"¹/₄
62 / 24"¹/₂
42 / 16"¹/₂

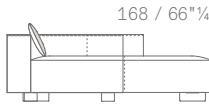

168 / 66"¹/₄

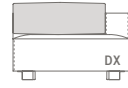

153 / 60"¹/₄ 88 / 34"³/₄ 22 / 8"³/₄

190 / 74"³/₄ 110 / 43"³/₄

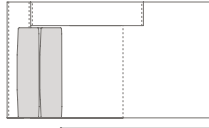

137 / 54"

88 / 34"³/₄

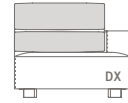
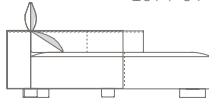

5587126

Suggested extra cushions
n. 1 60×60
n. 1 75×45
n. 1 47×47

72 / 28"¹/₄
62 / 24"¹/₂
42 / 16"¹/₂

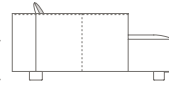

128 / 50"³/₄ 22 / 8"³/₄ 128 / 50"³/₄

150 / 59" 150 / 59"

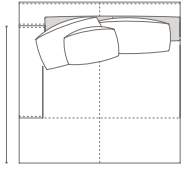

108 / 42"¹/₂

88 / 34"³/₄

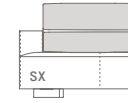
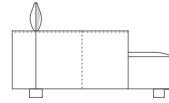

98 / 38"¹/₂

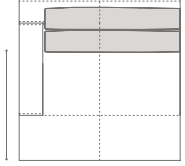

MODULI E DIVANI ANGOLARI / CORNER MODULES AND SOFAS

DIVANI 2 POSTI ANGOLARE
2-SEATER CORNER SOFAS
DIVANI 2 P. LARGE ANGOLARI
LARGE 2-SEATER CORNER SOFAS
DIVANI 3 POSTI ANGOLARE
3-SEATER CORNER SOFAS

5587201

66 / 26"

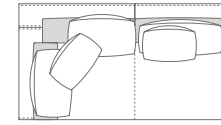

Suggested extra cushions
n. 2 60×60
n. 1 75×45
n. 2 47×47

72 / 28"¹/₄
62 / 24"¹/₂
42 / 16"¹/₂

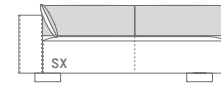
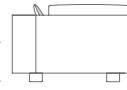

86 / 33"³/₄ 22 / 8"³/₄ 172 / 67"³/₄

110 / 43"³/₄ 194 / 76"¹/₂

56 / 22"

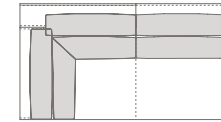

88 / 34"³/₄



5587201

66 / 26"

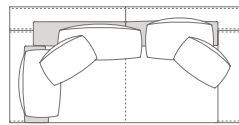

Suggested extra cushions
n. 2 60×60
n. 1 75×45
n. 2 47×47

72 / 28"¹/₄
62 / 24"¹/₂
42 / 16"¹/₂

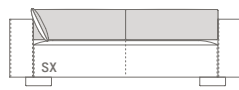
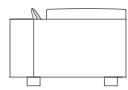

86 / 33"³/₄ 22 / 8"³/₄ 172 / 67"³/₄

110 / 43"³/₄ 216 / 85"¹/₂

56 / 22"

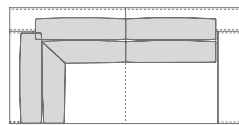

88 / 34"³/₄

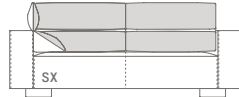
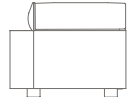

5587206

66 / 26"

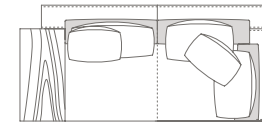

Suggested extra cushions
n. 2 60×60
n. 1 75×45
n. 2 47×47

72 / 28"¹/₄
62 / 24"¹/₂
46 / 18"

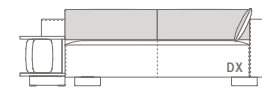
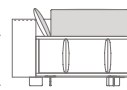

86 / 33"³/₄ 42 / 16"¹/₂ 172 / 67"³/₄ 22 / 8"³/₄

110 / 43"³/₄ 236 / 93"

56 / 22"

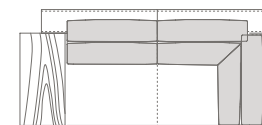

88 / 34"³/₄

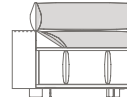

MODULI E DIVANI ANGOLARI / CORNER MODULES AND SOFAS

5587271

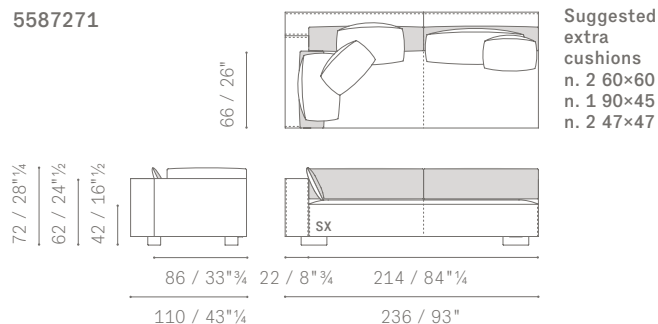

5587271

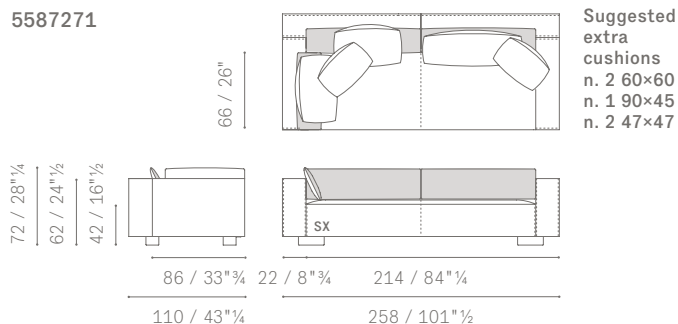

5587276

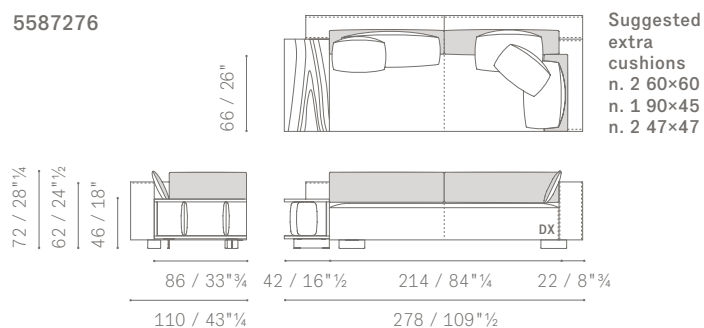

5587301

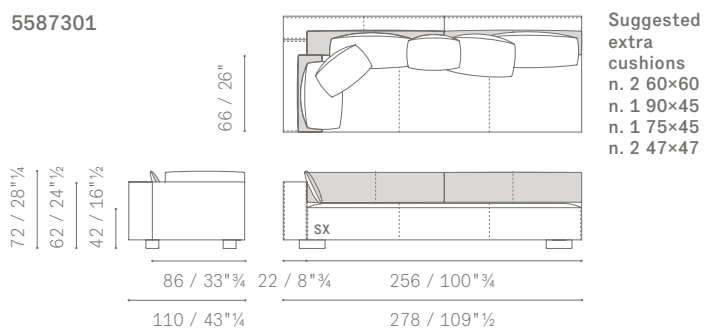

5587301

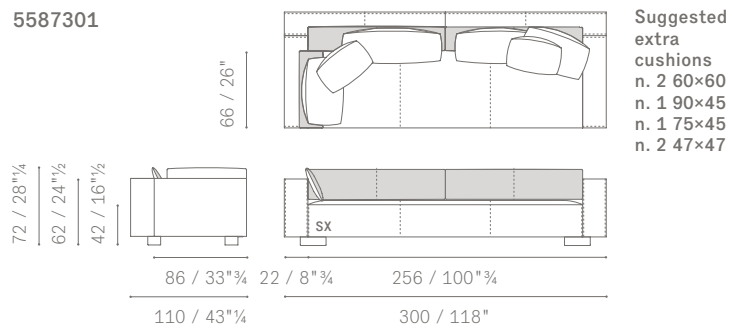

5587306

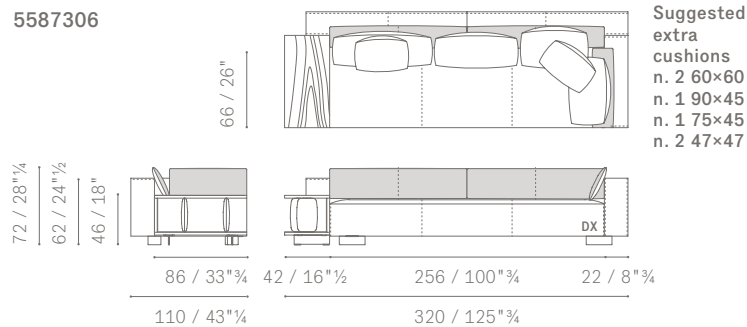

CUSCINI / CUSHIONS

CUSCINI SCHIENALE OPZIONALI SUGGERITI
SUGGESTED OPTIONAL BACK CUSHIONS

5587561

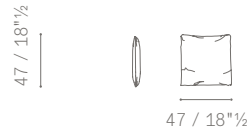

5587563

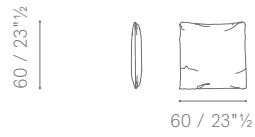

5587566



5587567



CUSCINO DI SUPPORTO SCHIENALE
BACKSEAT SUPPORT CUSHION

5587591



ACCESSORI E COMPLEMENTI / ACCESSORIES AND FURNISHING UNITS

5587407



5587780

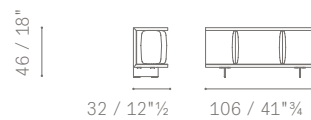

ESEMPIO DI COMPOSIZIONE 1 / LAYOUT EXAMPLE NO. 1

- 5587276** Divano 2 posti large angolare DX con piano terminale
Corner large 2 seater sofa (DX) with end top
- 5587221** Divano 2 posti DX
2 seater sofa DX

Cuscini schienale
Back cushion

5587561 n. 3 47×47 cm
5587563 n. 3 60×60 cm
5587566 n. 1 75×45 cm
5587567 n. 1 90×45 cm

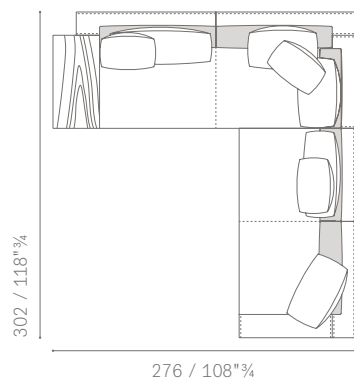

ESEMPIO DI COMPOSIZIONE 2 / LAYOUT EXAMPLE NO. 2

- 5587301** Divano 3 posti angolare DX
Corner 3 seater sofa DX
- 5587121** Poltrona senza braccioli con panca DX
Sectional armless chair w/bench DX

Cuscini schienale
Back cushion

5587561 n. 2 47×47 cm
5587563 n. 2 60×60 cm
5587566 n. 1 75×45 cm
5587567 n. 1 90×45 cm

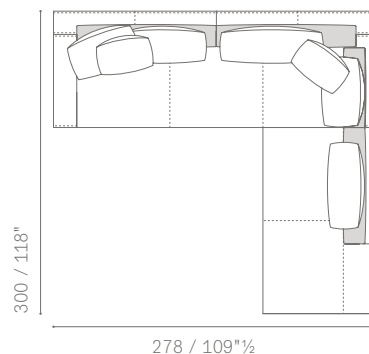

ESEMPIO DI COMPOSIZIONE 3 / LAYOUT EXAMPLE NO. 3

- 5587221** Divano 2 posti SX
2 seater sofa SX
- 5587146** Chaise longue DX
Chaise longue DX

Cuscini schienale
Back cushion

5587561 n. 2 47×47 cm
5587563 n. 2 60×60 cm
5587566 n. 1 75×45 cm

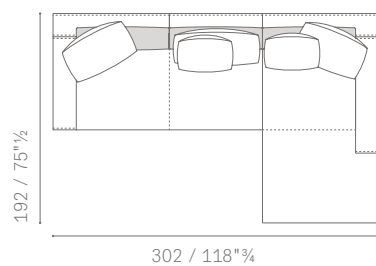

ESEMPIO DI COMPOSIZIONE 4 / LAYOUT EXAMPLE NO. 4

- 5587306** Divano 3 posti angolare DX con piano terminale
Corner 3 seater sofa (DX) with end top
- 5587221** Divano 2 posti DX
2 seater sofa DX

Cuscini schienale
Back cushion

5587561 n. 3 47×47 cm
5587563 n. 3 60×60 cm
5587566 n. 2 75×45 cm
5587567 n. 1 90×45 cm

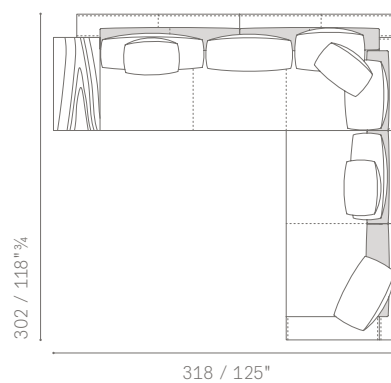

ESEMPIO DI COMPOSIZIONE 5 / LAYOUT EXAMPLE NO. 5

- 5587121** Poltrona senza braccioli con panca SX /
Armless armchair w/bench SX
- 5587271** Divano 2 posti large angolare DX senza bracciolo /
Corner large 2 seater sofa (DX) w/out arm
- 5587291** Divano 2 posti large DX /
Large 2 seater sofa DX

- Cuscini schienale
Back cushion
- 5587561** n. 3 47×47 cm
 - 5587563** n. 4 60×60 cm
 - 5587566** n. 1 75×45 cm
 - 5587567** n. 2 90×45 cm

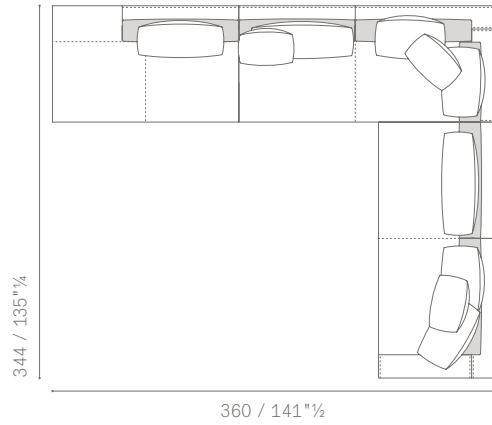

ESEMPIO DI COMPOSIZIONE 6 / LAYOUT EXAMPLE NO. 6

- 5587296** Divano 2 posti large senza braccioli con piano SX /
Large 2 seater armless sofa with end top SX
- 5587126** Penisola DX
Freestanding module DX

- Cuscini schienale
Back cushion
- 5587561** n. 2 47×47 cm
 - 5587563** n. 3 60×60 cm
 - 5587566** n. 1 75×45 cm

