

ARENA DIVANO

E. Gallina

2014



ARENA DIVANO

E. Gallina

2014

Divano con struttura in massello di frassino e rivestimento nei tessuti della collezione. Dotato di due cuscini per lo schienale e un cuscino unico per la seduta. Possibilità di combinare diversi tessuti per la struttura imbottita della base e dello schienale e i cuscini di seduta e schienale. Cuscini sfoderabili.

Sofa with frame in solid ash and cover in the fabrics of the collection. Equipped with two back cushions and one single seat cushion. It is possible to combine different fabrics for the upholstered base and back and for the seat and back cushions. Removable cover for cushions only.

Sofa mit Gestell aus massiver Esche und Bezug in den Stoffen der Kollektion. Mit zwei Rückkissen und einzelnen Sitzkissen. Stoffkombination zwischen gepolsterten Gestell und Rück-, Sitz und Rück-Kissen sind möglich. Abnehmbarer Bezug nur für Kissen.

Canapé avec structure en frêne massif et revêtement dans les tissus de la collection. Avec deux coussins pour le dossier et un seul coussin pour l'assise. Possibilité de combiner tissus différents entre la structure tapissée de la base et du dossier et les coussins de l'assise et du dossier. Revêtement déhoussable pour les coussins seulement.

Sofá con estructura en fresno macizo y revestimiento en las telas de la colección con dos cojines para el respaldo y un cojín para el asiento. Es posible combinar diferentes telas entre estructura revestida de la base y del respaldo y cojines de asiento y respaldo. Cojines desenfundables.

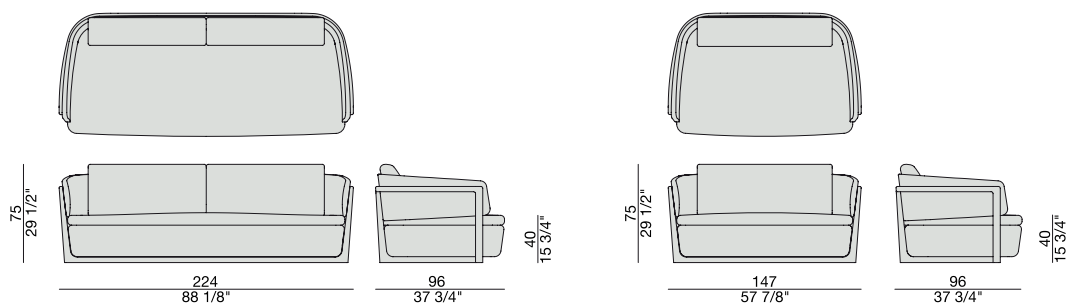

ESSENZE | *Essences*



Frassino Naturale
Natural Ash



Frassino
Ash
tinto/stained moka



Frassino
Ash
tinto noce canaletta
canaletta walnut stained



Frassino
Ash
tinto/stained wengé

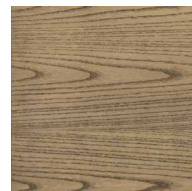

Frassino
Ash
tinto/stained canapa

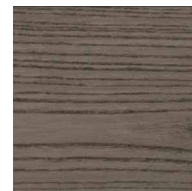

Frassino
Ash
tinto/stained caffè

LACCATO OPACO PORO APERTO | *Matt lacquered open pore*

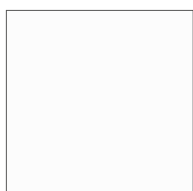

Bianco
White
(RAL 9016)

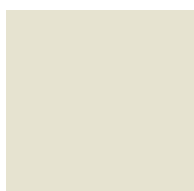

Avorio
Ivory
(RAL 1013)

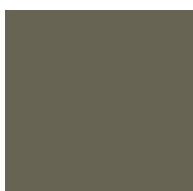

Argilla
Mud
(RAL 7006)



Piombo
Lead
(NCS S5005G20Y)



Cioccolato
Chocolate
(RAL 8019)

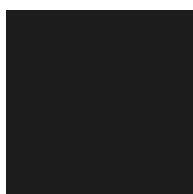

Nero
Black
(RAL 9005)



Granata
Garnet red
(NCS S4050Y90R)



Pistacchio
Pistachio green
(PANTONE 5825)



Avio
Aviation blue
(PANTONE 5415)

PELLE | *Leather*

Categoria LUX

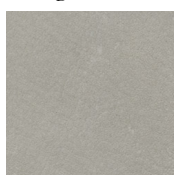

Nabuk

Categoria PLUS



Pelle PLUS

Categoria PELLE



Pelle

Categoria EXTRA

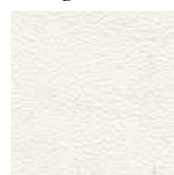

Pelle EXTRA

RIVESTIMENTO | *Cover*

Categoria A



Hallingdal 65

Categoria B



Rabat



Milord

Categoria C



Fashion



Moran



Thalys

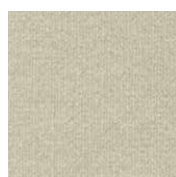

Velvet



Wool



Flax



Armam



Ikat

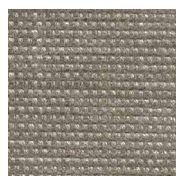

Loom

Categoria D



Astra

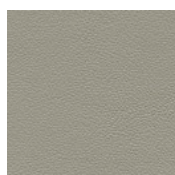

Ecopelle



Range



Tress

Categoria E

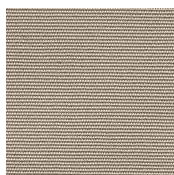

Cotone



Dorian



In Bianco/Calico

Categoria COM

Disponibile con tessuto fornito dal cliente.

Available with fabric supplied by the customer.

Verfügbar mit Kundenstoff.

Disponibile avec tissu du client.

Disponibile con tela suministrada por el cliente.