

## Square 16 2004/2016



### Divano a due o più posti e divano componibile

#### Materiali:

STRUTTURA: acciaio e legno con cinghie elastiche.

PIEDINI: acciaio verniciato a polvere color canna di fucile con sottopiede regolabile in materiale termoplastico.

IMBOTTITURA: poliuretano espanso a quote differenziate e ovatta di poliestere rivestito con vellutino di poliestere. Per le versioni FR (Fire Resistant) a richiesta, i materiali dell'imbottitura sono come da normative.

CUSCINO SCHIENALE: piuma d'oca mista a fibra di poliestere rivestito con tela di cotone.

CUSCINO DI SEDUTA E BRACCIOLO: piuma d'oca con supporto in poliuretano espanso rivestito con tela di cotone.

RIVESTIMENTO ESTERNO: rivestimento tecnicamente sfoderabile in tessuto o fisso in pelle o velluto.

+info:

<http://www.depadova.com/materials.pdf>

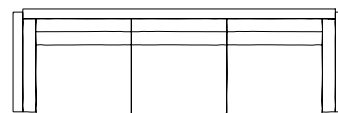
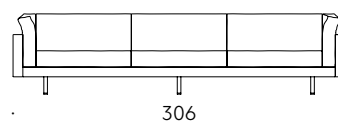
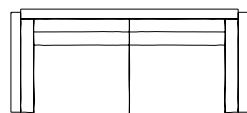
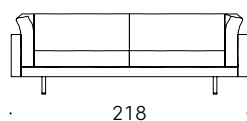
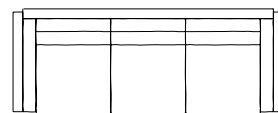
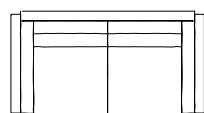
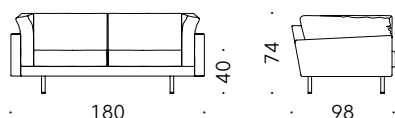

Esempi di composizione

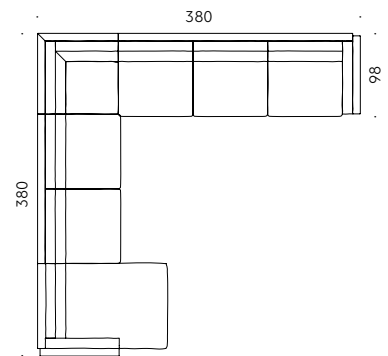
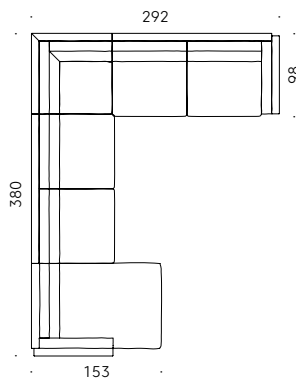
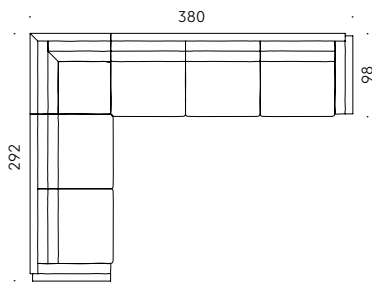
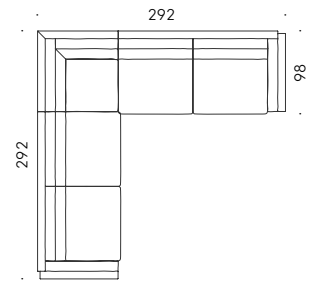
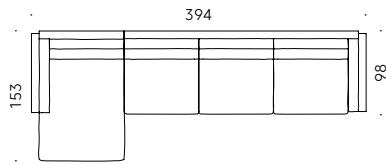
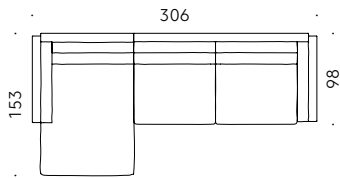

## Square 16 2004/2016



### Two or more-seater sofa and modular sofa

**Materials:**

FRAME: steel and wood with elastic straps.  
 FEET: powder coated steel, gunbarrel grey coloured, with adjustable thermoplastic glide feet.  
 PADDING: variable-density foamed polyurethane and polyester wadding covered with polyester velveteen. For FR (Fire Resistant) versions: padding materials follow current regulations.  
 BACKREST CUSHION: goose down mixed with polyester fibres, covered in cotton cloth.  
 SEAT AND ARMREST CUSHION: goose down with support in foamed polyurethane, covered with cotton cloth.  
 EXTERNAL COVER: totally removable cover in fabric or non-removable in leather or velvet.

+info:  
<http://www.depadova.com/materials.pdf>

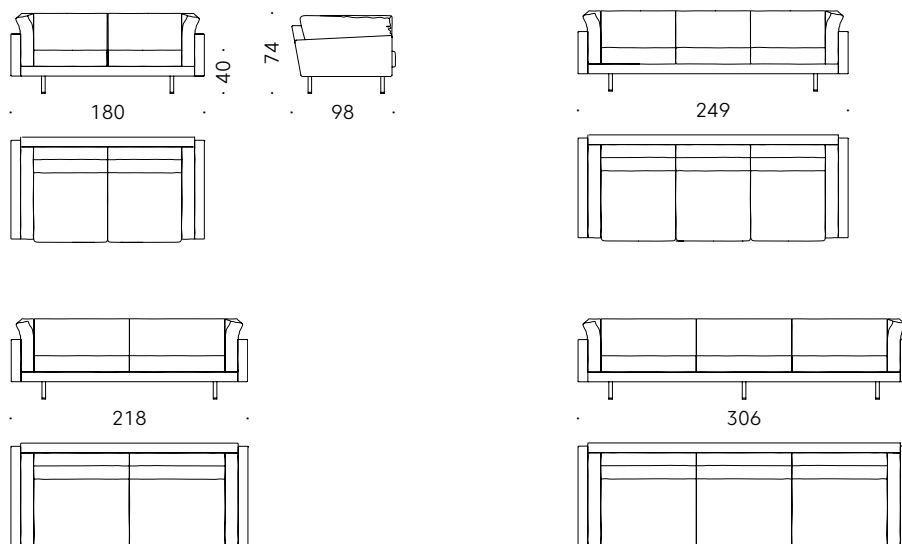

Composition Examples

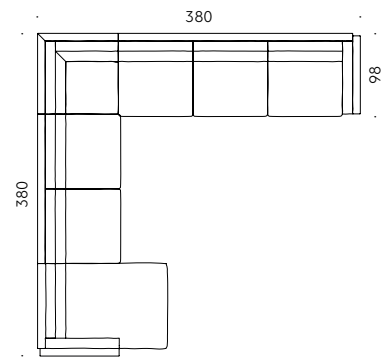
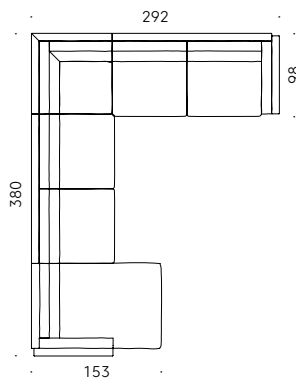
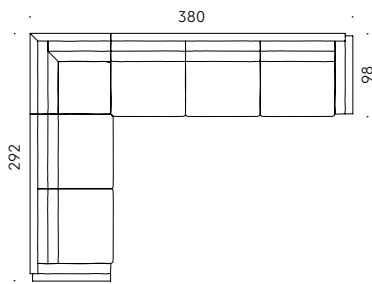
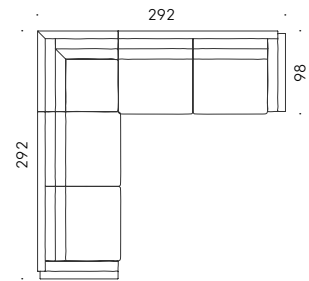
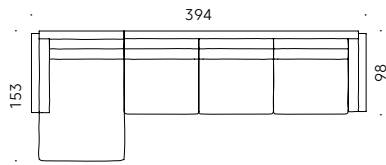
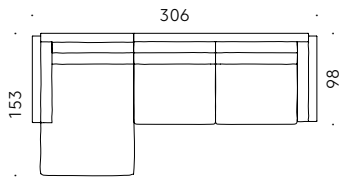

## Square 16 2004/2016



### Canapé à deux places ou plus et canapé modulable

#### Matériaux:

STRUCTURE: acier et bois avec sangles élastiques.

PIEDS: acier peint à poudre couleur canon de fusil avec patin réglables en thermoplastique.

REMOBOURRAGE: mousse de polyuréthane à densité variable et ouate de polyester, revêtu avec velours de polyester. Pour les versions FR (Fire Resistant) sur demande, les matériaux du rembourrage sont conformes aux réglementations.

COUSSIN DE DOSSIER: plume d'oie mixte avec fibre de polyester avec toile de coton.

COUSSIN D'ASSISE ET ACCOUDOIR: plume d'oie avec support en mousse de polyuréthane revêtu avec toile de coton.

REVÊTEMENT EXTERNE: revêtement techniquement déhoussable en tissu ou fixe en cuir ou velours.

+info:

<http://www.depadova.com/materials.pdf>

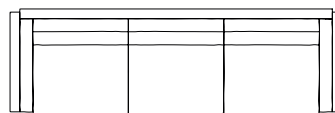
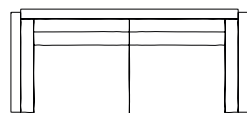
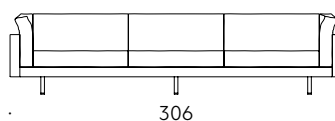
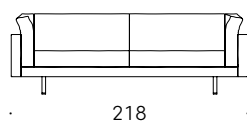
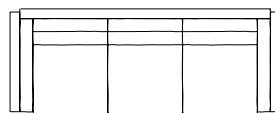
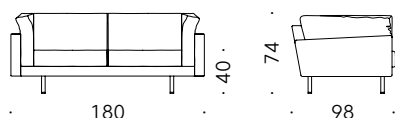

Exemples de composition

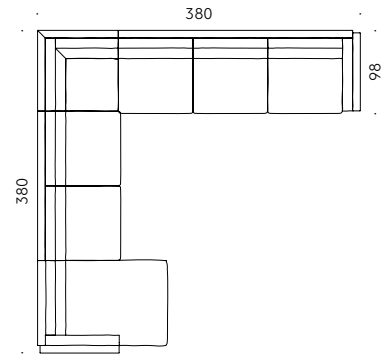
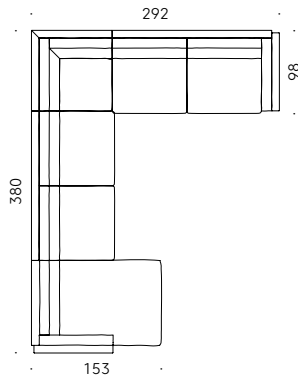
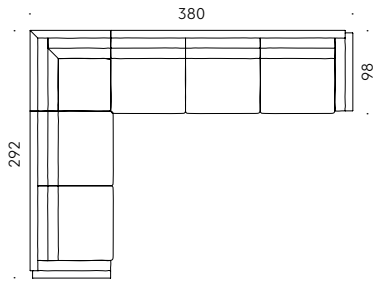
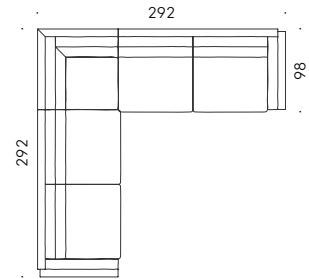
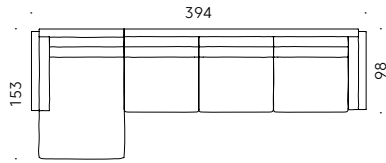
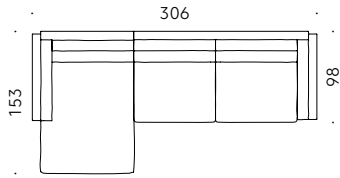

## Square 16 2004/2016



### Zwei- oder mehrsitziges Sofa und modulares Sofa

#### Materialien:

GESTELL: Stahl und Holz mit elastischen Gurten.

FÜßE: Stahl mit Pulverlackierung, metallgrau. Verstellbare Thermoplast-Gleitfüße.

POLSTERUNG: Polyurethanschaum unterschiedlicher Dichte und Polyesterwatte mit Überzug aus Polyestersamt. Bei den FR-Versionen (Fire Resistant) entsprechen die Polstermaterialien den geltenden Bestimmungen.

RÜCKENLEHNENKISSEN: Gänsedaunen gemischt mit Polyesterfaser und Überzug aus Baumwollgewebe.

SITZKISSEN UND ARMLEHNE: Gänsedaunen mit Kern aus Polyurethanschaum und Überzug aus Baumwollgewebe.

AUBENBEZUG: abnehmbarer Stoffbezug oder fester Leder-oder Samtbezug.

+info:

<http://www.depadova.com/materials.pdf>

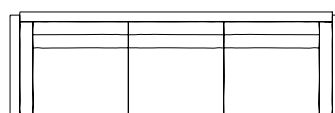
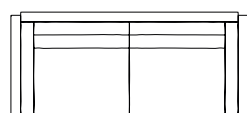
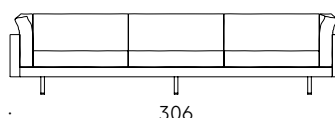
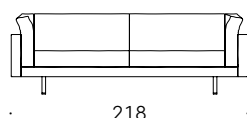
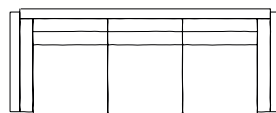
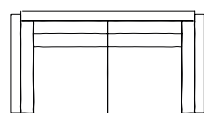
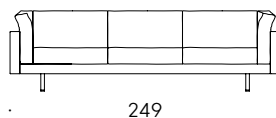
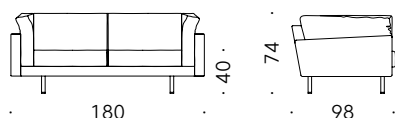

Kompositionsbeispiele

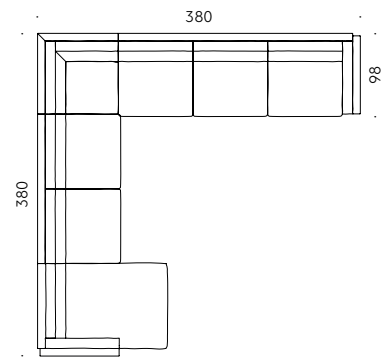
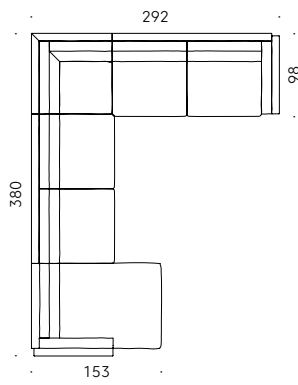
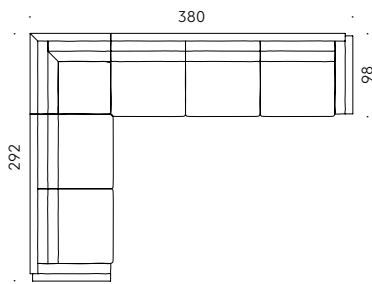
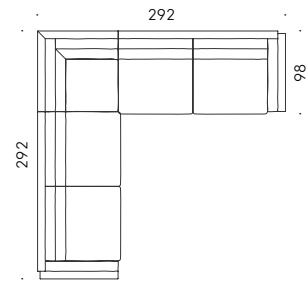
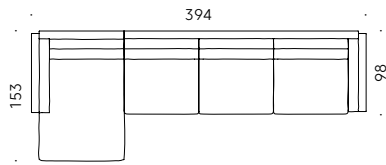
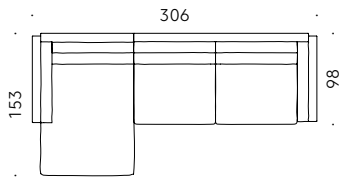



## Square 16 2004/2016



### Sofá de dos o más plazas y sofá modular

#### Materiales:

ESTRUCTURA: acero y madera con cinchas elásticas.

PIES: acero pintado en polvo color gris plomo con boaj-pies ajustables de material termoplástico.

RELLENO: espuma de poliuretano de densidad diferente y gata de poliéster revestida con terciopelo de poliéster. Para las versiones FR (Fire Resistant) bajo pedido, los materiales del relleno cumplen con las normativas.

COJÍN RESPALDO: plumas de oca mixtas con fibra de poliéster revestido con tela de algodón.

COJÍN DE ASIENTO Y BRAZO: plumas de oca con soporte de espuma de poliuretano revestida con tela de algodón.

TAPIZADO EXTERIOR: tapizado técnicamente desenfundable de tejido o fijo de piel o terciopelo.

+info:

<http://www.depadova.com/materials.pdf>

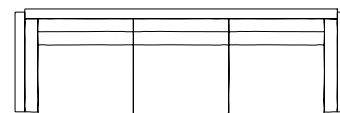
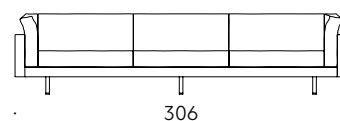
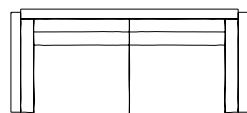
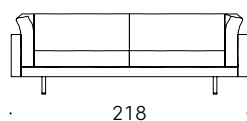
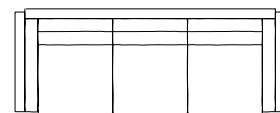
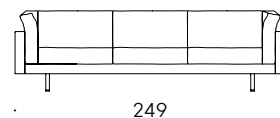
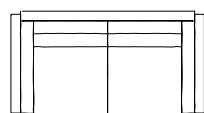
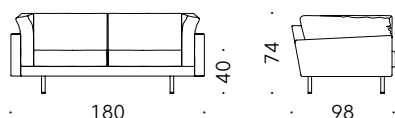

Ejemplos de composición

