













Althon high

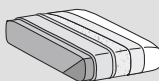

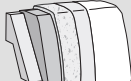
	Seat - Assise	Backrests - Dossiers	Structure - Structure	
Upholstering Revetement (12)	Removable <i>Déhoussable</i>	 		
	Not removable <i>Non déhoussable</i>	—		
Padding Rembourrages (5-6-7-8-9-10-11)	   D.35/50kg/m ³	 +  D.25-30kg/m ³	 Polyurethane foam	 ETHICALLY SOFT MADE optional

TECHNICAL INFORMATION

Structure: 1-3

Supporting structure in various thickness spruce and beech. Sides and partition in class E1 particleboard panels, details in hardboard panels or cellulose panels.

Springing: 1-4

The back is made of hard or cellulose wooden fibre panels. The seat is supported by propylene and latex elastic belts.

Note:

ALTHON arm available in recycled bonded leather in natural (CR01), brown (CR02), taupe (CR03), grey (CR05), dark brown (CR08), hemp (CR10); the stitching on the arm is in the same shade as the leather, in the rounded part there are closing plugs in stainless steel finish (2).

In the fabric version use only Miami fabric for the insert (14). In the leather version the insert it is not available.

INFORMATIONS TECHNIQUES

Structure: 1-3

Parties de soutien en bois de sapin et étre de différentes épaisseurs. Cotes latéral en panneaux de particules de bois en classe E1, particuliers en panneaux de fibre de bois dure ou cellulose.

Suspension: 1-4

Dossier en panneaux de fibre de bois dure ou cellulose. Assise avec sangles élastiques de fibre propylénique et latex.

Note:

Accoudoirs ALTHON disponibles en cuir régénéré dans les couleurs naturel (CR01), marron (CR02), tourterelle (CR03), gris (CR05), marron foncé (CR08) et chanvre (CR10); la couture sur l'accoudoir est toujours en teinte avec le cuir, sur la partie arrondie sont présentes des bouchons de fermeture en métal finition inox (2).

Dans la version en tissu pour l'insert (14) utiliser uniquement le tissu Miami. Dans la version en cuir l'insert ce n'est pas disponible.

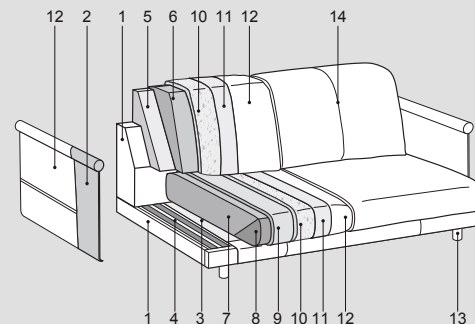
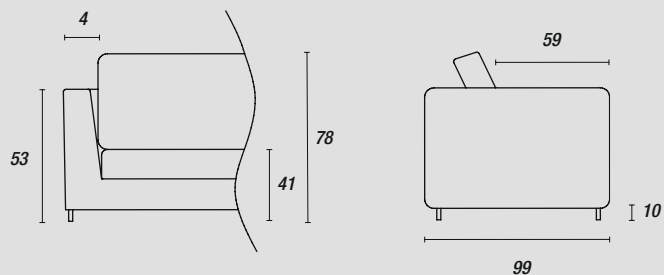

Feet - Pieds::

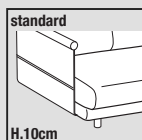

Black (ME09)



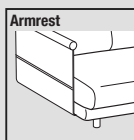









Accessories - Accessoires:

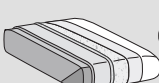

Natural (CR01)
Brown (CR02)
Taupe (CR03)
Grey (CR05)
Dark brown (CR08)
Hemp (CR10)

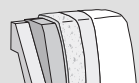
Althon low



	Seat - Assise	Backrests - Dossiers	Structure - Structure	
Upholstering Revetement (12)	Removable <i>Déhoussable</i>	 		
	Not removable <i>Non déhoussable</i>	—		
Padding Rembourrages (5-6-7-8-9-10-11)	   D.35/50kg/m ³	 +  D.25-30kg/m ³	 Polyurethane foam	 optional

TECHNICAL INFORMATION

Structure: 1-2-3

Supporting structure in various thickness spruce and beech. Sides and partition in class E1 particleboard panels, details in hardboard panels or cellulose panels.

Springing: 1-4

The back is made of hard or cellulose wooden fibre panels. The seat is supported by propylene and latex elastic belts.

Note:

ALTHON arm available in recycled bonded leather in natural (CR01), brown (CR02), taupe (CR03), grey (CR05), dark brown (CR08), hemp (CR10); the stitching on the arm is in the same shade as the leather, in the rounded part there are closing plugs in stainless steel finish (2).

In the fabric version use only Miami fabric for the insert (14). In the leather version the insert it is not available.

INFORMATIONS TECHNIQUES

Structure: 1-2-3

Parties de soutien en bois de sapin et étre de différentes épaisseurs. Cotes latéral en panneaux de particules de bois en classe E1, particuliers en panneaux de fibre de bois dure ou cellulose.

Suspension: 1-4

Dossier en panneaux de fibre de bois dure ou cellulose. Assise avec sangles élastiques de fibre propylénique et latex.

Note:

Accoudoirs ALTHON disponibles en cuir régénéré dans les couleurs naturel (CR01), marron (CR02), tourterelle (CR03), gris (CR05), marron foncé (CR08) et chanvre (CR10); la couture sur l'accoudoir est toujours en teinte avec le cuir, sur la partie arrondie sont présentes des bouchons de fermeture en métal finition inox (2).

Dans la version en tissu pour l'insert (14) utiliser uniquement le tissu Miami. Dans la version en cuir l'insert ce n'est pas disponible.

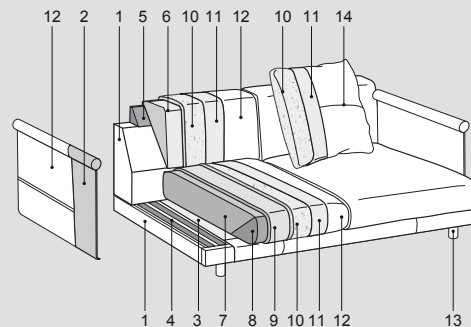
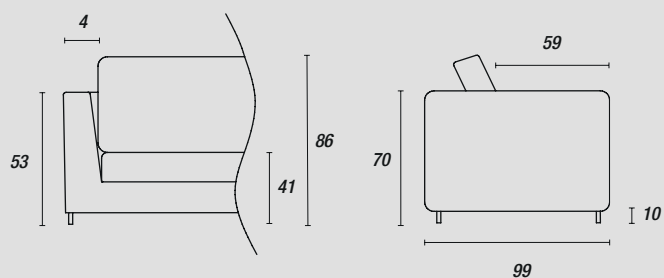

Feet - Pieds::

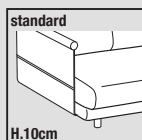

Black (ME09)

Accessories - Accessoires:

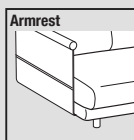

Natural (CR01)
Brown (CR02)
Taupe (CR03)
Grey (CR05)
Dark brown (CR08)
Hemp (CR10)