













St. Germain

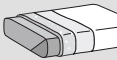

	Seat - Assise	Backrests - Dossiers	Structure - Structure	
Upholstering Revetement (9)	Removable <i>Déhoussable</i>	 		
	Not removable <i>Non déhoussable</i>	—		
Padding Rembourrages (3-4-5-6-7-8)	 +  D.35/40kg/m³	 +  D.25kg/m³	 +  Polyurethane foam	 ETHICALLY SOFT MADE optional

TECHNICAL INFORMATION

Structure: 1

Supporting structure of plywood and pinewood with parts of E1 class agglomeration panels or cellulose agglomeration panels.

Springing: 1-2

The back is made of multilayered wood or class E1 wood particleboard panels. Seat structure made of plywood or E1 class particle wood.

Note:

Metal varnished side foot bar with tip in chromed black (ME05) or optional gold finishing (ME10).

INFORMATIONS TECHNIQUES

Structure: 1

Structure porteuse en panneaux de bois multiplis et partie en sapin massif de différentes épaisseurs, panneaux de tamponnement de particules de bois en classe E1.

Suspension: 1-2

Dossier en panneaux de bois multiplis ou particules de bois en classe E1. Assise en panneau de fibre de bois ou de particules de bois en classe E1.

Note:

Pied à pont latéral en métal verni avec pointe en finition noir chromé (ME05) ou en option finition gold (ME10).

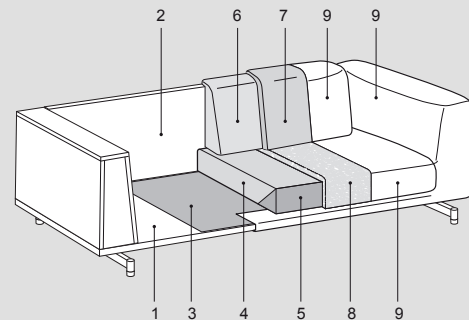
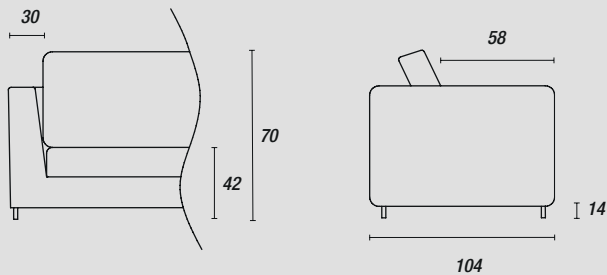

Feet - Pieds::

chromed black tip

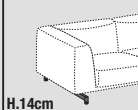

H.14cm
Black (ME09)

optional punt. gold

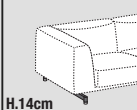

H.14cm
Black (ME09)

Accessories - Accessoires:

Top

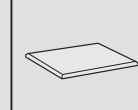

Eucalyptus (LE05)
Grey wood (LE12)