

orloital

Design by
Studio deFORM

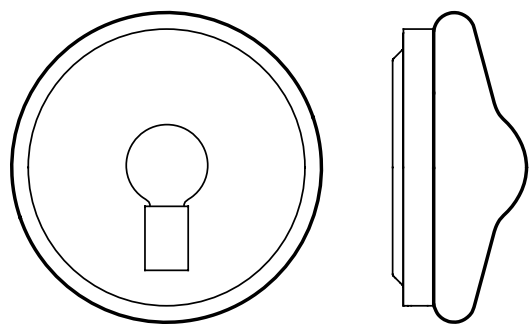

bomma

bomma.cz

TECHNICAL SHEET

ORBITAL

wall & ceiling lighting

Design by
Studio deFORM

Handmade glass attributes

All Bomma products are hand-made from mouth-blown lead-free crystal. Therefore any small bubbles, non-melts and irregularities in the glass are both proof and a characteristic feature of this traditional craft.

The Orbital Collection is made by underlying colored glass technology. Thanks to the manual process of blowing underlay glass, each piece is an original. Individual products may vary slightly in intensity, hue or even color. This is an accompanying characteristic of the traditional underlay glass technology.

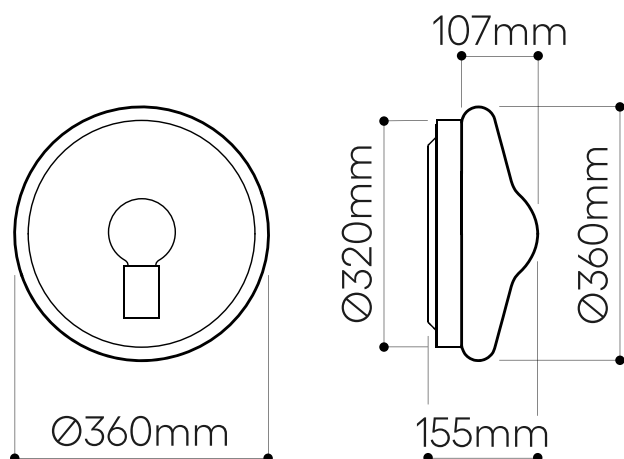

LIGHTING DESCRIPTION

Size	360 × 155 × 360 mm 14,2 × 6,1 × 14,2 inch
Weight	+/- 6,8 kg / 15 lb
Glass	mouth-blown lead-free crystal with in Moon clear, Venus pink, Polaris white, Mercury black
Mounting	silver (polished stainless steel) patina gold (brushed stainless steel with nitride titan coating)
Protection	IP 20
Nominal voltage	220-240V / A.C. 50 hz (EU) 110-120 V / A.C. 60 Hz (USA)
Class	I. EU / I. USA

LIGHT SOURCE

Type	G80, 6W LED, 510 lm
Base	E27 EU / E26 USA
Wattage	max. 13W
Temperature	2700 K
Color index	RA 90+
Dimming	Dimmable with TRIAC ; on demand dimmable with DALI, RF/WIFI, for information on dimming with other systems please contact your Bomma partner.

PACKAGING

Material	Cardboard
Size	510 × 430 × 430 mm 20,1 × 16,9 × 16,9 inch

Origin: traditionally produced in the Czech Republic
Intellectual property license holder: Bomma Czech Republic (EU)
Represented by BMRC group s.r.o.

CERTIFICATES

