

LASVIT PRAHA L MANUAL CE

Praha Collection
by Stanislav Libensky



The Beauty Of Glass

EN

Contents

Technical parameters	1
Step-by-step installation	2
Canopy disassembly	3
Fixing point preparation	4
Fixing	4
Installation of the glass components	7
Installation of the glass component assemblies ^{1,2,3}	24
Electrical wiring	27
Canopy mounting	29
Light source replacement	30
Installation notes	32
Warranties and Warranty Terms and Conditions	33

Markings

 Warning

Warns you of high risk of damage to the fixture or injury.

 Risk of electrical injury.

Warns you of high risk of electrical injury should a live part be directly or indirectly touched.

 Notice

Warns you about possible damage to the fixture.

 Important

Important information regarding the usage of your fixture.

 Note

Gives you general information about the usage of your fixture.

Please read this manual carefully and keep it in case you need assistance while performing maintenance and cleaning procedures.

LASVIT GLASS COLLECTIONS ARE UNIQUE AND HANDCRAFTED.

Tiny bubbles and other irregularities may occur due to the nature of the glass-blowing technique.

Thank you for purchasing a Lasvit Collection.

1/ Technical parameters

Item ID / CLo26SC-2CE

Color variants / clear

Light source / 3 × E27, 6 W

Input voltage / 220 – 240 V, 50/60 Hz

Rated power / max. 18 W

Protection rating / IP 20

Safety class / CLASS I

Dimensions / Ø 460 mm x OH 1520 mm

Weight / approx. 30 kg

2/ Step-by-step installation

 Before starting any procedures make sure that the power to the lighting fixture is switched OFF and secured against unauthorized, negligent or accidental switching on.

 Should the cable need to be shortened, ask a qualified technician (licensed electrician) to disconnect the cable, shorten it and reconnect it, detail instructions can be found in the chapter **Cable shortening**. The same applies to lengthening the cable, however a new, longer cable needs to be purchased separately. Lasvit shall not be held liable for any injuries or damage to the fixture or other property caused by unauthorised manipulation with the cable or its parts.

 To retain quality of hand-blown glass, Lasvit recommends to clean the glass at least every 3 months.

 Fixing material is not part of the lighting fixture kit. Refer to the relevant section of this manual for suitable fixing materials and components.

 Proper fixing shall be the responsibility of the customer.

 Installation and electrical wiring should be carried out by a qualified electrician to prevent any damage to health or property.

 The manufacturer shall not be held liable for any defects caused by unqualified handling of the lighting fixture.

 This lighting fixture is to be mounted on fire proof surfaces.

 Do not cover the lighting fixture with any material, it is necessary for the hot parts to be cooled by freely flowing air, otherwise there is a risk of fire.

 Do not spin the pendant ! Spinning the pendant may result in breaking of the suspension cable and/or electrical malfunction!

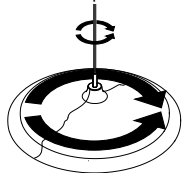

 For indoor use only. Installation requires 2 persons.

3/ Canopy disassembly

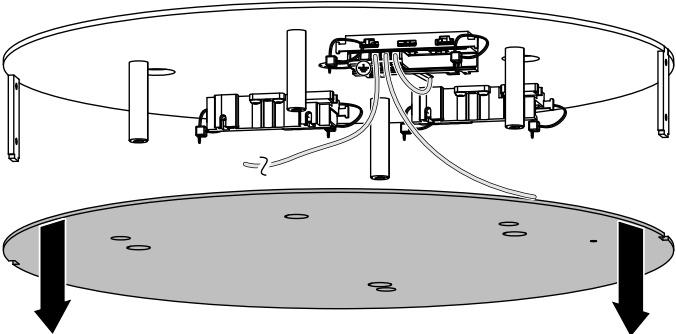
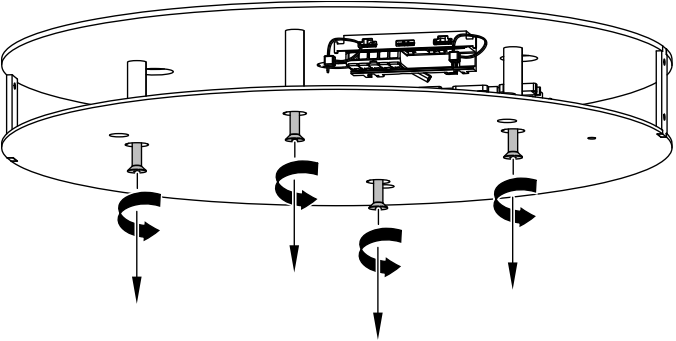

4/ Fixing point preparation

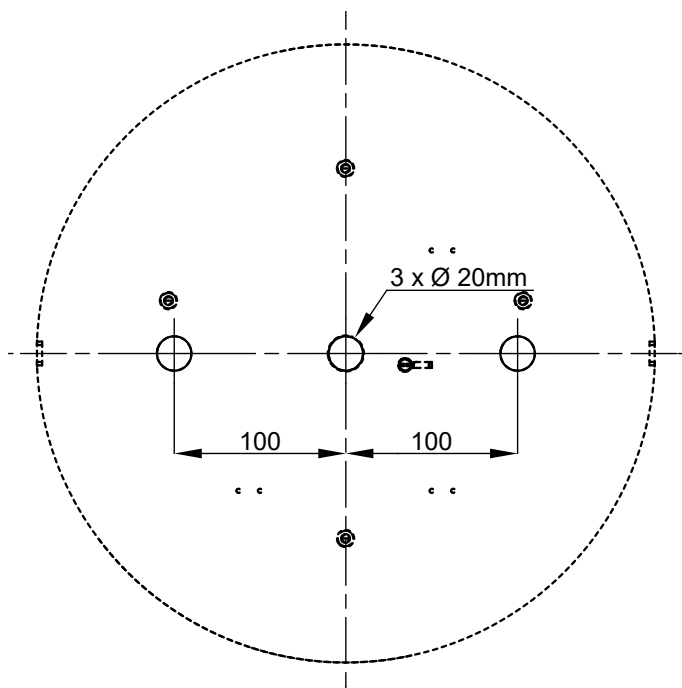

5/ Fixing

Fixing material is not included.

 Lasvit shall not be held liable for any injuries or damage to the fixture or other property caused during installation or by improper fixing. Consulting a specialist before choosing type of fixing materials and procedures for a given fixture is highly recommended.

Pictures shown are for illustration purposes only.

5.1/ Threaded rods

i power supply: SiHF 3x2,5 mm²

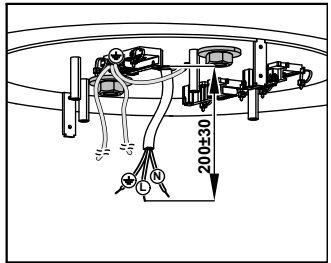
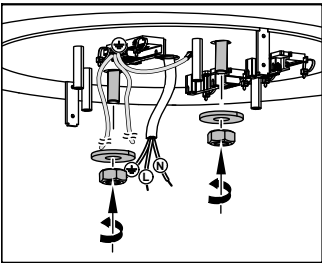
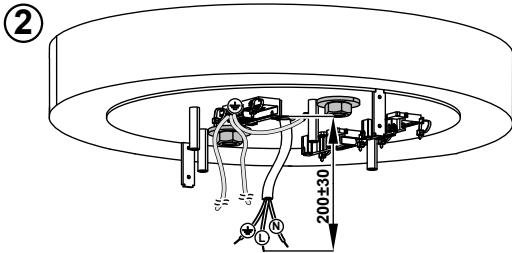
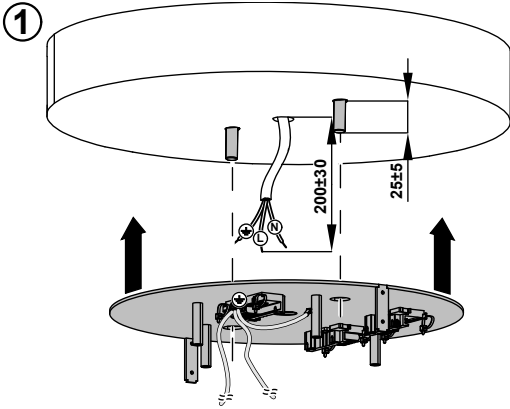

5.2/ Bolts/screws

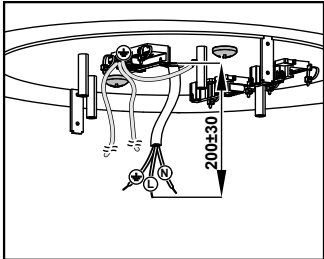
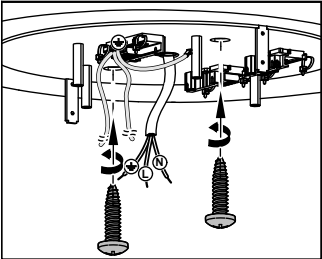
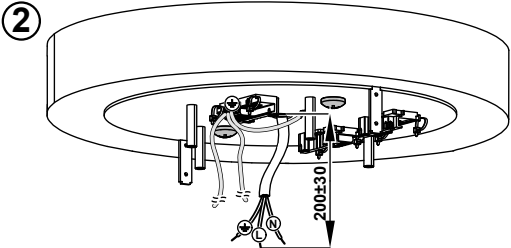
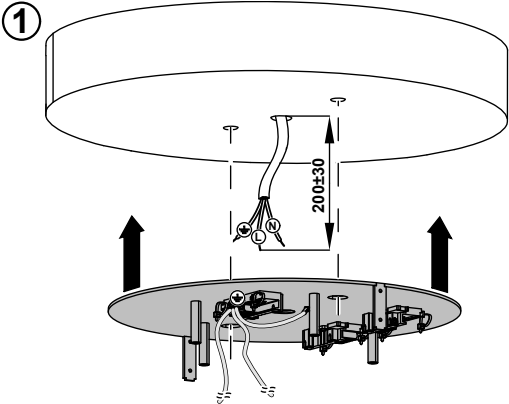

6/ Installation of the glass components

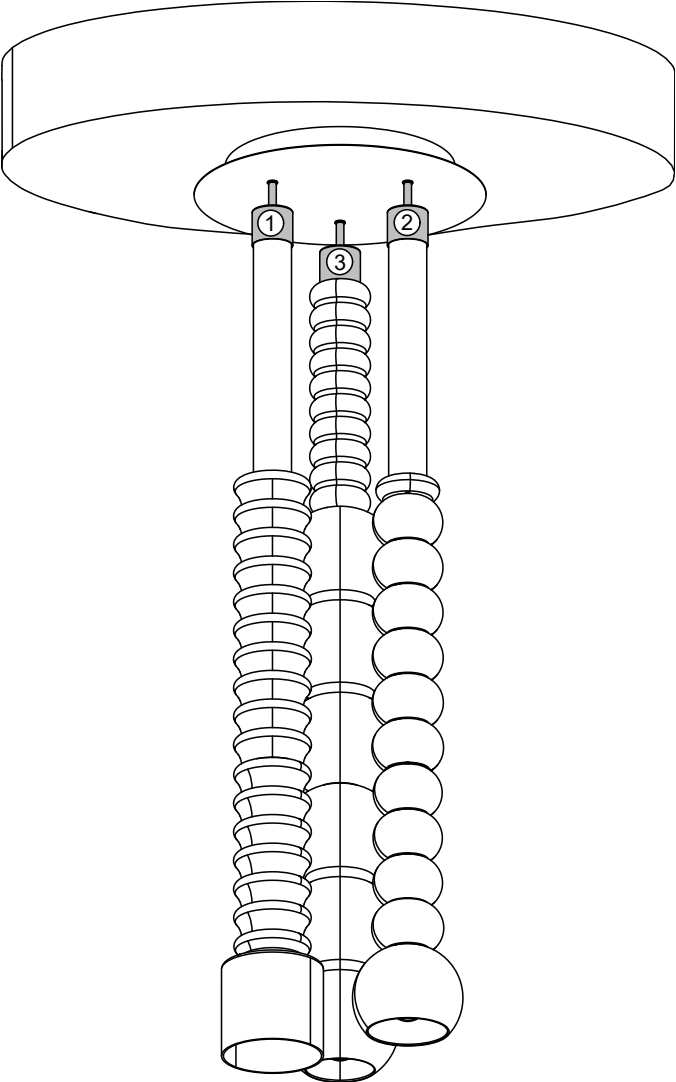

6.1/ Assembly 1

Step 1

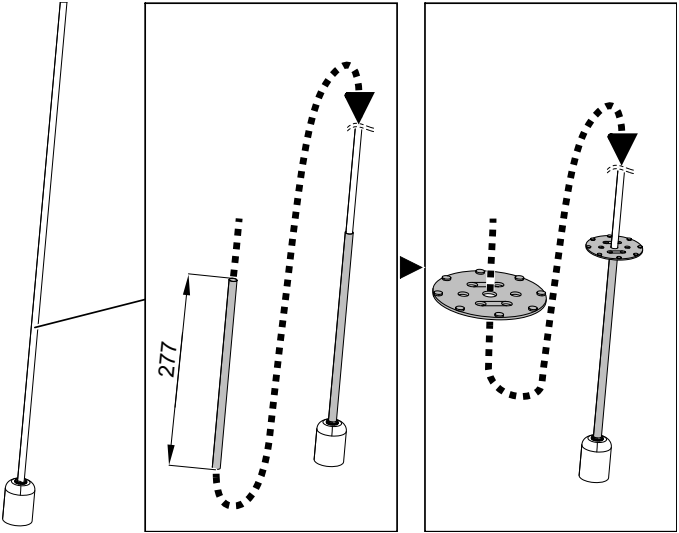

Step 2

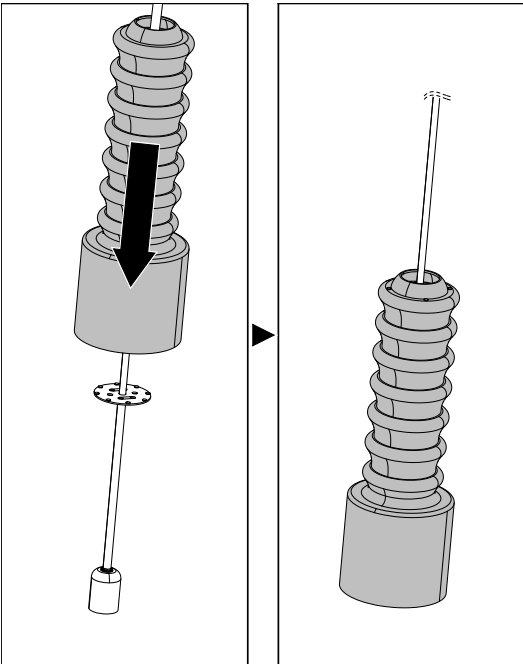

Step 3

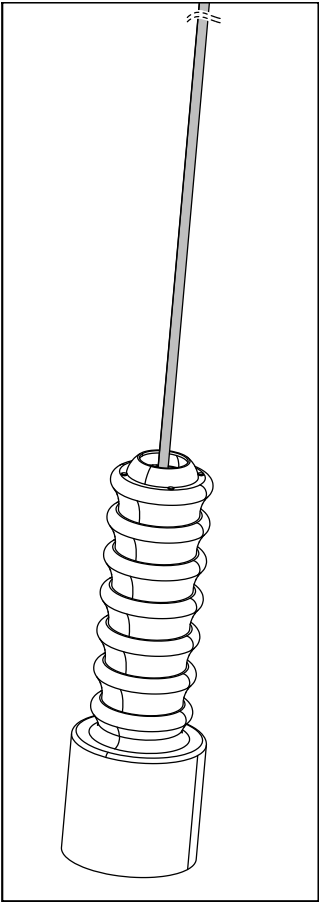
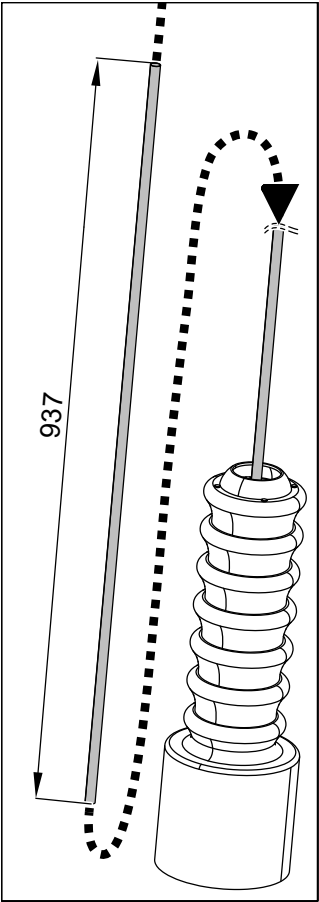

Step 4

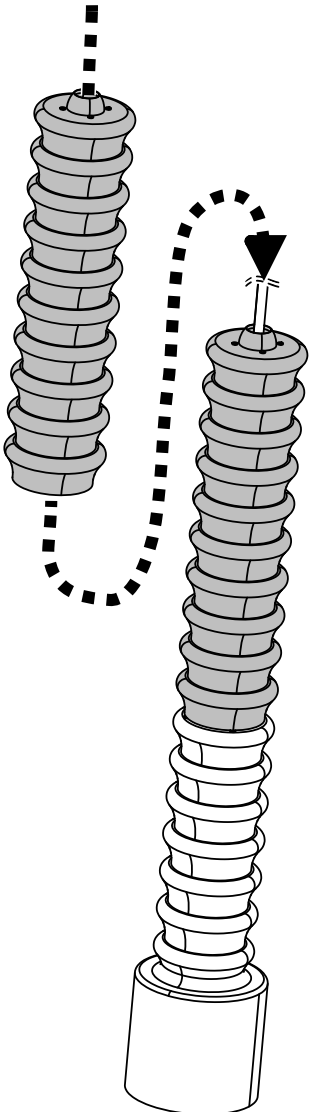

Step 5

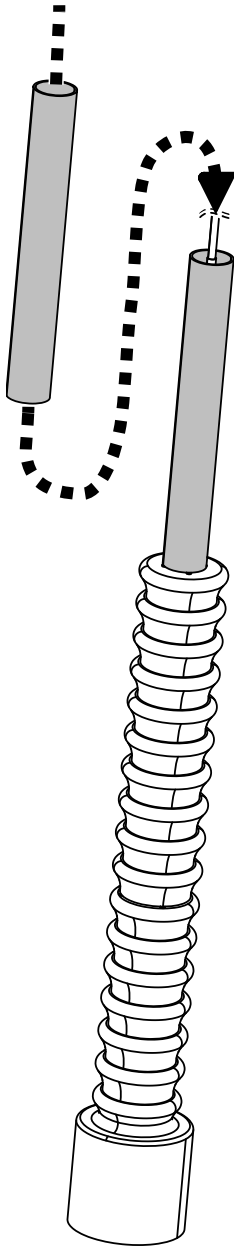

Step 6

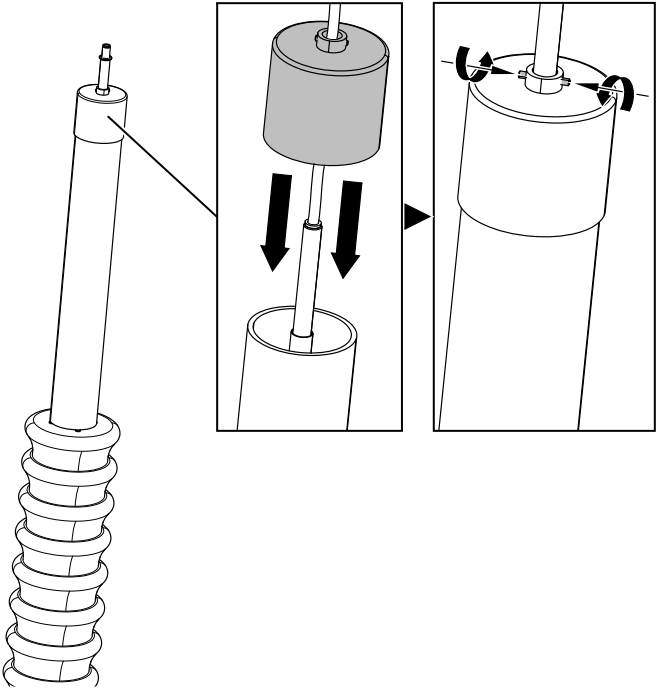

Step 7

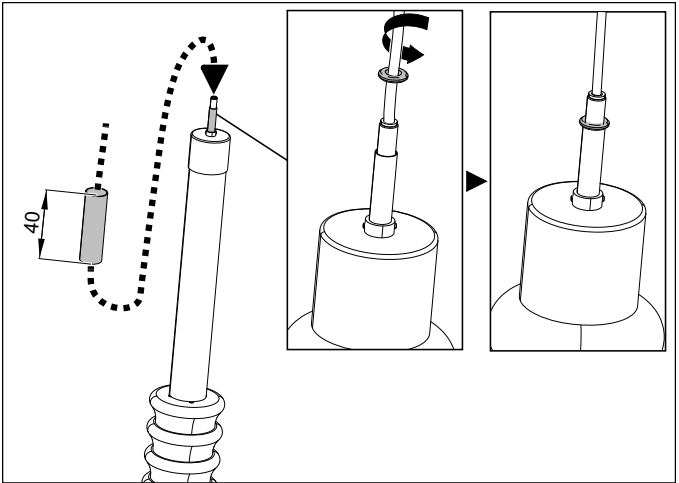

6.2/ Assembly 2

Step 8

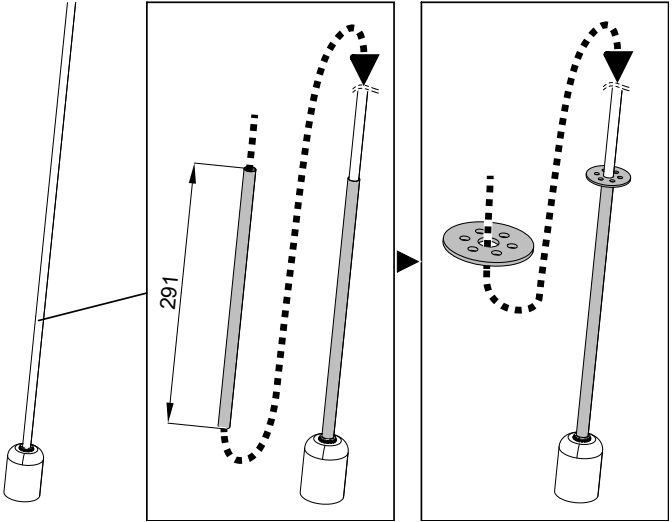

Step 9

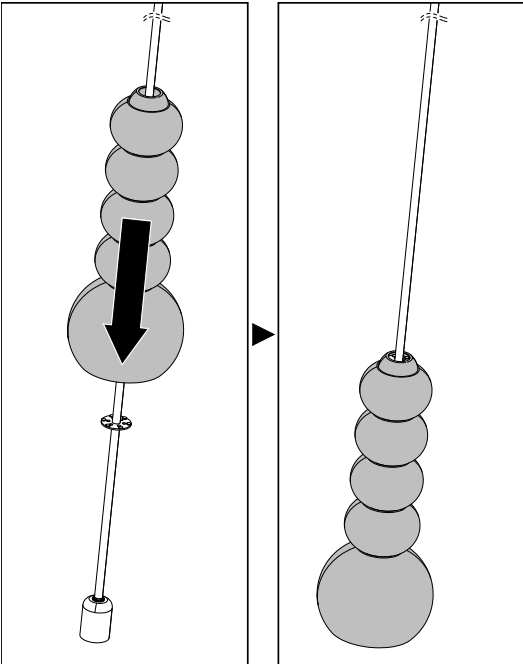

Step 10

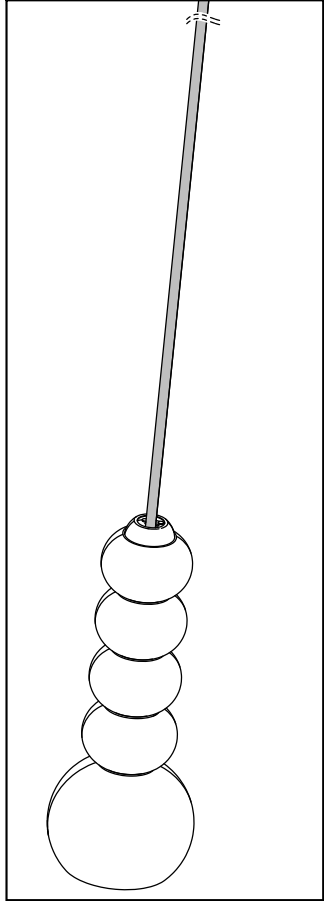
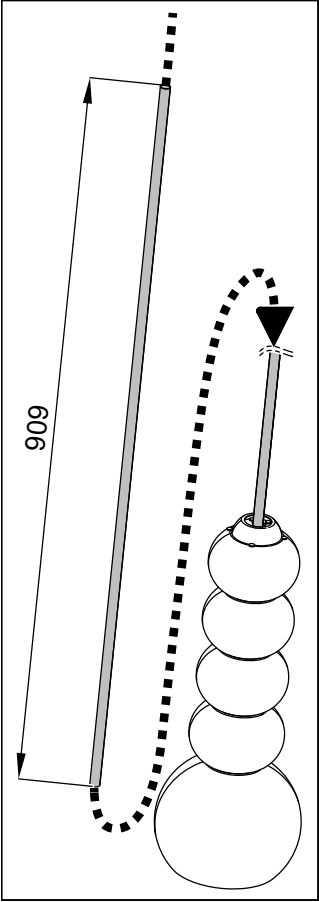

Step 11

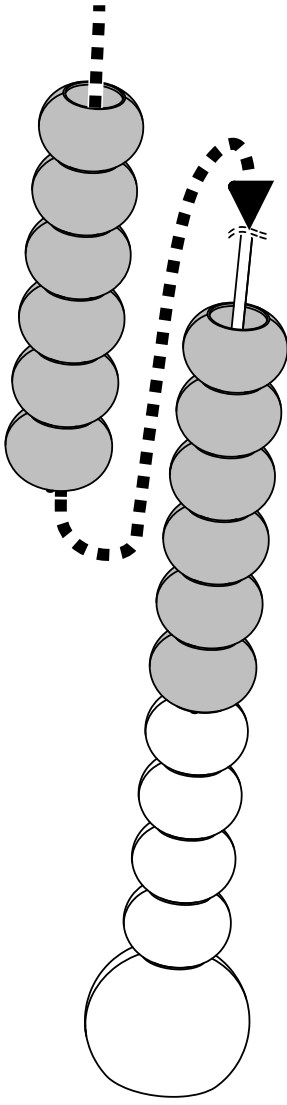

Step 12

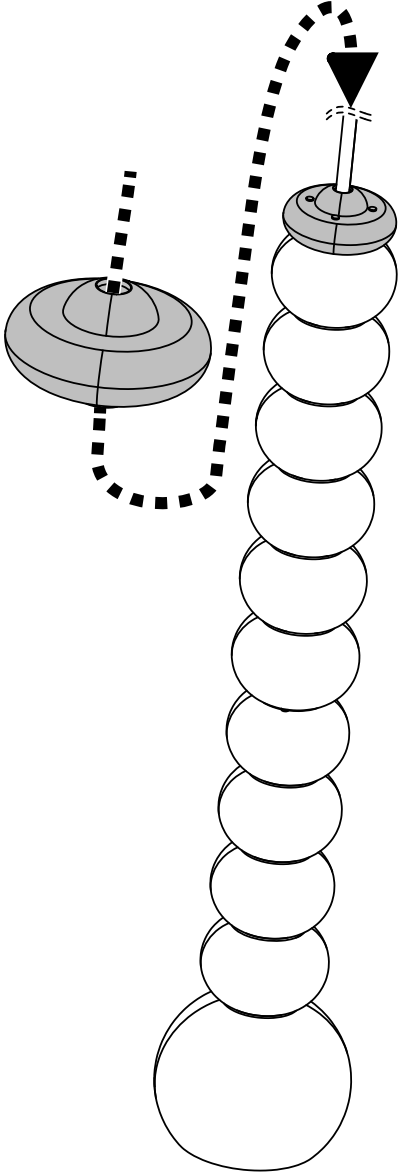

Step 13

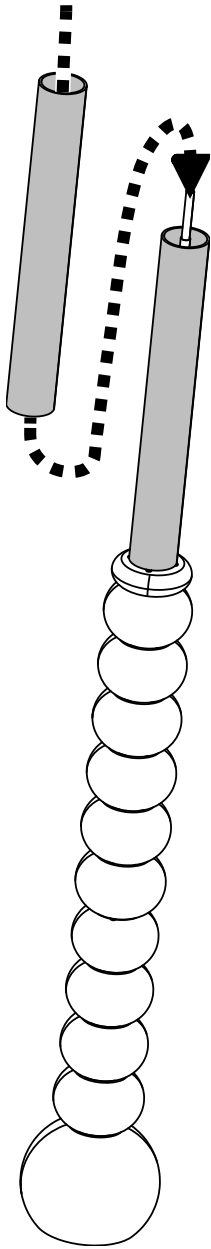

Step 14

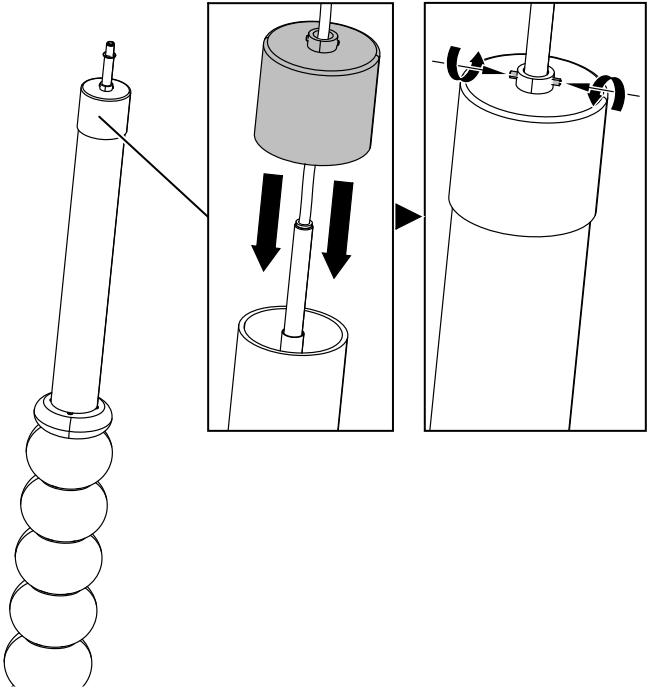

Step 15

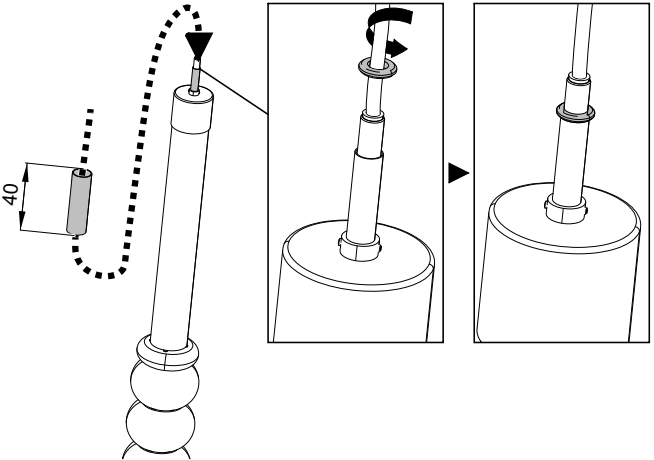

6.3/ Assembly 3

Step 16

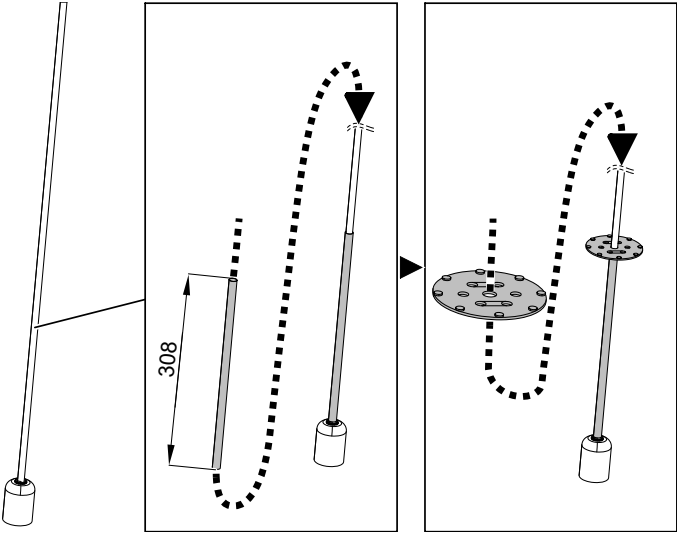

Step 17

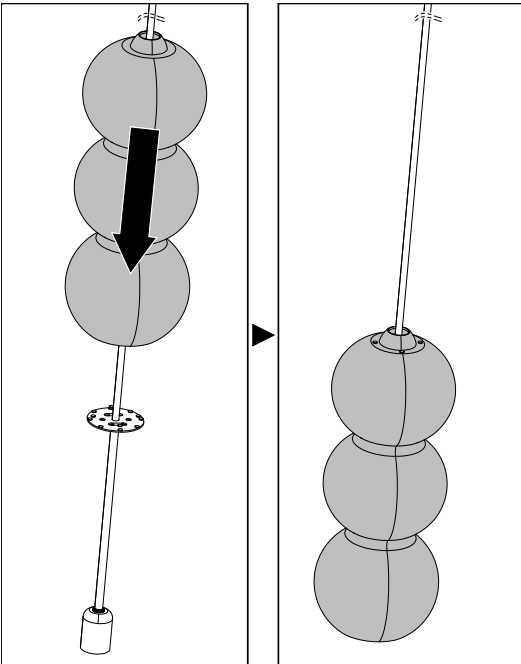

Step 18

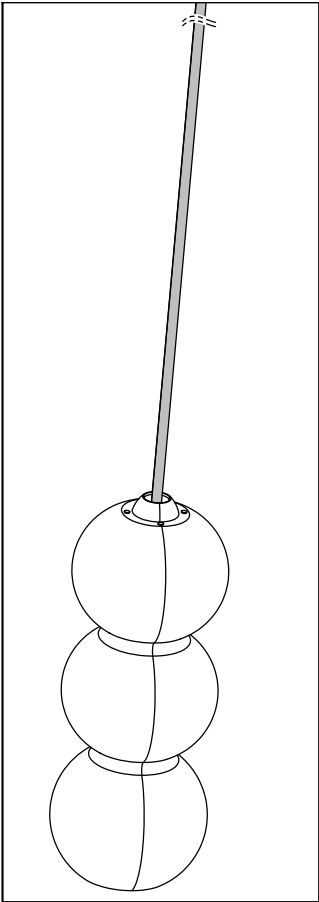
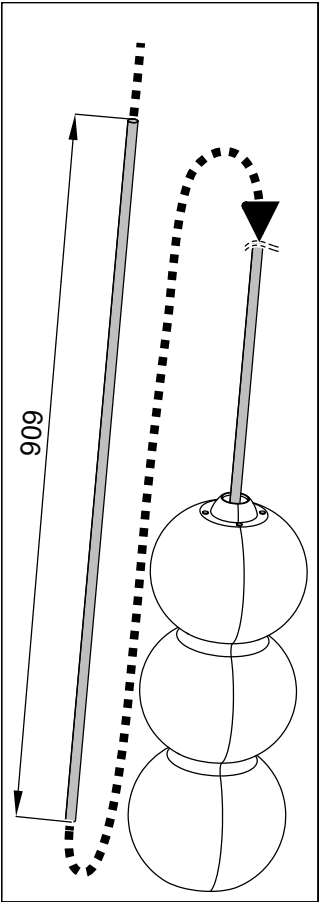

Step 19

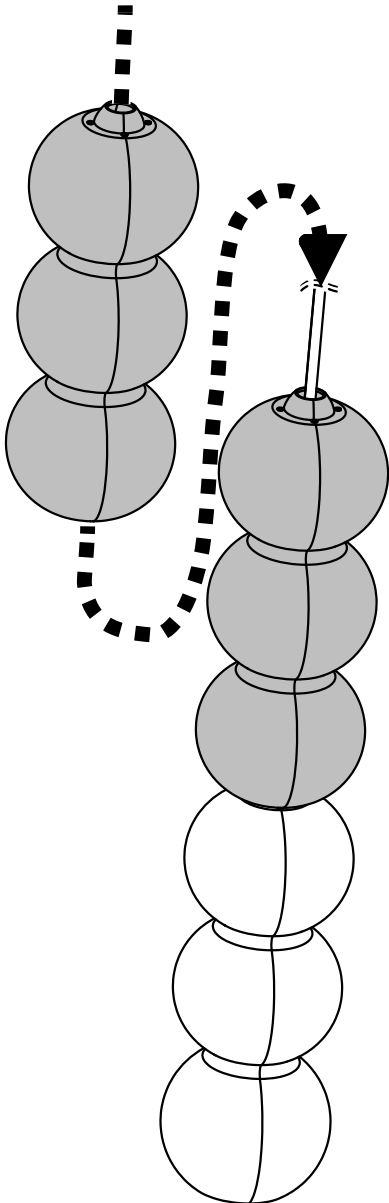

Step 20

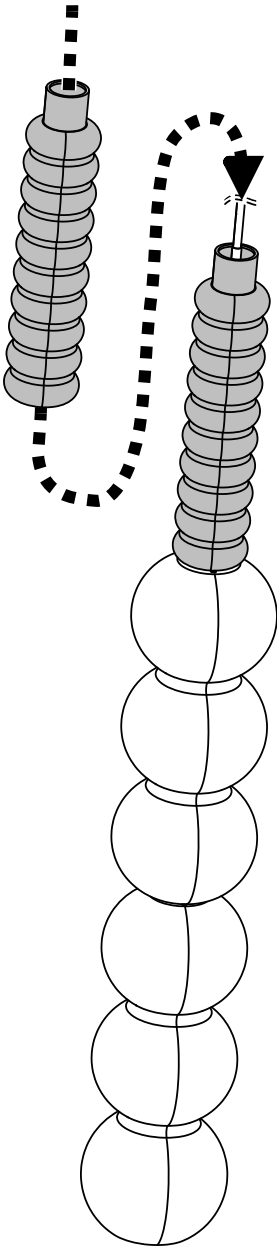

Step 21

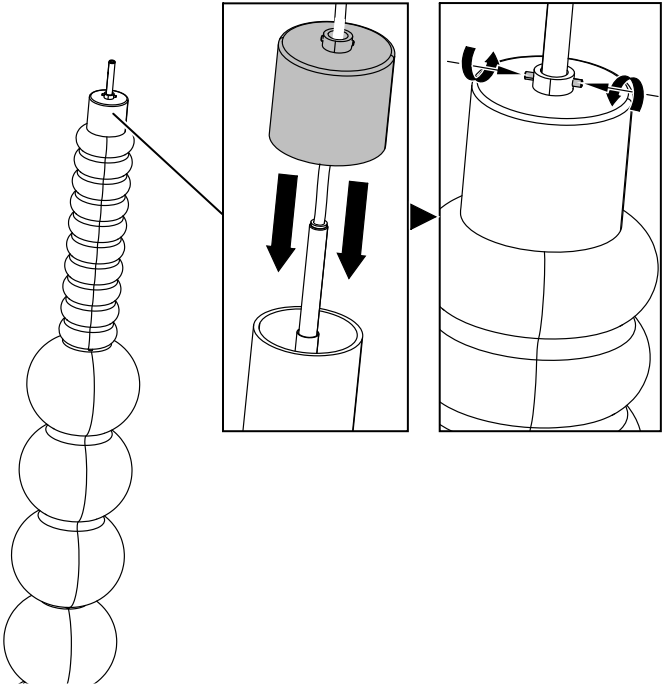

Step 22

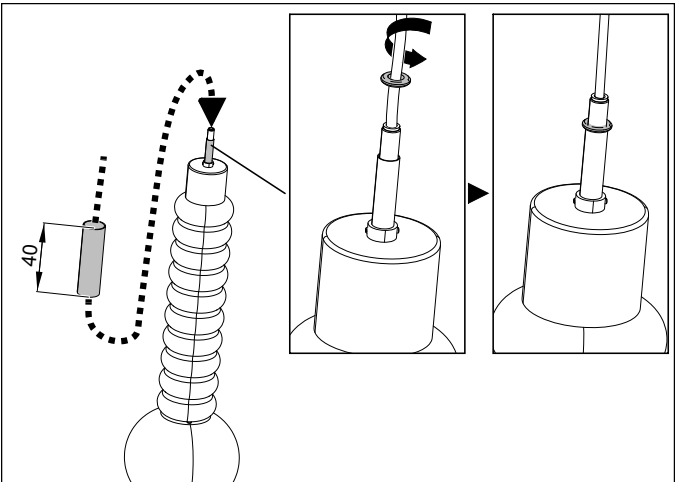

7/ Installation of the glass component assemblies^{1,2,3}

Step 23

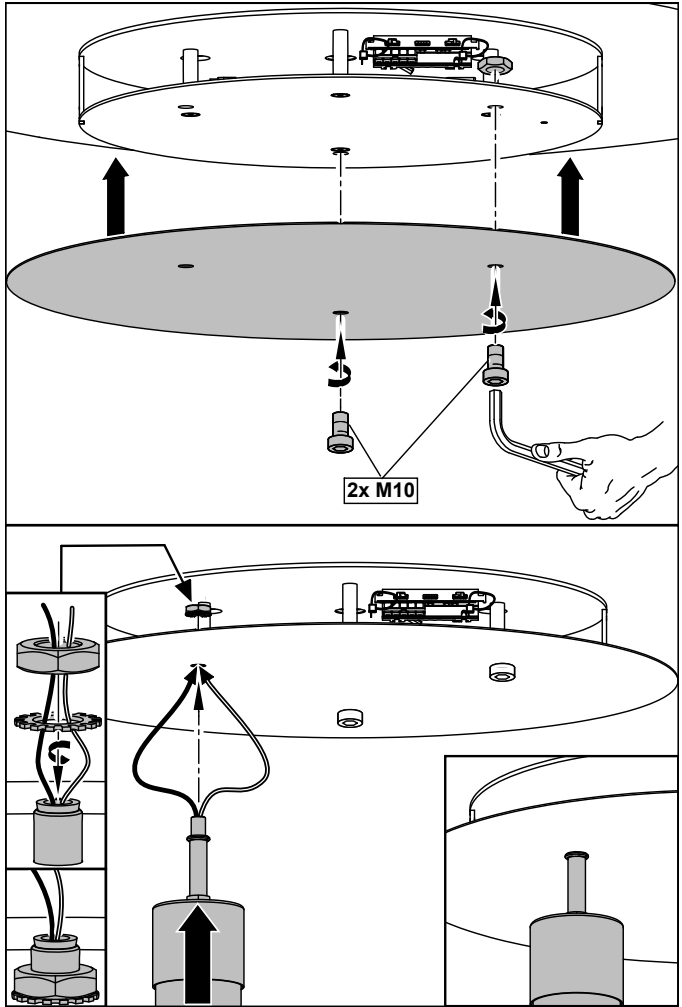

Step 24

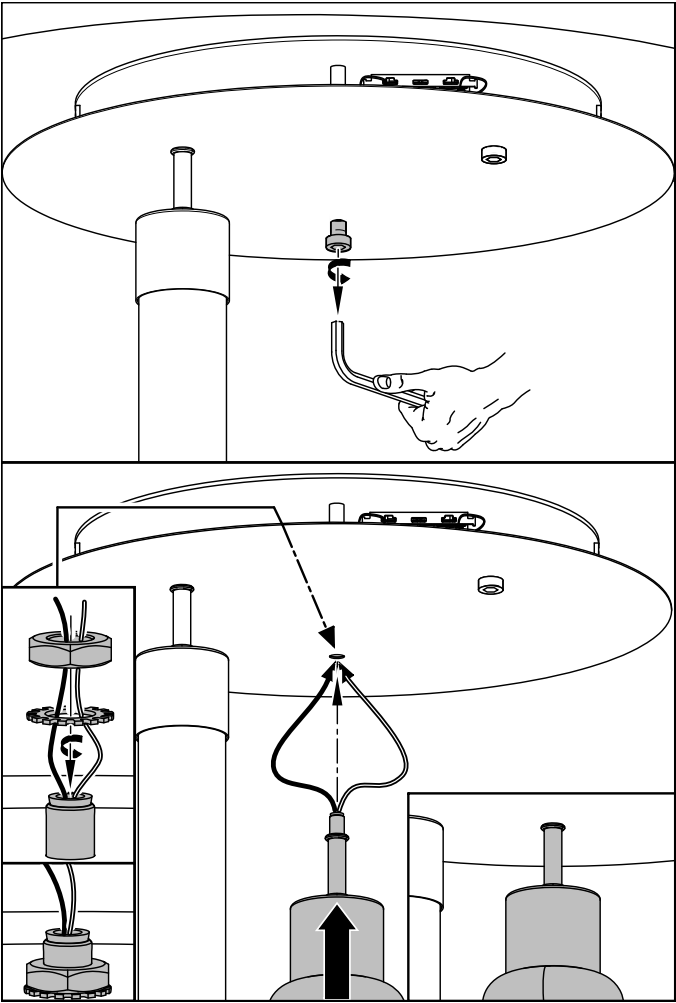

Step 25

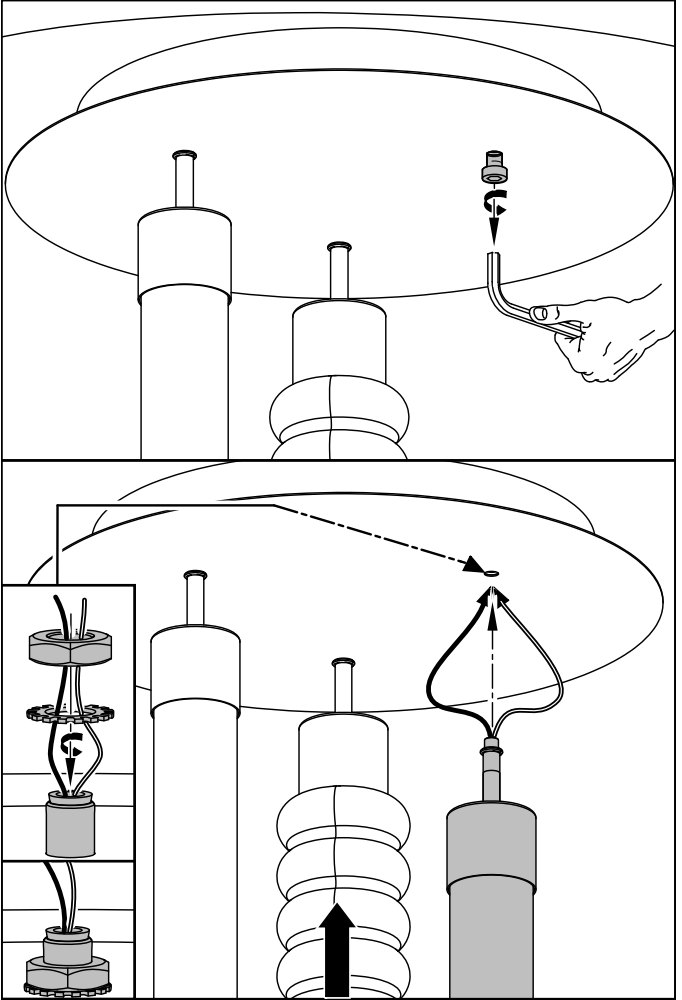

8/ Electrical wiring

Step 26

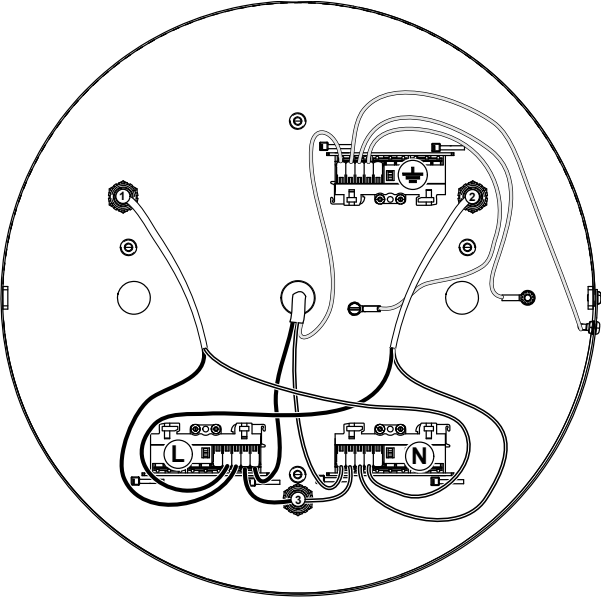

Step 27

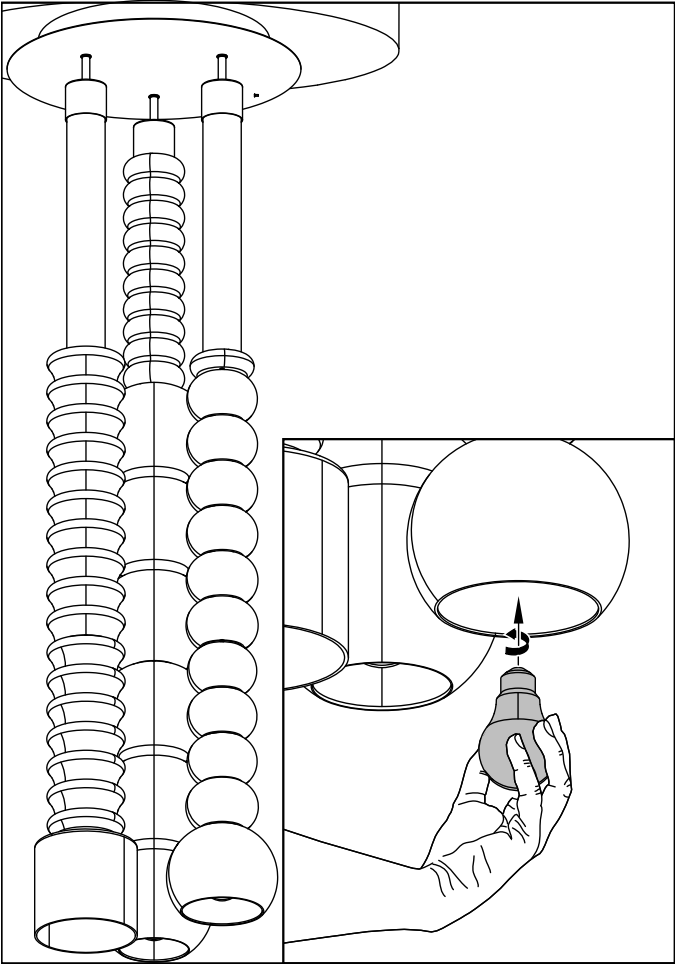

9/ Canopy mounting

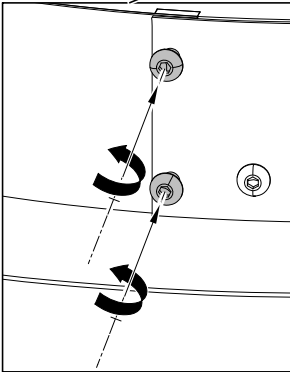
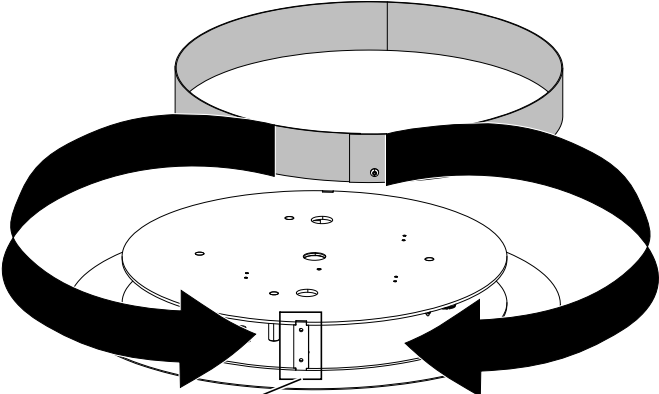

10/ Light source replacement

All light sources can be supplied by the manufacturer, Lasvit s.r.o.

Replacement of the bulb should be carried out by qualified technician to prevent damage to health or property.

Lasvit provides NO warranty on bulbs and is not responsible for any damage or injury caused during its installation or during its operation.

Before starting installation make sure the power to the lighting fixture is switched OFF and secured against unauthorized, negligent or accidental switching on.

The manufacturer shall not be held responsible for injuries, damage to the fixture and/ or other property when other than specified light source type and/ or rating is used.

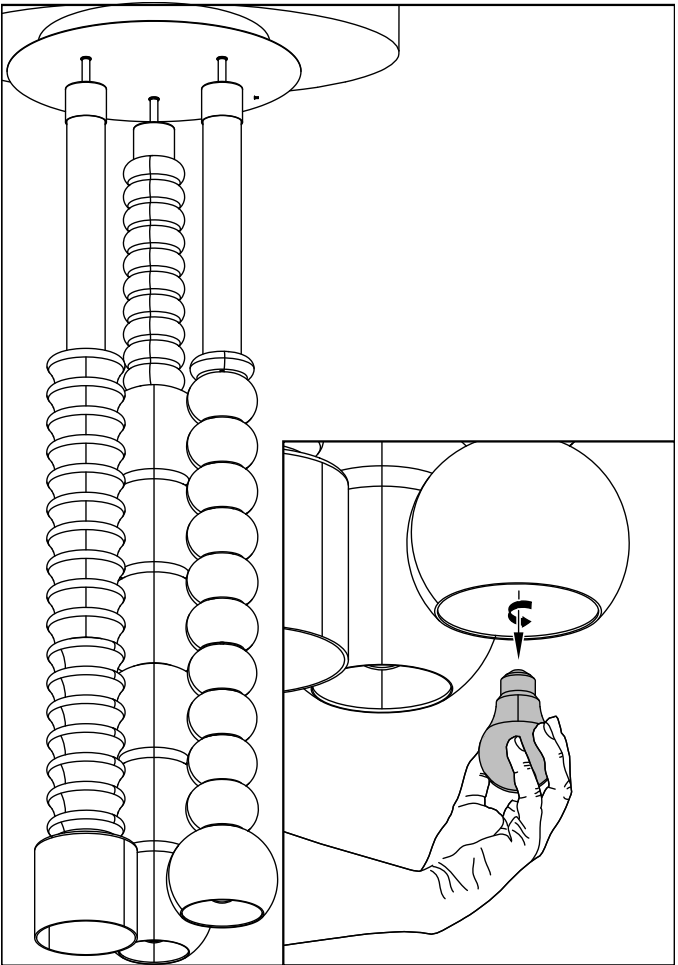



Carry out this step in reverse to fit the new bulb.

Plug in the light again.

11/ Installation notes

11.1/ Cable shortening

 This adjustment can be carried out only by a qualified electrician (trained electrician).

 Perform the cable adjustment according to valid standards.

Picture 1: Adjusted cable from the manufacturer (LASVIT).

Picture 2: Shortening the cable to the desired length.

Picture 3: Remove only the top insulation. The basic insulation of the conductor must not be broken.

Picture 4: Final adjustment of the cable for its connection. Additional insulation (positions F, G), stripped ends of wires with tubes.

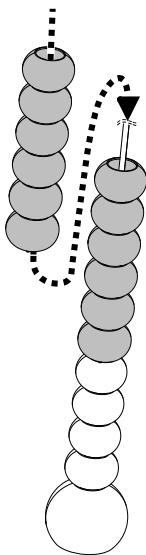

12/ Warranties and Warranty Terms and Conditions

1. The warranty is defined in Price Quotation (PQ) or in Purchase Agreement (PA). If **not stated otherwise**, the warranty shall not cover the **light sources**, maintenance, service and cleaning and the standard warranty shall be set at 2 years. Any other warranties must be specified in PQ or PA. The Customer must submit a valid agreement, invoice or another payment document as a base for any complaint.
2. If the warranty covers the detected defect, the Customer shall inform Sales (by e-mail or phone, defining the project / product number, the project / product name, the areas where the defect has emerged, and the sketch number. The Customer shall describe the defect).
3. Sales shall proceed based on the internal guideline for complaint management.
4. The Manufacturer shall analyze the origins of the defect either at the Customer's or at the Manufacturer's, after the defective product has been delivered to the Manufacturer's premises.
5. After the analysis, the decision about acknowledgement or refusal of the complaint and the respective explanation shall be passed on to Sales.
6. Sales shall submit information about acknowledgement / refusal of the complaint to the Customer within 7 workdays from reporting the defect at the latest. Sales shall agree further steps with the Customer (e.g. the date of repair, replacement, etc., based on the Customer's and Manufacturer's capacities). Unless agreed otherwise, the Manufacturer shall eliminate any defect within 30 days from the date of submittal of the complaint.
7. The complaints shall not cover any defects caused by the Customer, normal wear and tear, or by failure to follow the service manual or installation manual. The complaints shall not cover any defects caused by force majeure.
8. **The analysis may lead to the following conclusions:**

Manufacturer's fault:

- The product is repairable at the Customer's at the Manufacturer's cost.

- The product is repairable at the Manufacturer's at the Manufacturer's cost.
- The product is not repairable and shall be replaced by a tested functional one at the Manufacturer's cost.
- The product is not repairable and the Manufacturer cannot offer any replacement. The Manufacturer shall offer another product. The Customer shall accept the offer and settle the new product by a difference payment, or the Manufacturer shall pay a difference payment to the Customer.
- The product is not repairable and the Manufacturer cannot offer any replacement. The Manufacturer shall issue a refund to the Customer.

Customer's fault:

- The product is repairable at the Customer's at the Customer's cost.
- The product is repairable at the Manufacturer's at the Customer's cost.
- The product is not repairable and shall be replaced by a verified and functional one at the Customer's cost.
- The product is not repairable and the Manufacturer cannot offer any replacement. The Manufacturer may offer another product for purchase.



Never dispose of this product in mixed municipal waste, it must be submitted at the designated disposal installation.

The fixture was designed and manufactured by /
Lasvit s.r.o. / Komunardů 32 / 170 00 Praha 7 /
Czech Republic T +420 481 120 810 / F +420 481 120 622 /
E lasvit@lasvit.com lasvit.com

Manual created

02.05.2022

In case you need any assistance or have any suggestion, please contact us at

lasvit.com