

mdf italia



© COPYRIGHT 2023 MDF ITALIA SRL SOCIETA' UNIPERSONALE

2017-2021

20.VENTI COLLECTION

Designed by 967ARCH

20.Venti is an office system with a linear, iconic, versatile design created by 967arch.

With a light structure, a contrast between full and empty, and quality materials and finishes, this is a contemporary interpretation of the desk, the archetypical workstation. Available in a wide range of sizes and colours, 20.Venti includes individual tables, double and quadruple workstations, a high workstation, and flexible combinations designed to adapt to spaces and the teams that use them.

Combined with various accessories, 20.Venti allows to create a welcoming, functional space for working agilely and productively. In 2020, 20.Venti was selected for the 26th ADI Compasso d'Oro.

Discover "[20.Venti Home](#)" and "[Home Light](#)", the new compact and versatile options of the iconic 20.Venti family.

20.VENTI

FRAME AND TOP

Steel frame and legs, section 20x20 mm, painted with epoxy powder in the matt colours white and graphite grey. Structural wireway made of medium density fibreboard two-tone surfaced panels, thickness 2 cm, with the outside in matt colours white or graphite grey, and the inside always in medium grey. Tops are made of medium density fibreboard panels covered with Fenix NTM laminate in the matt colours white, light grey, medium grey and black.

Fenix NTM top in the colours pale grey and medium grey certified in compliance with standard UNI EN 13772 and UNI EN 13721.

DIMENSIONS AND TYPES

- . Single desk H75, dim. 90x160, 90x180 and 90x200 cm.
- . Workstation two users H75, dim. 160x160 and 160x180 cm.
- . Workstation four users H75, dim. 160x320 or 160x360 cm.
- . Flex workstation H75, table depth 160 cm, in sizes that can be customised as required by using terminal or intermediate modules in the lengths 160 or 180 cm.
- . High workstation H110, dim. 100x160, 100x180 and 100x200 cm.

Adjustable aluminium foot with range of +/- 1 cm.

The single desk, the workstation two and four users and the workstation Flex have a structural wireway that can be accessed by sliding the top. It can be used for electrification and cables.

ACCESSORIES

Open compartment, sound-absorption screen, PC stand with castors, wireway sleeve, stationary and document holder.

Available by project, partition with steel cables and two accessories for the structural wireway: the valet tray shelf and laptop or tablet bag (for min. 20 pieces).

20.VENTI LIGHT

FRAME AND TOP

Matt white, light grey or black melamine tops. Steel frame and legs, section 20x20 mm, painted with epoxy powder in the matt colours white and graphite grey.

DIMENSIONS AND TYPES

- . Single Desk H75, dim. 90x160 and 90x180 cm.
- . Light workstation two users H75, dim. 160x160 and 160x180 cm.
- . Light workstation four users H75, dim. 160x320 or 160x360 cm.
- . Light Flex workstation H75, table depth 160 cm, in sizes that can be customised as required by using terminal, or intermediate modules in the lengths 160 or 180 cm.

Adjustable aluminium foot with range of +/- 1 cm.

Equipped with cable opening on the top.

ACCESSORIES

- . Finishing panels for the side frames of workstations.
- . Transparent plastic cable spring with aluminium painted base.
- . Under-top tray for cable collection.

SINGLE DESK

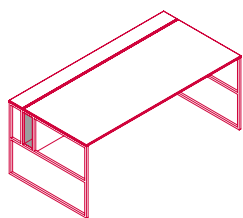

160

180

200

L160 D90 H75
L180 D90 H75
L200 D90 H75

WORKSTATION TWO USERS

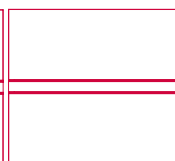
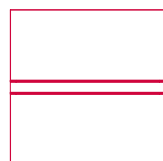
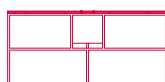
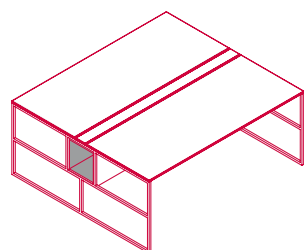

160

180

L160 D160 H75
L180 D160 H75

WORKSTATION FOUR USERS

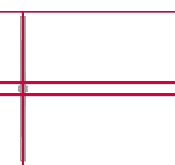
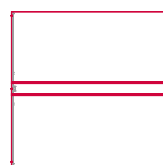
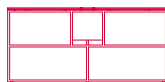
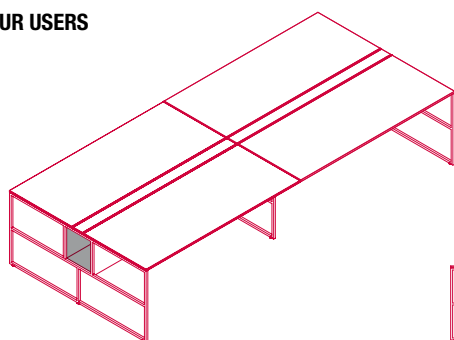

L320 D160 H75
L360 D160 H75

WORKSTATION FLEX

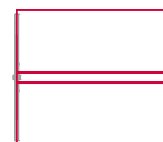
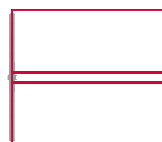
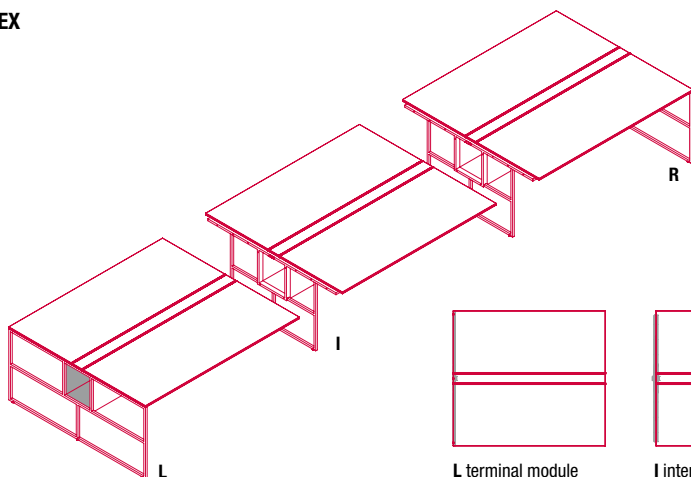

L terminal module

I intermediate module

R terminal module

L160 D160 H75
L180 D160 H75

20.VENTI



HIGH WORKSTATION

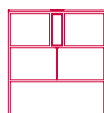
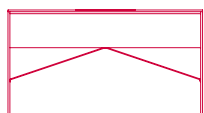
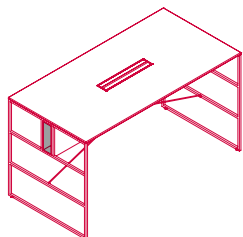

160



180



200

L160 D100 H110
L180 D100 H110
L200 D100 H110

20.VENTI HOME

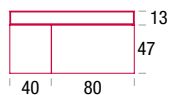
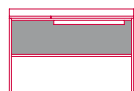
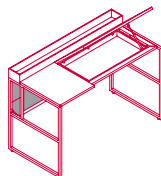
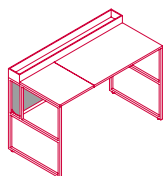

L120 D60 H75 / 81.5

SINGLE DESK FRAME

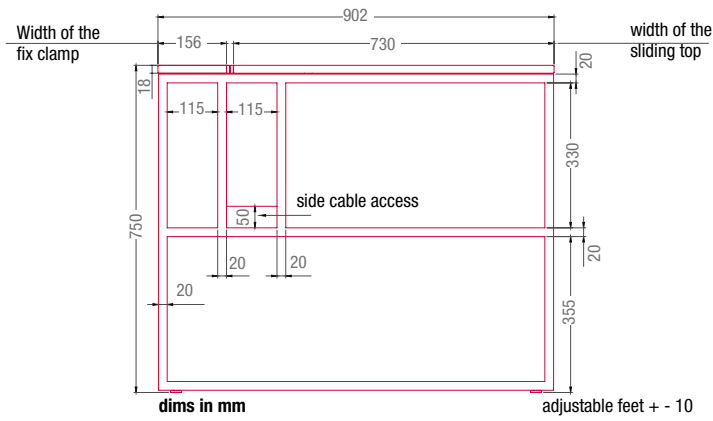

SINGLE DESK SLIDING TOP

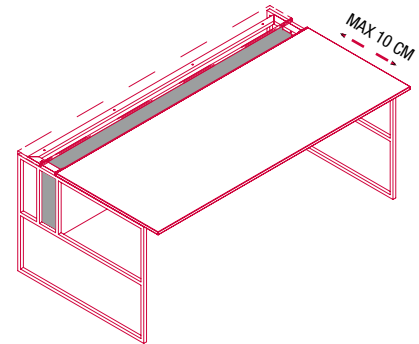

DESKS WITH FRONT SEATS FRAME

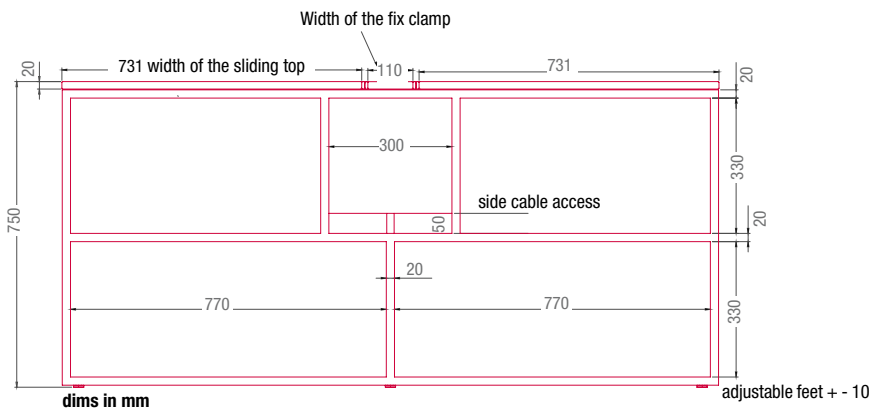

DESKS WITH FRONT SLIDING TOP

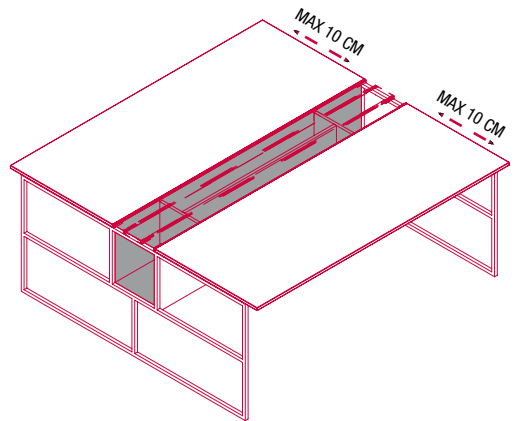

HIGH TABLE BAR/OFFICE

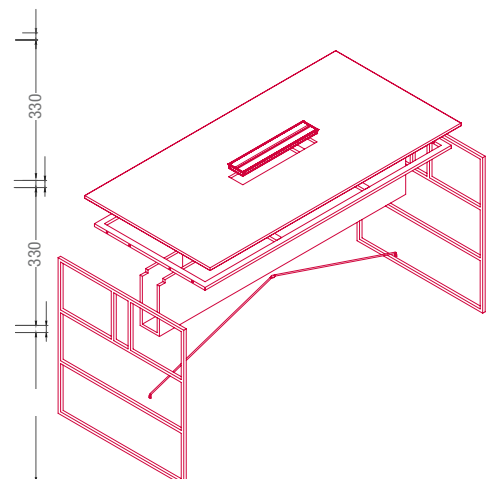
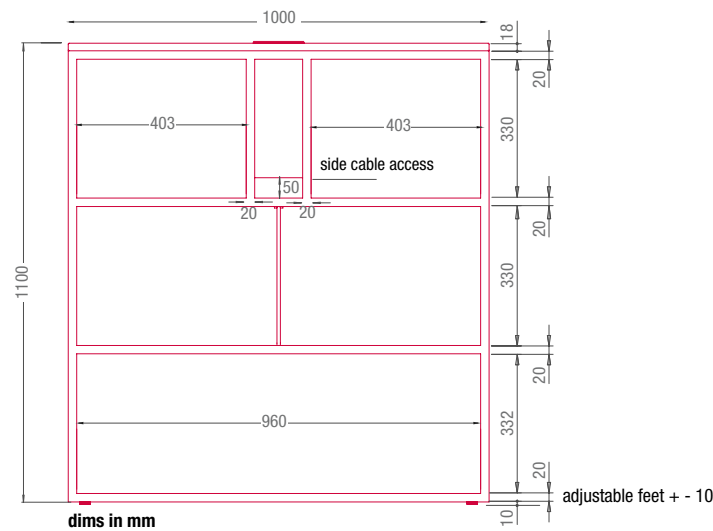

HOW TO USE THE ACCESSORIES

cablе scheme and use of the internal cabinet without accessories

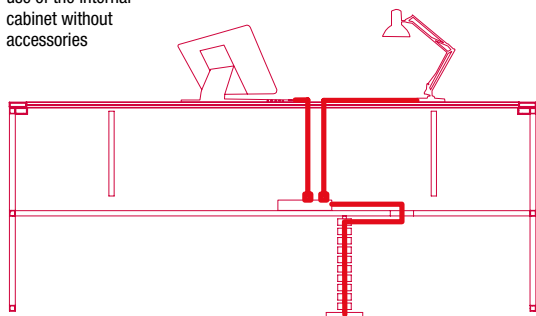

cablе scheme and use of the accessories inside the internal cabinet

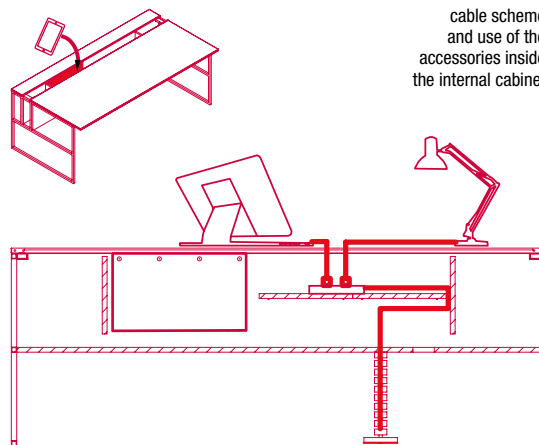

SOUND-ABSORPTION SCREEN

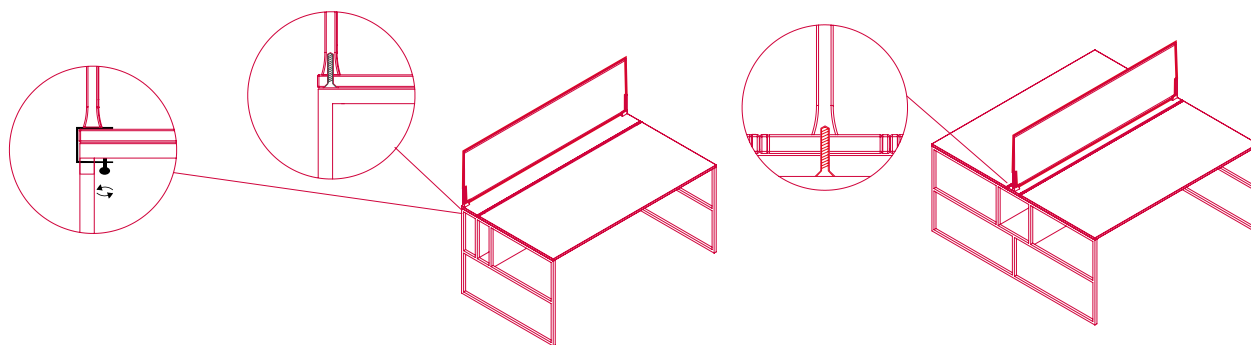

OPEN COMPARTMENT

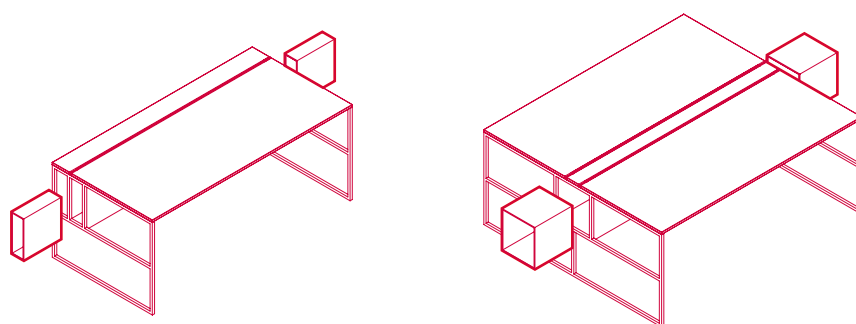

Finishing

The number in the dot corresponds to the number of colour/material finish.

Here below, in the section FINISH OPTIONS, please note all the colours of the materials used for this product.

20.VENTI

Top



Fenix

Structure

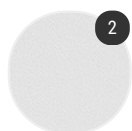

Matt painted

Open compartment



Matt lacquered

20.VENTI LIGHT

Top



Melamine

Structure

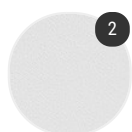

Matt painted

20.VENTI LIGHT PANEL FINISHES

Structure



Melamine

Finish options

TOP

Fenix



Fenix matt
white X020



Fenix matt
light grey

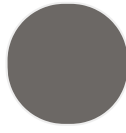

Fenix matt
medium grey
X021

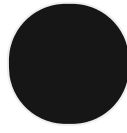

Fenix matt
black X022

Melamine



Matt
melamine
white

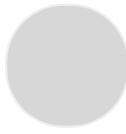

Matt
melamine
light gray

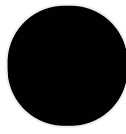

Matt
melamine
black

STRUCTURE

Matt painted



Matt painted
white X053



Matt painted
graphite grey
X054

Melamine



Matt
melamine
white

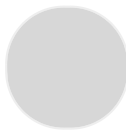

Matt
melamine
light gray

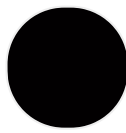

Matt
melamine
black

OPEN COMPARTMENT

Matt lacquered



Matt painted
white X042



Matt
lacquered
dune X162



Matt
lacquered
burgundy
X163



Matt
lacquered
English green
X164



Matt
lacquered
navy blue
X165