

FLEXFORM

FLEXFORM | MADE IN ITALY



FEEL GOOD LARGE | FEEL GOOD TEN LARGE
ANTONIO CITTERIO **2009 | 2010**

DIVANI | DIVANI COMPONENTI | POUF SOFAS | SECTIONAL SOFAS | OTTOMANS

FLEXFORM Spa

Via Einaudi 23/25 20821 Meda (MB) Italy | Tel. +39 0362 3991 | Fax +39 0362 399228 | info@flexform.it | www.flexform.it

FEEL GOOD LARGE | FEEL GOOD TEN LARGE | ANTONIO CITTERIO | 2009 | 2010

TIPOLOGIE DIVANI/DIVANI COMPONIBILI/POUF
- POLTRONE/POUF - POLTRONCINE/SEDIE/
SGABELLI

PRODOTTO DIVANO - DIVANO COMPONIBILE

STRUTTURA TELAIO SEDUTA

IN METALLO RIVESTITO IN CUIOIO

NELLE SEGUENTI FINITURE: BIANCO(5007)

- GRIGIO(5003) - TESTA DI MORO(5004)

TESTA DI MORO SCURO(5013) - NERO(5005)

- OLIVA(5006) - ROSSO BULGARO(5008) -

SABBIA(5001) - TABACCO(5015) VERSIONE

SCAMOSCIATO: MORO(6004) - NERO(6005)

- OLIVA(6003) - SABBIA(6001), CON

MATERASSINO IN POLIURETANO

TELAIO SEDUTA / F.G. TEN IN METALLO

RIVESTITO IN TESSUTO CON MATERASSINO IN
POLIURETANO.

BRACCIOLI E SCHIENALE IN LEGNO CON
IMBOTTITURA INPOLIURETANO E DACRON
RIVESTITI IN TESSUTO PROTETTIVO

ACCOPIATO

CUSCINI SEDUTA IN POLIURETANO

E DACRON

CUSCINI SCHIENALE IN PIUMA

CUSCINETTI IN PIUMA SU RICHIESTA CON
SUPPLEMENTO DI PREZZO

PIEDI IN METALLO SATINATO - CROMATO

- BRUNITO - CHAMPAGNE - CROMATO

NERO O IN METALLO RIVESTITO IN CUIOIO

NEI SEGUENTI COLORI: BIANCO(5007)

- GRIGIO(5003) - TESTA DI MORO(5004)

TESTA DI MORO SCURO(5013) - NERO(5005)

- OLIVA(5006) - ROSSO BULGARO(5008) -

SABBIA(5001) - TABACCO(5015) VERSIONE

SCAMOSCIATO: MORO(6004) - NERO(6005) -

OLIVA(6003) - SABBIA(6001)

RIVESTIMENTO TESSUTO SFODERABILE O

PELLE NON SFODERABILE.

CATEGORIES SOFAS/SECTIONAL SOFAS/
OTTOMAN - ARMCHAIR/OTTOMAN - CHAISE
LONGUES/DORMEUSE - SMALL ARMCHAIRS/
CHAIRS/STOOLS

PRODUCT SOFA - SECTIONAL SOFA

SEAT FRAME IN METAL

COVERED IN HIDE LEATHER: RUSSIAN

RED (5008), WHITE (5007), OLIVE (5006),

BLACK (5005), DARK BROWN (5004), DARK

BROWN EXTRA (5013), GREY (5003),

SAND (5001), TOBACCO (5015). ALSO

AVAILABLE IN BLACK SUEDE (6005),

DARK BROWN SUEDE (6004), OLIVE SUEDE

(6003), SAND SUEDE (6001).

WITH POLYURETHANE UNDERSEAT.

FRAME / F.G. TEN SEAT FRAME

IN METAL COVERED WITH FABRIC

WITH POLYURETHANE UNDERSEAT.

ARM AND BACKRESTS IN WOOD WITH

POLYURETHANE AND DACRON PADDING

COVERED WITH PROTECTIVE FABRIC LINING

SEAT CUSHION IN POLYURETHANE AND

DACRON

BACKREST CUSHION DOWN - FILLED

THROW PILLOWS DOWN-FILLED, ON

REQUEST WITH UPCHARGE

FEET IN SATINED, CHROMED,

BURNISHED, CHAMPAGNE OR BLACK

CHROMED METAL, OR COVERED

WITH HIDE LEATHER:

RUSSIAN RED (5008), WHITE (5007),

OLIVE (5006), BLACK (5005), DARK BROWN

(5004), DARK BROWN EXTRA (5013),

GREY (5003), SAND (5001), TOBACCO (5015).

ALSO AVAILABLE IN BLACK SUEDE (6005),

DARK BROWN SUEDE (6004), OLIVE SUEDE

(6003), SAND SUEDE (6001)

UPHOLSTERY REMOVABLE FABRIC

OR NOT REMOVABLE LEATHER COVERS.

PRODUKTARTEN SOFAS/ECKSOFAS/ HOCKER
- SESSEL/HOCKER - ARMLEHNSTUHL/STUHL/
HOCKER

PRODUKT SOFA - ECKSOFA

GESTELL METALLGESTELL MIT KERNLEDER

BEZOGEN IN DEN FARBEN: WEISS (5007),

GRAU (5003), TESTA DI MORO DUNKELBRAUN

(5004), TESTA DI MORO EXTRA DUNKELBRAUN

(5013), SCHWARZ (5005), OLIVGRÜN (5006),

BULGAREN ROT (5008), SAND (5001),

TABAK (5015). WILDLEDER: TESTA DI MORO

DUNKELBRAUN (6004), SCHWARZ (6005),

OLIVGRAU (6003), SAND (6001).

POLYURETHANPOLSTERUNG.

GESTELL / F.G. TEN LARGE METALLRAHMEN

MIT STOFF BEZOGEN UND DÜNNER

POLYURETHANAUFPLAGE.

ARM- UND RÜCKENLEHNE HOLZRAHMEN MIT

POLYURETHAN- UND DACRONPOLSTERUNG

UND PASSENDEM STOFFSCHUTZBEZUG.

SITZKISSEN POLYURETHAN UND DACRON.

RÜCKENKISSEN DAUNENFÜLLUNG.

LOSE KISSEN DAUNENFÜLLUNG - SEPARAT

BESTELLBAR.

FÜSSE METALLFÜSSE, SATINIERT, CHROM,

SCHWARZ CHROM, BRÜNIERT ODER

CHAMPAGNER.

ALTERNATIV FÜSSE MIT KERNLEDER

BEZOGEN DEN FARBEN: WEISS (5007), GRAU

(5003), TESTA DI MORO DUNKELBRAUN (5004),

TESTA DI MORO EXTRA DUNKELBRAUN

(5013), SCHWARZ (5005), OLIVGRÜN (5006),

BULGAREN ROT (5008), SAND (5001),

TABAK (5015).

MIT WILDLEDER BEZOGEN: TESTA DI MORO

DUNKELBRAUN (6004), SCHWARZ (6005),

OLIVGRAU (6003), SAND (6001).

BEZÜGE ABZIEHBARE STOFFBEZÜGE

ODER NICHT ABZIEHBARE LEDERBEZÜGE

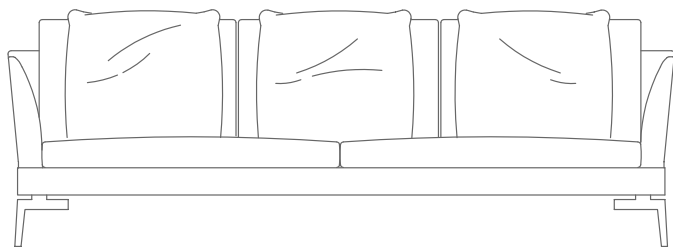



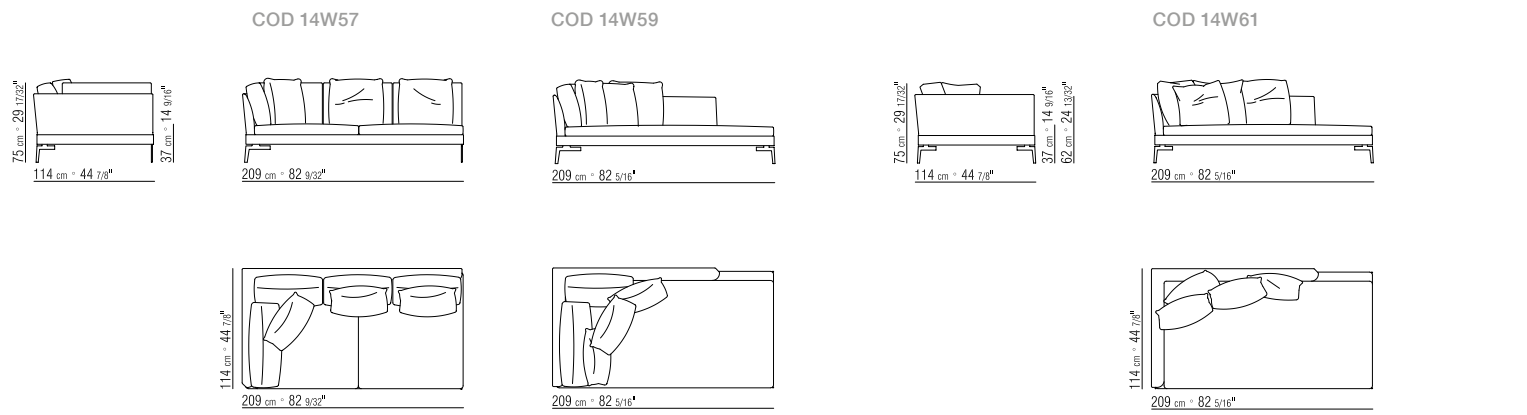
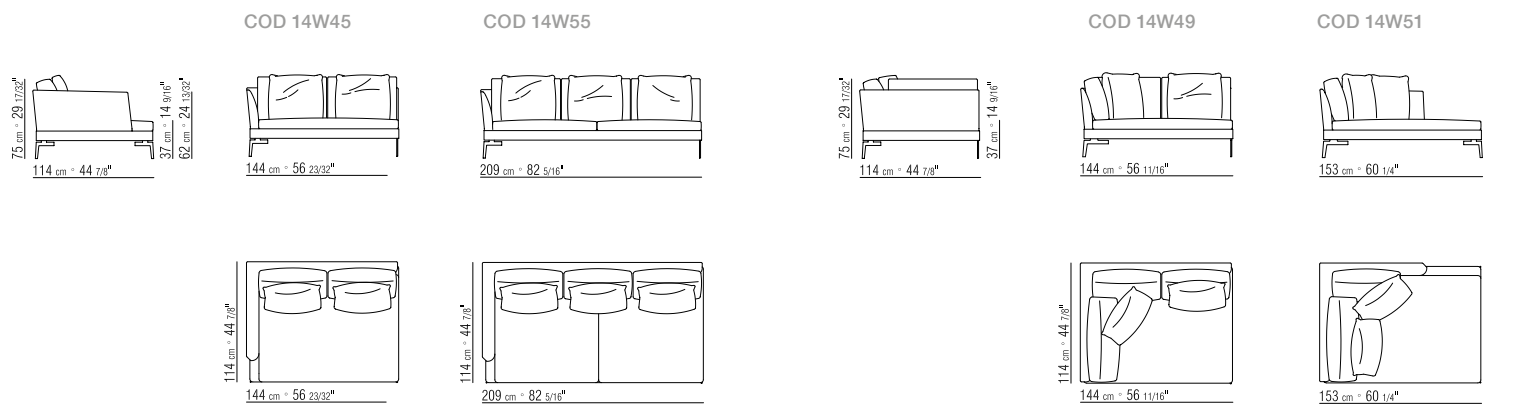
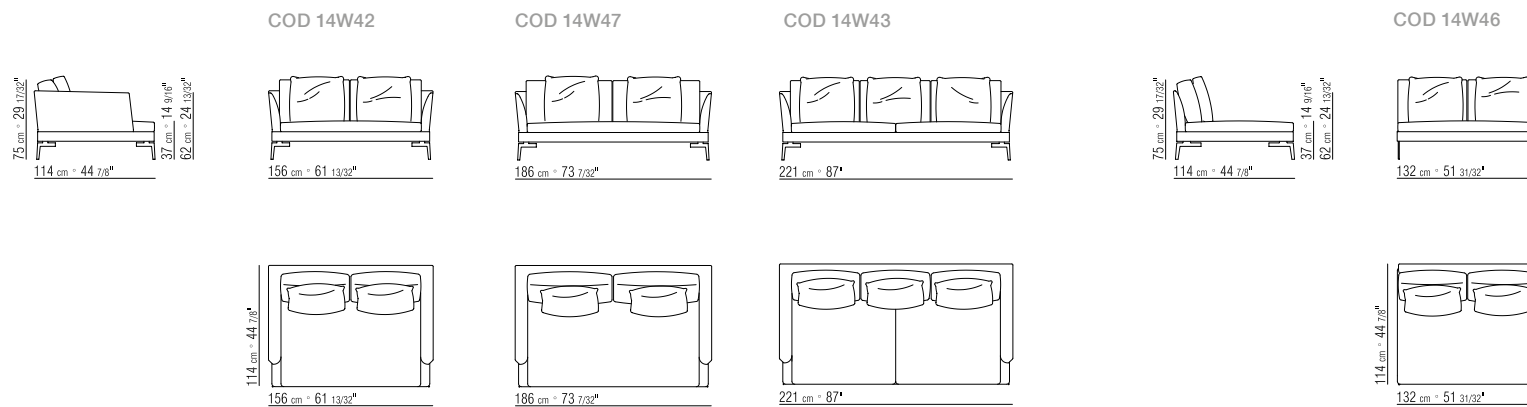

COD 15D42

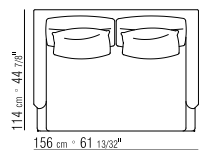
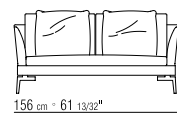
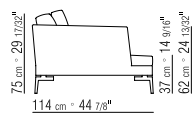

COD 15D47

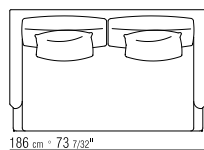
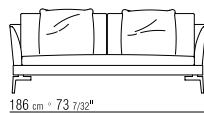

COD 15D43

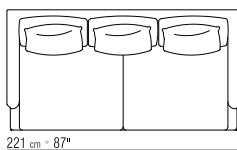
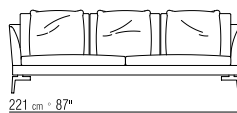

COD 15D46

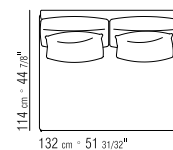
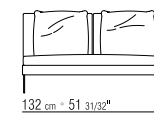
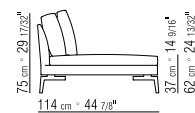

COD 15D45

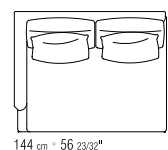
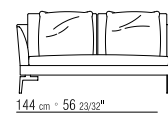
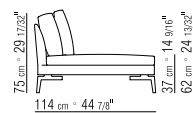

COD 15D55

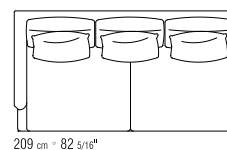
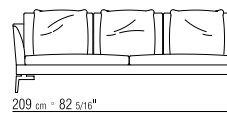
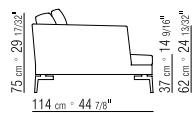

COD 15D49

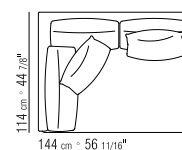
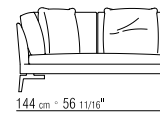
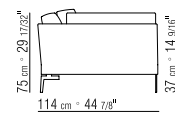

COD 15D57

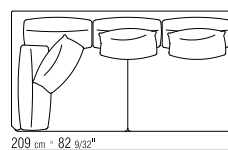
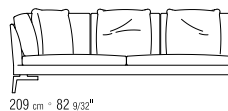
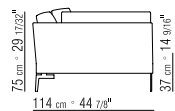

COD 15D51

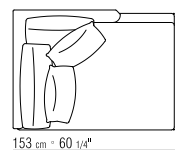
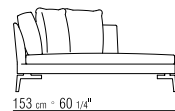

COD 15D59

