

MOSLEY

I VARI ELEMENTI CHE COMPONGONO IL DIVANO LETTO, FIANCHI E RETRO (D), CUSCINI DI SE-
DUTA E DI SCHIENALE (B), BRACCIOLI E BASE (C), TESTIERA (E-F) E BORDATURE (A), POSSONO
ESSERE RIVESTITI COMBINANDO LIBERAMENTE TRE DIVERSI COLORI E TESSUTI CREANDO
QUATTRO SOLUZIONI DI ABBINAMENTO.

SOLUZIONE 1

Solution 1_ Solution 1_

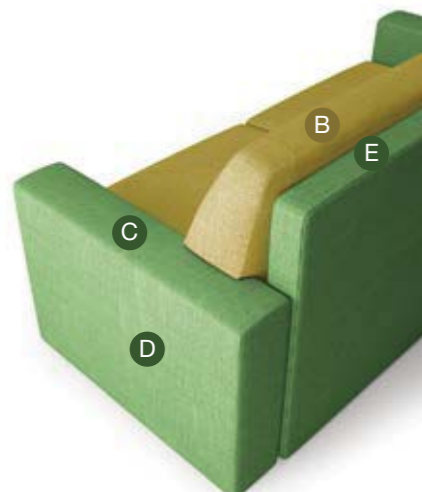
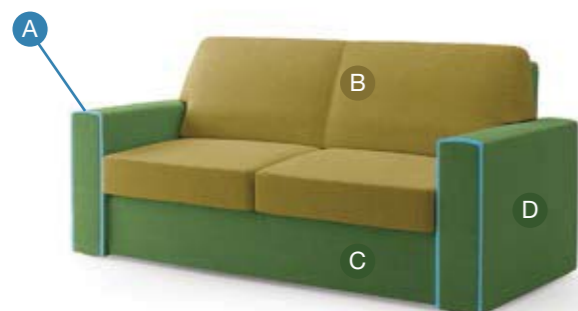

SOLUZIONE 2

Solution 2_ Solution 2_

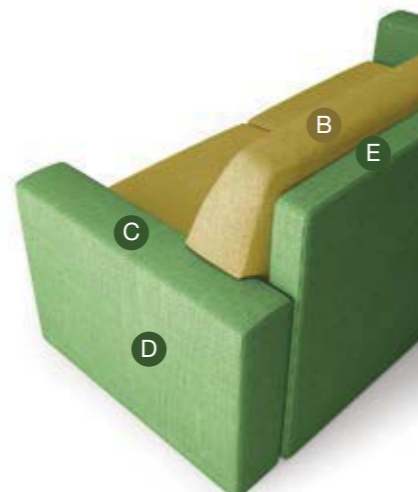
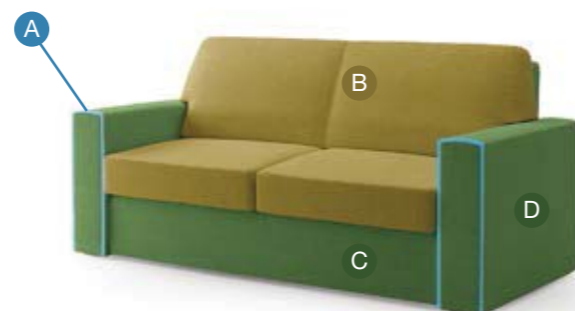

SOLUZIONE 3

Solution 3_ Solution 3_

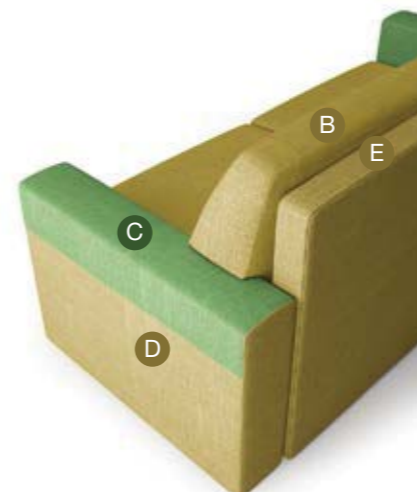
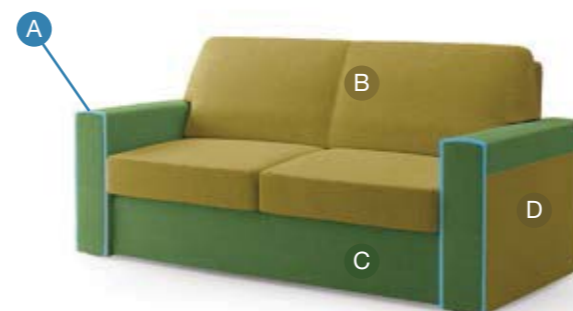

SOLUZIONE 4

Solution 4_ Solution 4_

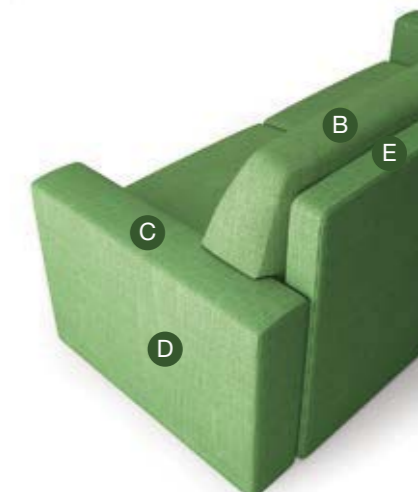
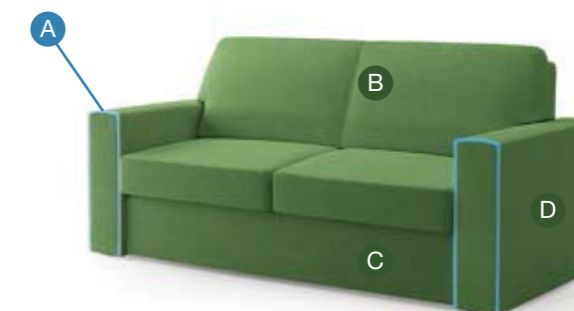

THE VARIOUS ELEMENTS THAT COMPOSE THE SOFA, SIDES AND BACK (D), SEAT AND BACK CU-
SHIONS (B), ARMRESTS AND BASE (C), HEADBOARD (E-F) AND BORDER (A), CAN BE COVERED BY
FREELY COMBINING THREE DIFFERENT COLOURS AND FABRICS, CREATING FOUR COORDINATED
SOLUTIONS.

LES DIFFÉRENTS ÉLÉMENTS QUI COMPOSENT LE CANAPÉ CONVERTIBLE, PANNEAUX LATÉRAUX ET
ARRIÈRE (D), COUSSINS D'ASSISE ET DE DOSSIER (B), ACCOUDOIRS ET BASE (C), TÊTE DE LIT (E-F)
ET BORDURES (A), PEUVENT ÊTRE REVÊTUS EN COMBINANT LIBREMENT TROIS COLORES ET TISSUS
DIFFÉRENTS, EN CRÉANT QUATRE SOLUTIONS D'ASSOCIATION.

MOSLEY

SFODERABILE AL 100%

100% removable cover
Déhoussable à 100%



COMPLETAMENTE SMONTABILE GRAZIE AL SISTEMA A BAIONETTA SEMPLICE E ROBUSTO. PRATICO PER MOVIMENTAZIONI E TRASLOCHI.

APERTURA A ROTAZIONE DELLO SCHIENALE. UN SOLO MOVIMENTO PER PASSARE DAL DIVANO AL LETTO: LO SCHIENALE RUOTA INSIEME ALLA SEDUTA SENZA RIMUOVERE I CUSCINI.

Meccanismi ad alta resistenza e servoassistiti.

1. Sistema di apertura facilitata.
2. Sistema di aggancio materasso alla rete.
3. Robusto telaio in metallo e rete elettrosaldata indeformabile.
4. Contenitore per guanciali del letto.
5. Pratica e robusta zip per le sedute. La cerniera divisibile pressofusa in nylon da 8 mm. ci permette di fissare il cuscino seduta alla struttura.
6. Seduta cinghiata opzionale

COMPLETELY DETACHABLE THANKS TO THE SIMPLE AND ROBUST BAYONET SYSTEM. PRACTICAL FOR HANDLING AND MOVING.

OPENING THROUGH ROTATION OF THE BACK JUST ONE MOVE TO SWITCH FROM THE SOFA TO THE BED: THE BACKREST ROTATES TOGETHER WITH THE SEAT WITHOUT REMOVING THE CUSHIONS.

High strength power assisted mechanisms

1. Easy opening system.
2. Mattress-support coupling system.
3. Sturdy metal frame and undeformable electro-welded support.
4. Container for storing bed pillows.
5. Practical and robust zip for the seats. The divisible 8 mm die cast nylon zip allows for securing the seat cushion to the structure.
6. Optional belted seat

ENTIÈREMENT DÉMONTABLE GRÂCE AU SYSTÈME À BAÏONETTE SIMPLE ET RÉSISTANT. PRATIQUE POUR LES DÉPLACEMENTS ET LES DÉMÉNAGEMENTS.

OUVERTURE ROTATIVE DU DOSSIER. UN SEUL MOUVEMENT POUR PASSER DU CANAPÉ AU LIT : LE DOSSIER PIVOTE AVEC L'ASSISE SANS BESOIN DE RETIRER LES COUSSINS.

Mécanismes haute résistance et assisté.

1. Système d'ouverture facile.
2. Système de fixation matelas/sommier.
3. Cadre robuste en métal et sommier électrosoudé indéformable.
4. Rangement pour oreillers.
5. Fermeture éclair pratique et robuste pour le déhoussage. La charnière de 8 mm. en fusion de nylon nous permet d'assurer les assises à la structure.
6. Assise sanglée en option



1



3-4



5



6

CLEAN UP SYSTEM

UNA NUOVA PRATICA SOLUZIONE PER LA PULIZIA

A new practical solution for cleaning
Une nouvelle solution pratique pour le nettoyage

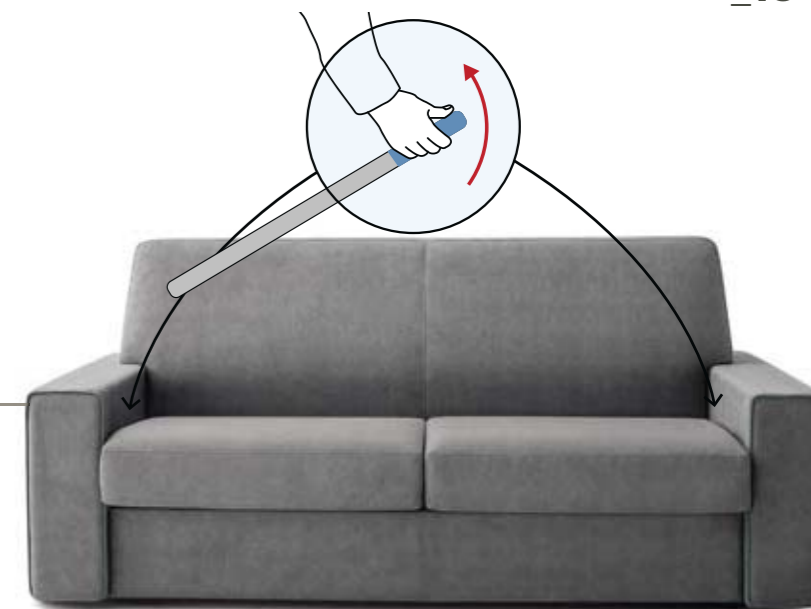

PULIRE IL PAVIMENTO SOTTO IL DIVANO NON È PIÙ UN PROBLEMA CON CLEAN UP SYSTEM, IL BREVETTO ESCLUSIVO FELIS CHE FA RISPARMIARE TEMPO E FATICA. PER SPOSTARE AVANTI E INDIETRO IL DIVANO SENZA SFORZO È SUFFICIENTE ALZARE DUE LEVE A SCOMPARSA, TRA IL BRACCIOLO E LA SEDUTA, CHE CONSENTONO DI ABBASSARE 4 ROBUSTE RUOTE ALZANDO COSÌ TUTTO IL DIVANO. FACILISSIMO QUINDI SPOSTARLO SENZA SFORZO. QUANDO TORNA AL SUO POSTO, LE LEVE SI ABBASSANO, LE RUOTE SI SOLLEVANO E SCOMPAIONO E IL DIVANO POGGIA NUOVAMENTE SUI SUOI PIEDINI. FACILE, VELOCE, PRATICO E SICURO.

CLEANING THE FLOOR UNDER THE SOFA IS NO LONGER A PROBLEM WITH THE CLEAN UP SYSTEM, THE EXCLUSIVE FELIS PATENTED SYSTEM THAT SAVES TIME AND EFFORT. TO MOVE THE SOFA BACK AND FORTH WITHOUT EFFORT, SIMPLY RAISE THE TWO LEVERS ON THE SIDES, CONCEALED BETWEEN THE ARMREST AND THE SEAT, THAT ALLOWS FOR LOWERING FOUR STURDY WHEELS, THUS RAISING THE ENTIRE SOFA OFF THE GROUND. IT CAN THEN BE EASILY MOVED WITHOUT EFFORT. WHEN THE SOFA IS RETURNED TO ITS ORIGINAL LOCATION, THE LEVERS ARE LOWERED, THE WHEELS ARE RAISED AND DISAPPEAR, AND THE SOFA RESTS ON ITS FEET AGAIN. EASY, FAST, CONVENIENT, AND SAFE.

NETTOYER LE SOL SOUS LE CANAPÉ N'EST PLUS UN PROBLÈME AVEC CLEAN UP SYSTEM, LE BREVET EXCLUSIF FELIS QUI PERMET D'ÉCONOMISER TEMPS ET EFFORT. POUR DÉPLACER LE CANAPÉ VERS L'AVANT ET VERS L'ARRIÈRE SANS EFFORT, IL SUFFIT DE SOULEVER LES DEUX LEVIERS DISSIMULÉS ENTRE L'ACCOUDOIR ET L'ASSISE, PERMETTANT D'ABAISSE 4 SOLIDES ROUES ET DE RELEVER L'INTÉGRALITÉ DU CANAPÉ. TRÈS SIMPLE À DÉPLACER SANS EFFORT. LORSQUE LE CANAPÉ REVIENT EN PLACE, LES LEVIERS S'ABAISSENT, LES ROUES SE SOULEVENT ET DISPARAISSENT PERMETTANT AU CANAPÉ DE REPOSER À NOUVEAU SUR LE SOL, SUR SES PIEDS. FACILE, RAPIDE, PRATIQUE ET SANS DANGER.

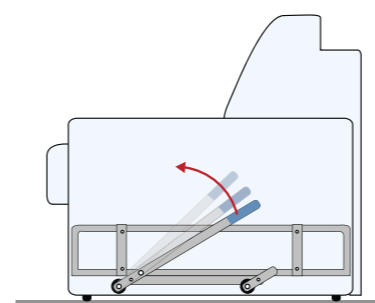

CLEAN UP SYSTEM OPTIONAL

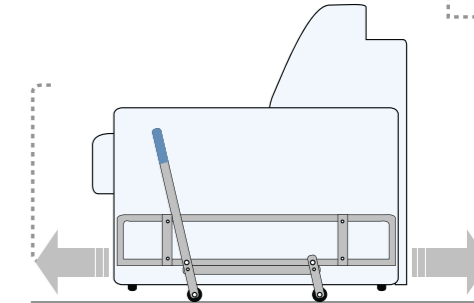
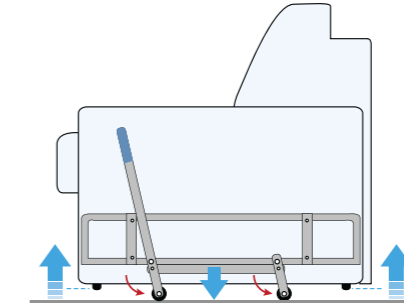

MOSLEY

IL COMFORT DI UN VERO LETTO CON 4 VARIANTI DI MATERASSO

The comfort of a real bed with 4 mattresses
Le confort d'un vrai lit avec 4 matelas



↓
16 cm
↑

**OPTIONAL
TOP QUALITY
D30**

UN PROGRAMMA ARTICOLATO COME DREAM COLLECTION PREVEDE ANCHE UNA PROPOSTA ARTICOLATA DI MATERASSI. OLTRE ALLO STANDARD IN ESPANSO LA POSSIBILITÀ OPTIONAL DI ALTRE TRE TIPOLOGIE... SFODERABILE D30, MEMORY FOAM, TOP QUALITY D30 DA H 16 CM.

AN ARTICULATED LINE SUCH AS THE DREAM COLLECTION ALSO INCLUDES A COMPLETE SELECTION OF MATTRESSES. IN ADDITION TO THE STANDARD MATTRESS IN POLYURETHANE FOAM, THREE OTHER TYPES ARE AVAILABLE... REMOVABLE, D30, MEMORY FOAM, TOP QUALITY D30 WITH H 16 CM.

UN PROGRAMME ARTICULÉ TEL QUE DREAM COLLECTION PRÉVOIT ÉGALEMENT UNE PROPOSITION ARTICULÉE DE MATELAS. OUTRE LA VERSION STANDARD EN MOUSSE, TROIS AUTRES TYPLOGIES SONT ÉGALEMENT DISPONIBLES EN OPTION... DÉHOUSSABLE D30, MEMORY FOAM, TOP QUALITY D30 DE 16 CM.

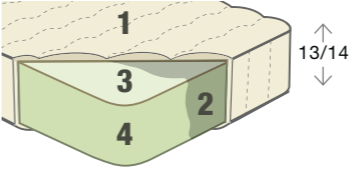
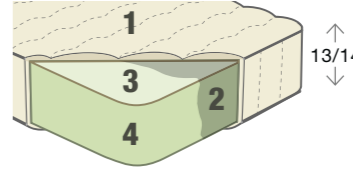
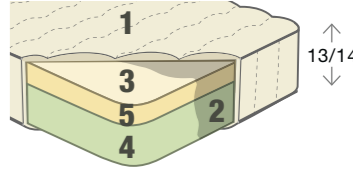
	STANDARD	OPTIONAL	OPTIONAL
	MATERASSO ESPANSO D.25 D.25 FOAM MATTRESS MATELAS EN MOUSSE D.25 	MATERASSO COMFORT D.30 D.30 FOAM MATTRESS MATELAS COMFORT D.30 	MATERASSO MEMORY FOAM MEMORY FOAM MATTRESS MATELAS MEMORY FOAM 
CARATTERISTICA CHARACTERISTICS CARACTÉRISTIQUE	Non sfoderabile / Non-removable / Non déhoussable	Sfoderabile con tessuto stretch / Stretch fabric removable cover / Déhoussable avec tissu stretch	Sfoderabile con tessuto stretch / Stretch fabric removable cover / Déhoussable avec tissu stretch
altezza / height / hauteur	13/14 cm	13/14 cm	13/14 cm
lunghezza / length / longueur	da 197 cm	da 197 cm	da 197 cm
larghezza / width / largeur	da 70 a 160 cm	da 70 a 160 cm	da 70 a 160 cm
1 Tessuto rivestimento Fabric / Tissu de revêtement	trapuntato su due lati - poliester stretch quilted on both sides - stretch polyester matelassé sur les deux faces polyester extensible	trapuntato su due lati - poliester stretch quilted on both sides - stretch polyester matelassé sur les deux faces polyester extensible	trapuntato su due lati / poliester stretch quilted on both sides / stretch polyester matelassé sur les deux faces polyester extensible
2 Termolegato 100% poliester / Thermobonded 100% polyester / Collé à chaud 100% polyester	gr. m ² 350	gr. m ² 350	gr. m ² 350
3 TNT bianco 100% poliester / TNT white 100% polyester / TNT blanc 100% polyester	gr. m ² 15	gr. m ² 15	gr. m ² 15
4 Espanso di polieter / Polyether foam / Mousse de polyester	D25	D30	D28
5 Memory Foam			D45

OPTIONAL

MATERASSO TOP QUALITY D30 H 16 CM
TOP QUALITY D30 MATTRESS H 16 CM
MATELAS TOP QUALITY D30 H 16 CM

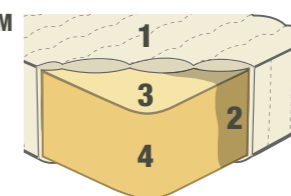

Non sfoderabile.
Materasso dotato di ganci amovibili per fissaggio rete.
Non-removable.
Mattress with removable hooks for securing the support.
Non déhoussable.
Matelas avec crochets amovibles pour la fixation au sommier.

altezza / height / hauteur	16 cm
lunghezza / length / longueur	da 197 cm
larghezza / width / largeur	da 70 a 160 cm
1 Tessuto rivestimento Fabric / Tissu de revêtement	Stretch sagomato e cucito / Poliester 100% antiacaro da 250 gr Shaped and sewn stretch / 100% anti-mite polyester 250 gr Stretch moulé et cousu / Polyester 100% anti-acarien de 250 g
2 Falda in poliester 100% 100% polyester layer Couche 100% polyester	gr. m ² 250
3 TNT bianco 100% poliester / TNT white 100% polyester / TNT blanc 100% polyester	gr. m ² 15
resistenza alla compressione / compressive strength / résistance à la compression 40% KPA ->	3.8
4 Espanso di polieter / Polyether foam / Mousse de polyester	D30
resistenza alla compressione / compressive strength / résistance à la compression 40% KPA ->	1.200

RETE

Meccanica con tubolare d'acciaio a sezione quadrata verniciata con polveri epossidiche e dotata di meccanismo testato dal nostro ufficio tecnico per oltre 2.000 cicli di apertura. Il piano dormita supporta il peso di due persone adulte di peso medio senza deformarsi.

TELAIO

Realizzato con masselli di abete in vari spessori, parti di tamponamento in fibra di legno e/o compensato, fianchi in agglomerato di legno da 18 mm. Fibra grezza e/o agglomerato di legno a bassa emissione di formaldeide, il tutto rivestito con vellutino 100% poliammide termoaccoppiato ad espanso di poliestere e/o ovatta di poliestere 100% da 200gr.

IMBOTTITURA

Seduta in espanso indeformabile di poliuretano sagomato in D28 con portanza 3,6. Rivestimento cuscino seduta sagomato ed incollato, composto da resinato di poliestere 100% da 200gr. Schiena in espanso indeformabile di poliuretano D18 con portanza 1,6. Braccioli tampone in espanso indeformabile sagomato in poliuretano D40 con portanza 8,0.

SUPPORT SYSTEM

Mechanical system featuring a steel square sectioned tubular frame, coated in epoxy powder and equipped with a mechanism tested by our technical office for over 2,000 opening cycles. The sleeping surface can easily support the weight of two adults of average weight, without being deformed.

FRAME

Made with planks of solid spruce wood in various thicknesses, frame panels in wood fibre and/or plywood, sides in 18 mm chipboard. Crude fibre and/or low formaldehyde emission chipboard, all covered with 100% polyamide velvet thermo-coupled to polyester foam and/or wadding in 100% 200gr polyester.

UPHOLSTERY

Seat in shaped non-deformable polyether foam in D28 nylon with 3.6 carrying capacity. Seat cushion covering, shaped and glued, consisting of 100% 200gr polyester resin. Back in non-deformable D18 polyether foam with 1.6 carrying capacity. Armrest pads in non-deformable D40 polyether foam with 8.0 carrying capacity.

SOMMIER

Système mécanique avec tube d'acier à section carrée peint avec poudre époxy et équipé d'un mécanisme testé par notre service technique sur plus de 2.000 cycles d'ouverture. Le plan de couchage peut supporter le poids de deux adultes de poids moyen sans se déformer.

CADRE

Fabriqué en bois massif de sapin de différentes épaisseurs, pièces de remplissage en fibre de bois et/ou contreplaqué, panneaux latéraux en bois aggloméré de 18 mm. Fibres brutes et/ou bois aggloméré à faible émission de formaldéhydes, le tout revêtu de velours 100% polyamide relié à chaud à de la mousse de polyester et/ou ouate 100% polyester de 200 g.

REMBOURRAGE

Assise en mousse indéformable de polyuretano façonnée en D28 avec force portante de 3,6. Revêtement du coussin de l'assise formé et collé, constitué de résines 100% polyester de 200 g. Dossier en mousse indéformable de polyuretano D18 avec force portante de 1,6. Accoudoir tampon en mousse indéformable moulé en polyester D40 avec force portante de 8,0.

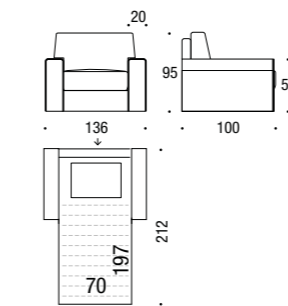

ART. 01
POLTRONA
CHAIR
FAUTEUIL

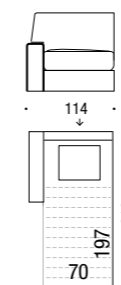

ART. 1D-1S
LATERALE 1 POSTO DX-SX
RH-LH 1-SEATER SIDE
ELEMENT
CANAPÉ BÂTARD 1 PLACE
D-G

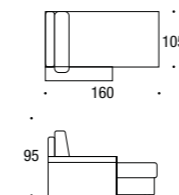

CD-CS
CHAISE LONGUE DX-SX
RH-LH CHAISE LONGUE
MÉRIDIENNE D-G

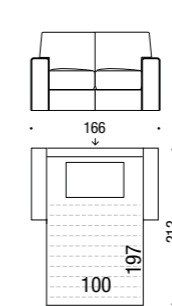

ART. 02
DIVANO 2 POSTI
2-SEATER SOFA
CANAPÉ 2 PLACES

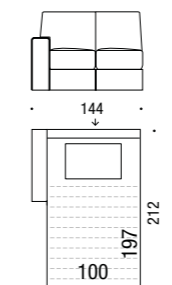

ART. 2D-2S
LATERALE 2 POSTI DX-SX
RH-LH 2-SEATER SIDE
ELEMENT
CANAPÉ BÂTARD 2 PLACES
D-G

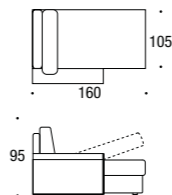

ART. XD-XS
CHAISE LONGUE DX-SX
CON CONTENITORE
RH-LH CHAISE LONGUE WITH
STORAGE
MÉRIDIENNE D-G AVEC
RANGEMENT D-G

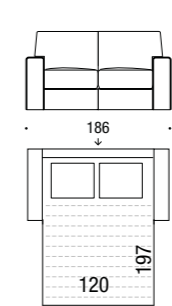

ART. 20
DIVANO 2 POSTI GRANDE
2-SEATER LARGE SOFA
CANAPÉ 2 GRANDES PLACES

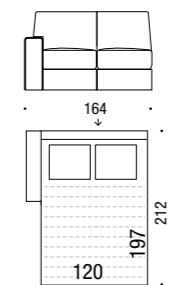

ART. GD-GS
LATERALE 2 POSTI GRANDE
DX-SX
RH-LH 2-SEATER LARGE SIDE
ELEMENT
CANAPÉ BÂTARD 2 GRANDES
PLACES D-G

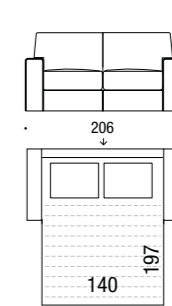

ART. 03
DIVANO 3 POSTI
3-SEATER SOFA
CANAPÉ 3 PLACES

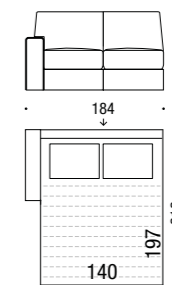

ART. 3D-3S
LATERALE 3 POSTI DX-SX
RH-LH 3-SEATER SIDE
ELEMENT
CANAPÉ BÂTARD 3 PLACES
D-G

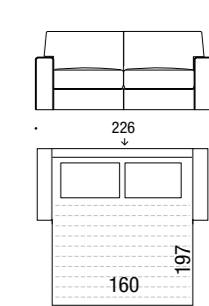

ART. 07
DIVANO 3 POSTI MAXI
MAXI 3-SEATER SOFA
CANAPÉ 3 PLACES MAXI

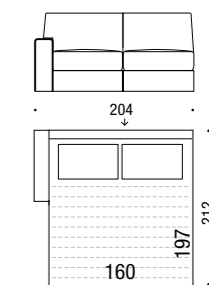

ART. 7D-7S
LATERALE 3 POSTI MAXI
DX-SX
RH-LH MAXI 3-SEATER SIDE
ELEMENT
CANAPÉ BÂTARD 3 MAXI
PLACES D-G