

Spencer

Completamente sfoderabile
Totally removable cover
Complètement déhoussable



Caratteristiche tecniche

Masselli in legno di abete e/o sciolati in multistrato di legno di pioppo.
Pannelli da 18/25 mm in particelle di legno in classe E1 a bassa emissione di formaldeide e fibra di legno naturale.
Espansi di poliuretano indeformabile a portanza differenziata, densità da 18 kg/mc a 40 kg/mc.
Primo rivestimento in espanso di poliestere accoppiato a caldo a vellutino aggrappante in poliestere e/o ovatta di poliestere al 100% da 200gr.
Pannelli fondo contenitore da 12-14 mm in particelle di legno di pioppo in classe E1.

Technical characteristics

Forgings fir wood, and/or boxed in poplar plywood.
Panels 18/25 mm in poplar wood particles class E1 low formaldehyde emission and natural wood fiber.
Polyurethane foam, crushproof, of different capacity, density from 18 kg/mc to 40 kg/mc.
First coating hot bonded polyester foam, velvet adhesion in polyester and/or 100% polyester wool, 200gr.
Container bottom panels 12-14 mm in poplar wood particles class E1.

Caractéristiques techniques

Tige en pin et/ou boitiers en multicouche en bois de peuplier.
Panneaux de 18/25 mm en particules de bois de peuplier classe E1 à faible émission de formaldéhyde et fibre de bois naturelle.
Polyuréthane expansé indéformable à portée différenciée, densité de 18kg/m2 à 40kg/m2.
Premier revêtement en polyester expansé accouplé à chaud à un velours accrochant en polyester et/ou ouate de polyester à 100% de 200g.
Panneaux de fond coffre rangement de 12-14mm en particules de bois de peuplier classe E1.



Optional

Rete | Support | Sommier

Pag. 108

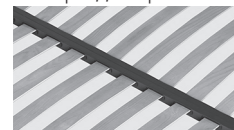

Armony
(Standard)

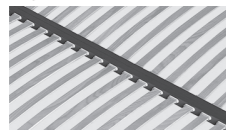

Thai
46 doghe
46 slats
46 attes

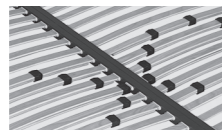

Energy - Non applicabile a rete da 120 cm
Not applicable to 120 cm support
Non applicable au sommier de 120 cm

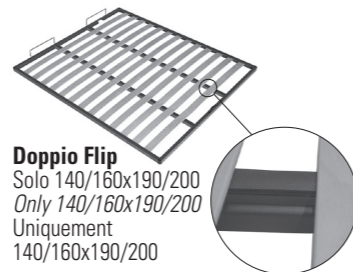

Doppio Flip
Solo 140/160x190/200
Only 140/160x190/200
Uniquement 140/160x190/200

Pag. 111

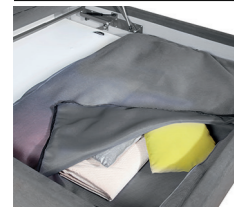

Sacco contenitore multiuso
Multipurpose storage bag
Sac coffe re de rangement multi usage

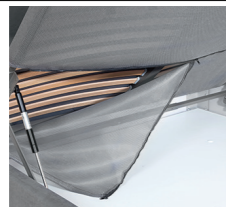

Tessuto copirete traspirante antipolvere
Support cover fabric breathable and dustproof
Tissu couvre-sommier transpirant anti-poussière

Pag. 114



Clean Up System

Pag. 115



Regolatore altezza rete solo per reti in appoggio
Support height adjuster Only for resting frames
Réglage hauteur sommier uniquement pour sommiers à poser

Elemento testiera mobile e removibile | Elemento testiera mobile e removibile | Elemento testiera mobile e removibile



Ring Smart

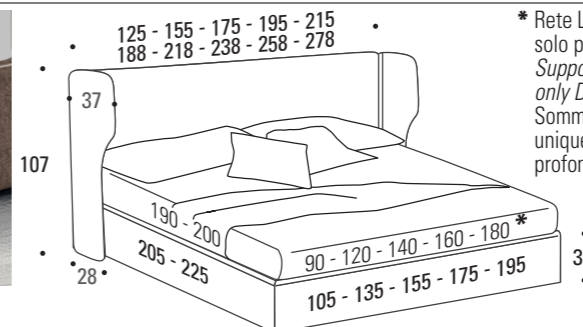

* Rete L. 180 cm solo profondità 200 cm
Support W. 180 cm only D.200 cm
Sommier L. 180 cm uniquement en profondeur 200 cm

Optional

Meccanica | Mechanism | Mécanique

Pag. 110

Dynamic

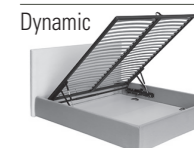

Maverick



Standard Basic H 3

Pag. 107

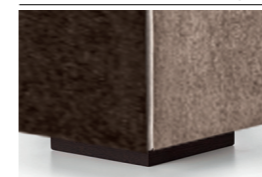

wengé | wengé | wengé

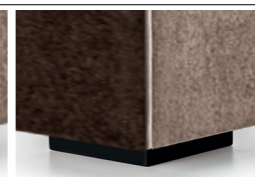

nero | black | noir

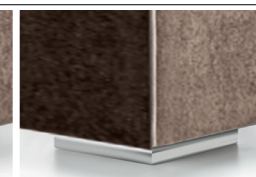

argento | silver | argent

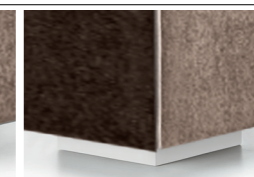

bianco | white | blanc

Optional Lux H 3

Pag. 107



wengé | wengé | wengé



nero | black | noir



cromo | chrome | chrome



bianco | white | blanc

Ring York

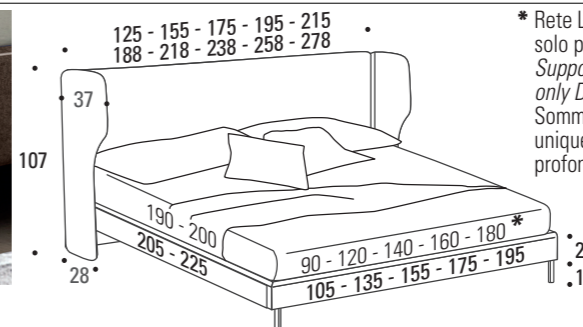

* Rete L. 180 cm solo profondità 200 cm
Support W. 180 cm only D.200 cm
Sommier L. 180 cm uniquement en profondeur 200 cm

Optional

Meccanica | Mechanism | Mécanique

Pag. 110

Dynamic



Piede TWINNY a doppio stiletto H. 13 | Double stiletto TWINNY foot H. 13 | Pied TWINNY double talon H. 13

Pag. 107



Cromo lucido
Shining chrome
Chrome brillant



Carbon look lucido
Shining carbon look
Carbon look brillant



Nero opaco
Mat black
Noir mat

Piede BAOBAB in legno H.13 | BAOBAB wooden feet H. 13 | Pied BAOBAB en bois H.13

Pag. 107



Rovere Londra
Dak "Londra"
Chene "Londra"



Rovere tabacco
Dak "tabacco"
Chene "tabacco"

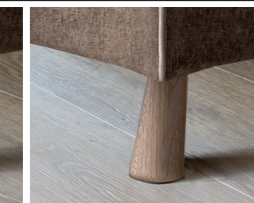

Rovere naturale
Dak "naturale"
Chene "naturale"