

PIANCA



LINK Wardrobe design R&S PIANCA

The natural warmth of wood, the variety of lacquered finishes, the beauty of high gloss are all quality features of the Link doors. The colours and finish options available allow for the creation of compositions marked by classic elegance or original modernity.

Tidy wardrobe interiors are guaranteed by an extensive array of internal fittings, functional solutions with painstaking care for details. The shelves and cubbies stand out for their thickness, while the drawer units can be made with wooden or glass fronts. The choice of fittings is available in the range of lacquered and wood finishes and three finishes for the wardrobe structure: bianco talco, borgogna and the new perlage finishes.

PIANCA

WING DOOR AND FOLDING DOOR DRESSING CLOSET

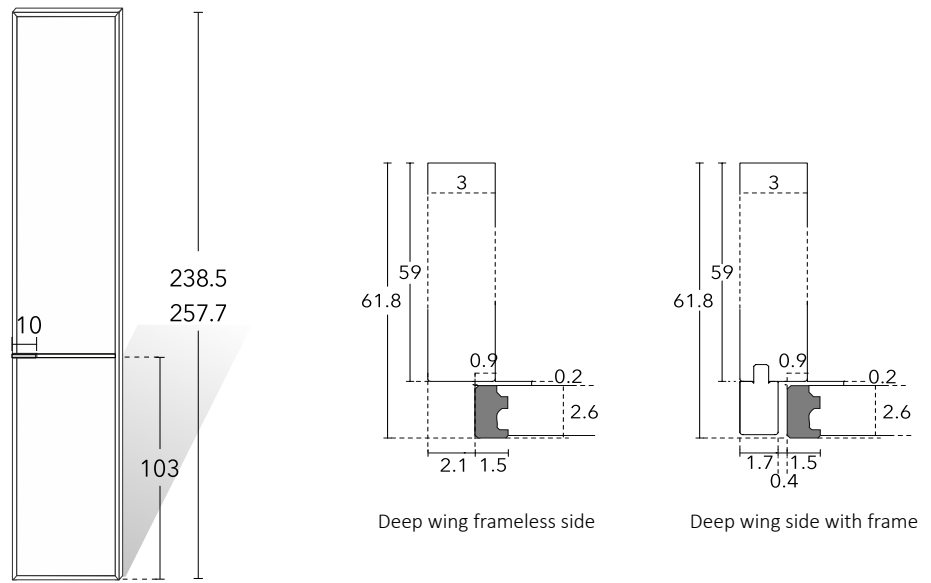

DOOR DIMENSION

W 50 | H 238.5- 257.7 cm

W 60 | H 238.5- 257.7 cm

W 70 | H 238.5- 257.7 cm

CHARACTERISTICS

Door made of engineered wood panels with an MDF frame with a eco veneer or an anodized aluminum frame. Panels cannot be disassembled.

Frame Finishes in aluminum; matt laquered in the colors of the glasses; wood: Borgogna, Canaletto, Rovere Grigio.

Panels Finishes Matt or high gloss laquered; Matt or glossy laquered glass; Silver and smokey mirror; wood: Borgogna, Canaletto, Rovere Grigio.

Door interior with laquered panels: same finish as the exterior of the door; with glass or mirror panels: same finish as the internal structure of the closet.

Handle Horizontal.

FOLDING DOOR DRESSING CLOSET

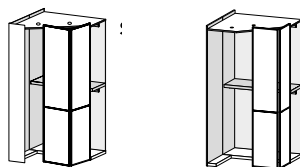

W 131 | 134 cm

W 131 | 131 cm

Height 238.5 | 257.7 cm available in custom size with additional charge

PIANCA

WING DOOR MODULES D 60 cm



W 47.8 cm
W 57.8 cm
W 67.8 cm

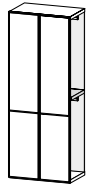

W 97.8 cm

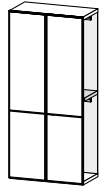

W 117.8 cm

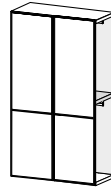

W 137.8 cm

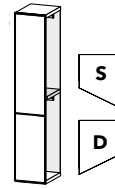

TERMINAL
W 46.1 cm

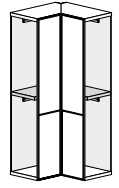

CORNER
W 110.7cm

Height 238.5 | 257.7 cm available in custom size with additional charge

COMPOSITIONS



• 50 • 100 •

W 153.8 cm



• 60 • 120 •

W 183.8 cm



• 100 • 100 •

W 203.8 cm

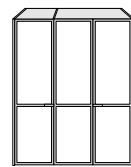

• 70 • 140 •

W 213.8 cm

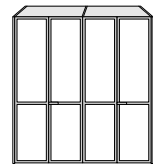

• 120 • 120 •

W 243.8 cm



• 100 • 50 • 100 •

W 253.8 cm

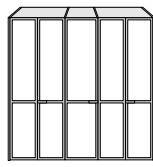

• 100 • 60 • 100 •

W 263.8 cm

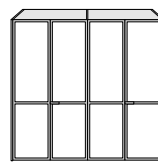

• 140 • 140 •

W 283.8 cm

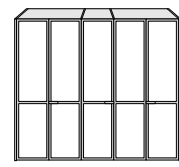

• 120 • 60 • 120 •

W 303.8 cm

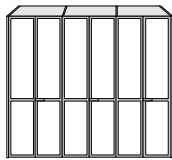

• 100 • 100 • 100 •

W 303.8 cm

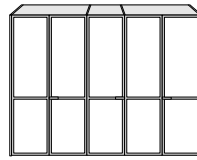

• 140 • 70 • 140 •

W 353.8 cm

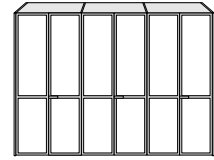

• 120 • 120 • 120 •

W 363.8 cm

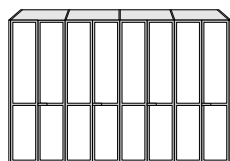

• 100 • 100 • 100 • 100 •

W 403.8 cm

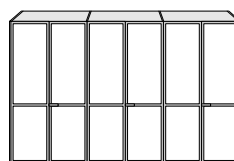

• 140 • 140 • 140 •

W 423.8 cm

PIANCA

SLIDING DOOR

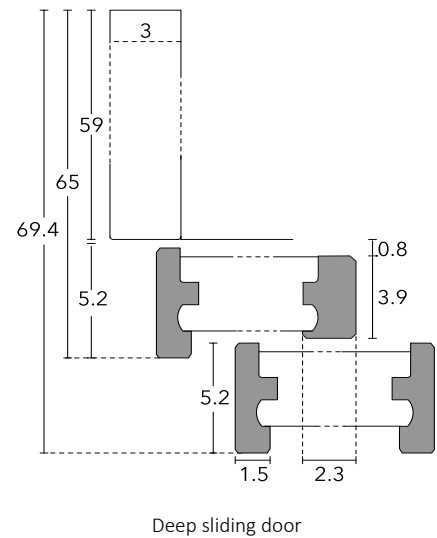
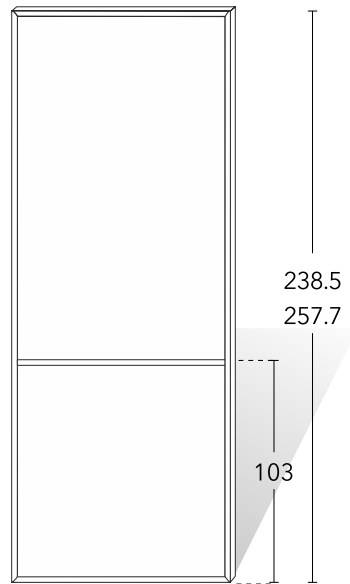

DOOR DIMENSIONS

W 70 | H 238.5- 257.7 cm

W 100 | H 238.5- 257.7 cm

W 120 | H 238.5- 257.7 cm

CHARACTERISTICS

Sliding Door made of industrial honeycomb panels with a eco veneered MDF or anodized aluminum frame. Panels cannot be disassembled.

Frame Finishes in aluminum; Matt laquered in the colors of the glasses; Wood: Borgogna, Canaletto, Rovere Grigio.

Panels Finishes Matt or high gloss laquered; Matt or glossy laquered glass; Silver and smokey mirror; wood: Borgogna, Canaletto, Rovere Grigio.

Door interior with laquered panels: eco veneer; with glass or mirror panels: eco veneer.

Handle for sliding door vertical, single for internal sliding door, double for external sliding door.

PIANCA

SLIDING DOOR MODULES D 60 cm



W 67.8 cm



W 97.8 cm



W 117.8 cm

Height 238.5 | 257.7 cm available in custom size with additional charge

COMPOSITIONS

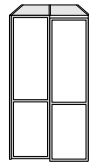

• 70 • 70 •

W 143.8 cm



• 100 • 100 •

W 203.8 cm

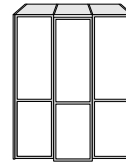

• 70 • 70 • 70 •

W 213.8 cm

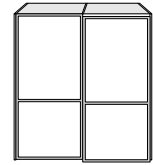

• 120 • 120 •

W 243.8 cm

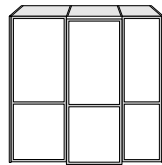

• 100 • 100 • 70 •

W 273.8 cm

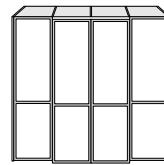

• 70 • 70 • 70 • 70 •

W 283.8 cm

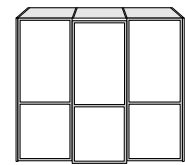

• 100 • 100 • 100 •

W 303.8 cm

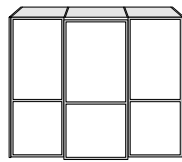

• 100 • 120 • 100 •

W 323.8 cm

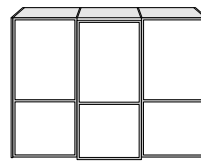

• 120 • 120 • 120 •

W 363.8 cm

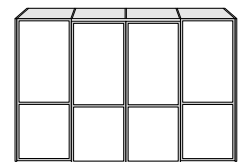

• 100 • 100 • 100 • 100 •

W 403.8 cm

MADE TO MEASURE SOLUTIONS

With Pianca you choose to enrich your wardrobe's uses and functionality: a vast array of uniquely modular additions such as: terminal elements, bridges, dressing closet, fillers. Just add the option to request tailor-made solutions for your structure to adapt and fit right into any space inside your home.*

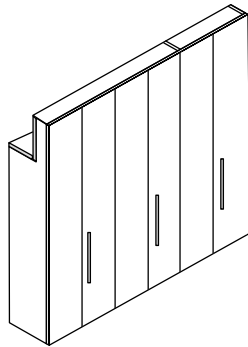

DEPTH REDUCTION

Possible reductions on wing, sliding, bridge solutions but not on flush sliding modules.

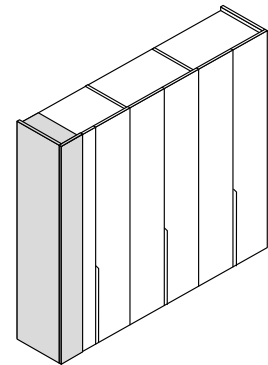

WIDTH REDUCTION

It is possible to reduce in width wing modules, sliding modules, bridge solutions and closets.

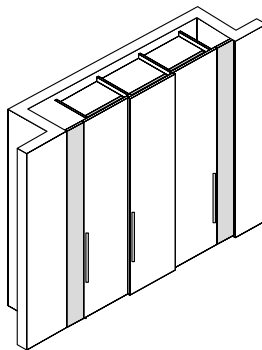

FILLERS

Available for wing and sliding modules, both for superior and lateral fillers. The fillers are available for fixing it flush with the door or with the side.

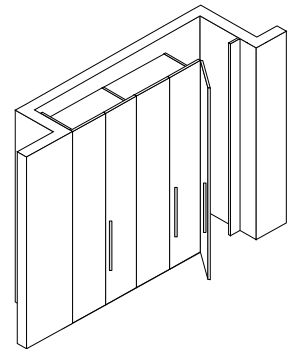

FILLER DOORS

Lateral filler with wing opening made-to-measure in width from 15 to 70 cm equipped with wall mounted stopper and 180° hinges. It is not possible to use the Y handle or the push pull opening.

* No customization is possible for Cornice and Link doors with aluminium frame, Print, Crea, Riflesso, Vela, Vitrum and Window doors; flush-sliding; wing door terminal modules; dressing closet. Drawers as well as glass, metal and pull-out accessories cannot be custom sized.

PIANCA

INTERIORS

Tidy wardrobe interiors are guaranteed by an extensive array of internal fittings, functional solutions with painstaking care for details. The shelves and cubbies stand out for their thickness, while the drawer units can be made with wooden or glass fronts.

The choice of fittings is available in the range of lacquered and wood finishes and three finishes for the wardrobe structure: Bianco talco, Perlage terra, Perlage conchiglia and Borgogna.

Interior configurations

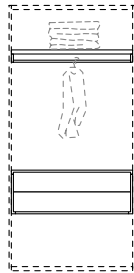

AM PROPOSE:
1 hanging rod
1 wooden shelf
1 hanging drawer unit

DIMENSIONS
W 97.8 | 117.8 | 137.8 | 147.8

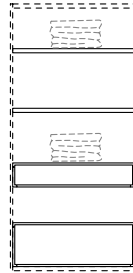

AN PROPOSE:
2 wooden shelves
1 hanging drawer unit
1 floor-sitting drawer unit

DIMENSIONS
W 97.8 | 117.8 | 137.8 | 147.8

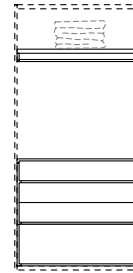

AP PROPOSE:
1 hanging rod
1 wooden shelf
1 floor-sitting drawer unit

DIMENSIONS
W 97.8 | 117.8 | 137.8 | 147.8

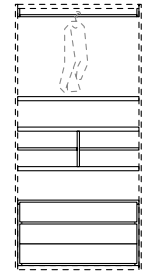

AQ PROPOSE:
1 hanging rod
1 wooden shelf
1 floor-sitting drawer unit
1 wooden cubby

DIMENSIONS
W 97.8 | 117.8



AE PROPOSE:
2 hanging rods
4 wooden shelves
1 internal partition

DIMENSIONS
W 97.8 | 117.8 | 137.8 | 147.8 cm

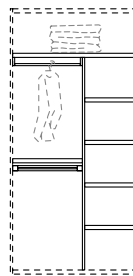

AL PROPOSE:
1 hanging rod
6 wooden shelves
1 internal partition
1 pull-out trouser rack

DIMENSIONS
W 117.8 | 137.8 | 147.8 cm

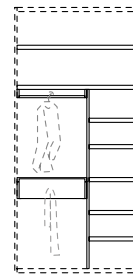

AC PROPOSE:
1 hanging rod
7 wooden shelves
1 hanging drawer unit
1 pull-out trouser rack
1 internal partition

DIMENSIONS
W 117.8 | 137.8 | 147.8 cm

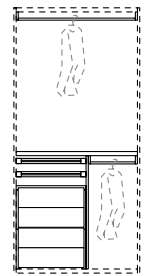

AD PROPOSE:
2 hanging rods
1 wooden shelf
2 pull-out wooden shelves
1 floor-sitting drawer unit
1 internal partition

DIMENSIONS
W 117.8 | 137.8 | 147.8 cm

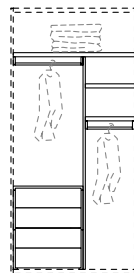

AK PROPOSE:
2 hanging rods
3 wooden shelves
1 floor-sitting drawer unit
1 internal partition

DIMENSIONS
W 97.8 | 117.8 | 137.8 | 147.8

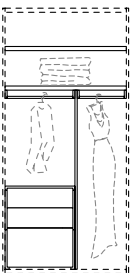

AA PROPOSE:
2 hanging rods
2 wooden shelves
1 floor-sitting drawer unit
1 internal partition

DIMENSIONS
W 97.8 | 117.8 | 137.8 | 147.8

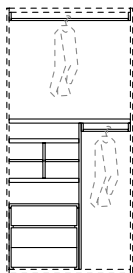

AF PROPOSE:
2 hanging rods
1 wooden shelf
1 floor-sitting drawer unit
1 wooden cubby
1 internal partition

DIMENSIONS
W 117.8 | 137.8 | 147.8 cm

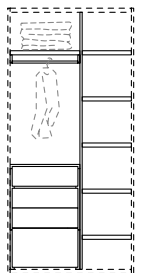

AH PROPOSE:
1 hanging rod
6 wooden shelves
1 floor-sitting drawer unit
1 internal partition

DIMENSIONS
W 117.8 | 137.8 | 147.8 cm

PIANCA

INTERNAL ACCESSORIES



PULL-OUT SHELF
In aluminium with wooden or glass shelf and front



PULL-OUT
aluminium tray with front



PULL-OUT HAMPER
With aluminium support and front



PULL-OUT BELT/ TIE RACK
To be applied on the closet sides



BASIC PULL-OUT TROUSER RACK



PULL-OUT ALLUMINIUM TROUSER RACK
Trouser rack with front



PULL-OUT DOUBLE SHOE RACK



PULL-OUT SHOE RACK



FIXED SHOE RACK



PULL-DOWN ROD
Manual or electrical



PULL-OUT ADJUSTABLE MIRROR
For unit with sliding doors or open closets



SENSOR-ACTIVATED
Recessed led lights for tops and shelves

PIANCA

ACCESSORIES

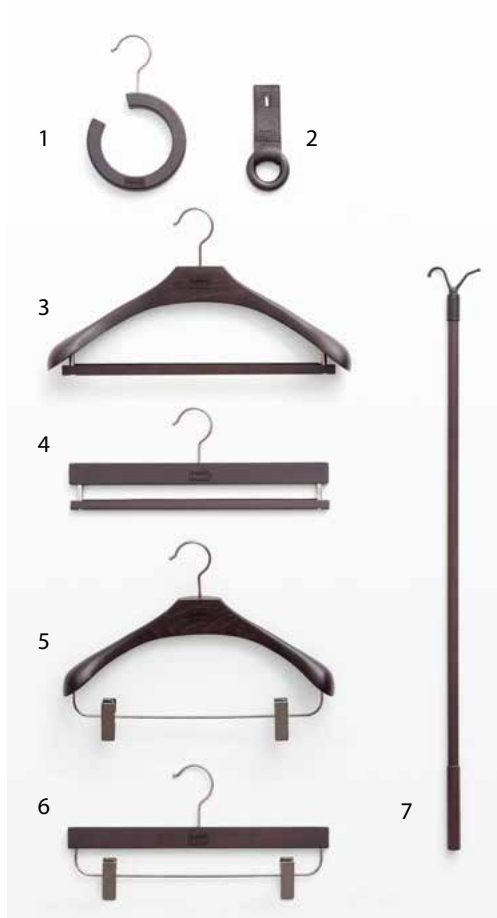

1. Scarves shawls and handbags ring hanger
2. Ties and belts ring hanger
3. Jacket + trouser hanger
4. Trousers hanger
5. Jacket + skirt hanger
6. Skirt hanger
7. Hooked rod

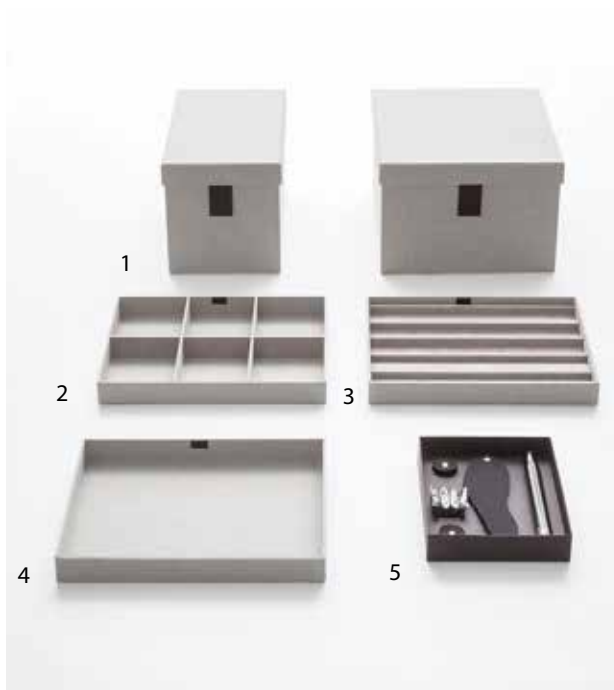

1. Boxed covered with light grey fabric
2. Tray with light grey fabric lining and cubbies for ties and belts in microfiber
3. Tray with light grey fabric lining and jewelry organizer in microfiber
4. Tray with light grey fabric lining
5. Scents and diffusers set