

COMFORT

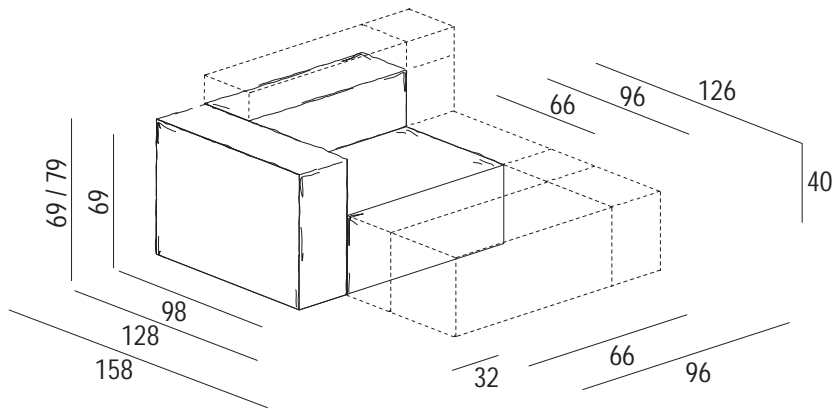



- IT** **STRUTTURA:** costruita in abete massello e rivestita in poliuretano espanso. Parti secondarie e non strutturali in pannelli di fibra di legno.
SEDUTE: imbottite in poliuretano espanso a densità differenziata e rivestite con un trapuntino in piuma (100%).
SCHIENALI: imbottiti in poliuretano espanso con tampone di poliestere e rivestiti con un trapuntino in piuma (100%). Altezza standard 69 cm come il bracciolo; possibilità di avere lo schienale più alto 79 cm specificandolo in conferma d'ordine.
BRACCIOLI: imbottiti in poliuretano espanso con tampone di poliestere e rivestiti con un trapuntino in piuma (100%).
PIEDINI: In plastica, finitura nera opaca, non a vista.
SFODERABILITÀ: totalmente sfoderabile in tessuto, non sfoderabile nella versione pelle.
- UK** **STRUCTURE:** made of solid spruce and coated with expanded polyurethane. Secondary and non-structural parts in fibreboard panels.
SEATS: padded with differed density polyurethane foam and externally coated with a 100% goose feather quilt.
BACKS: filled with polyurethane foam with polyester fibre pad and externally coated with a 100% goose feather quilt. Standard height 69 cm as per armrests; possibility of ordering a higher back (79 cm), to be specified in the order confirmation.
ARMRESTS: filled with polyurethane foam with polyester fibre pad and externally coated with a 100% goose feather quilt.
FEET: In plastic, matt black finish. Not visible.
REMOVABLE COVERS: totally removable for fabrics, non removable for the leather version.

COMFORT

* tessuto tinta unita h. 1,4 mt

* plain colour fabric h. 1,4 mt

codice

code

vol. m³

peso | weight kg

* ml occorrenti

* lm employed

SX

LH

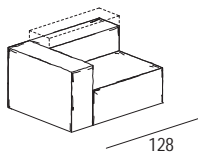

LATERALE GRANDE

BIG SIDE ELEMENT

06035LGR

0,87

45

6

SX

LH

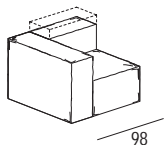

LATERALE PICCOLO

SMALL SIDE ELEMENT

06035LPI

0,66

39

5,5

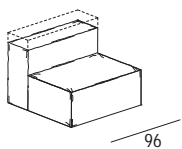

CENTRALE GRANDE

BIG CENTRAL ELEMENT

06035CGR

0,65

39

4,5

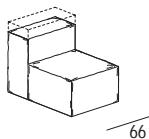

CENTRALE PICCOLO

SMALL CENTRAL ELEMENT

06035CPI

0,68

32

4

SX

LH

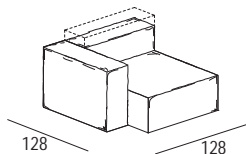

LATERALE GRANDE "MAXI"

"MAXI" SIDE ELEMENT W.128

06035LGR30

1,14

51

7

SX

LH

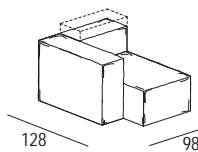

LATERALE PICCOLO "MAXI"

"MAXI" SIDE ELEMENT W.98

06035LPI30

0,87

45

6

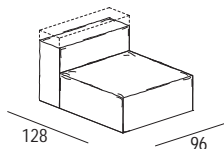

CENTRALE GRANDE "MAXI"

"MAXI" CENTRAL ELEMENT W.128

06035CGR30

0,85

45

5

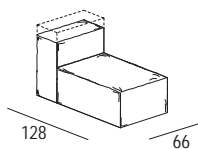

CENTRALE PICCOLO "MAXI"

"MAXI" CENTRAL ELEMENT W.98

06035CPI30

0,58

37

4,5

COMFORT

* tessuto tinta unita h. 1,4 mt

* plain colour fabric h. 1,4 mt

codice

code

vol. m³

peso | weight kg

* ml occorrenti

* lm employed

SX

LH

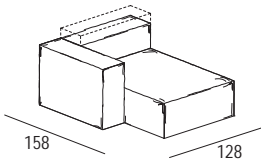

ISOLA

SECTIONAL ELEMENT

0603507

1,40

57

7,5

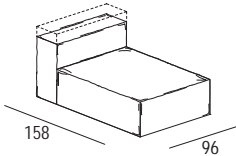

ISOLA CENTRALE

CENTRAL SECTIONAL ELEMENT

06035CI

1,04

55

6

SX

LH

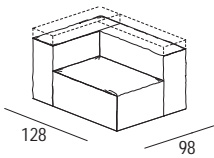

ANGOLO GRANDE

BIG CORNER

0603512L

0,86

50

6,5

SX

LH

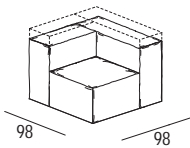

ANGOLO

CORNER

0603512C

0,66

39

6

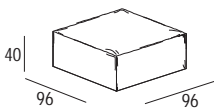

POUF QUADRATO

SQUARE POUF

0603500

0,37

21

3

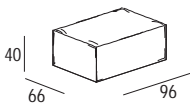

POUF RETTANGOLARE

RECTANGULAR POUF

0603599

0,25

18

2,5

OPTIONAL

Cuscino | Cushion
65 x 65

06CUSC3

0,004

0,3

0,65

Cuscino | Cushion
45 x 45

06CUSC1

0,003

0,3

0,55



COMFORT

* tessuto tinta unita h. 1,4 mt

* plain colour fabric h. 1,4 mt

codice

code

vol. m³

peso | weight kg

* ml occorrenti

* lm employed

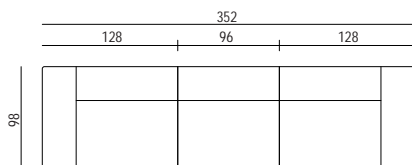

- LATERALE GRANDE SX
- CENTRALE GRANDE
- LATERALE GRANDE DX

- BIG SIDE ELEMENT - LH
- BIG CENTRAL ELEMENT
- BIG SIDE ELEMENT - RH

COMFORT 1

2,39

129

16,5

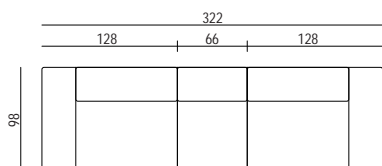

- LATERALE GRANDE SX
- CENTRALE PICCOLO
- LATERALE GRANDE DX

- BIG SIDE ELEMENT - LH
- SMALL CENTRAL ELEMENT
- BIG SIDE ELEMENT - RH

COMFORT 2

2,18

122

16

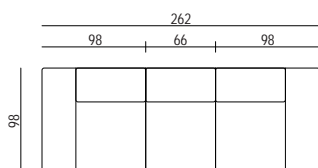

- LATERALE PICCOLO SX
- CENTRALE PICCOLO
- LATERALE PICCOLO DX

- SMALL SIDE ELEMENT - LH
- SMALL CENTRAL ELEMENT
- SMALL SIDE ELEMENT - RH

COMFORT 3

1,76

110

15

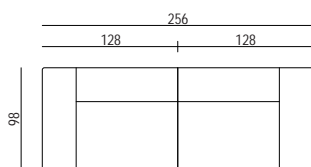

- LATERALE GRANDE SX
- LATERALE GRANDE DX

- BIG SIDE ELEMENT - LH
- BIG SIDE ELEMENT - RH

COMFORT 4

1,74

90

12

COMFORT

* tessuto tinta unita h. 1,4 mt

* plain colour fabric h. 1,4 mt

codice

code

vol. m³

peso | weight kg

* ml occorrenti

* lm employed

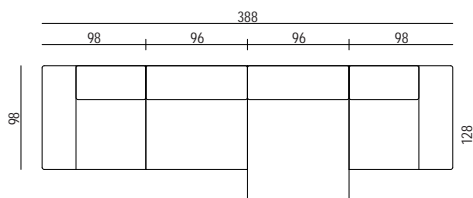

- LATERALE PICCOLO SX
- CENTRALE GRANDE
- CENTRALE GRANDE "MAXI"
- LATERALE PICCOLO DX
- SMALL SIDE ELEMENT - LH
- BIG CENTRAL ELEMENT
- "MAXI" CENTRAL ELEMENT W.128
- SMALL SIDE ELEMENT - RH

COMFORT 5

2,82

162

20,5

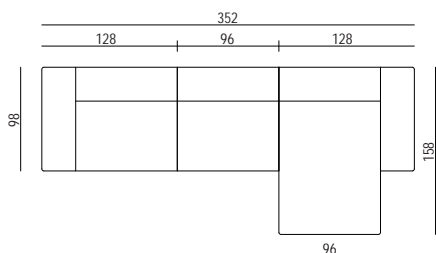

- LATERALE GRANDE SX
- CENTRALE GRANDE
- ISOLA DX

- BIG SIDE ELEMENT - LH
- BIG CENTRAL ELEMENT
- SECTIONAL ELEMENT - RH

COMFORT 6

2,92

141

18

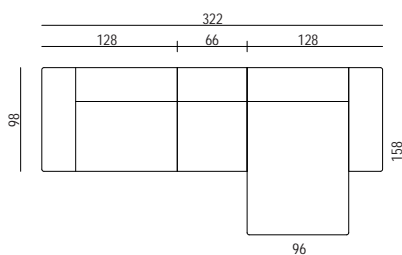

- LATERALE GRANDE SX
- CENTRALE PICCOLO
- ISOLA DX

- BIG SIDE ELEMENT - LH
- SMALL CENTRAL ELEMENT
- SECTIONAL ELEMENT - RH

COMFORT 7

2,71

134

17,5

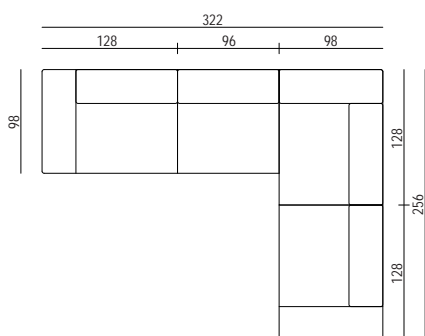

- LATERALE GRANDE SX
- CENTRALE GRANDE
- ANGOLO GRANDE
- LATERALE GRANDE DX

- BIG SIDE ELEMENT - LH
- BIG CENTRAL ELEMENT
- BIG CORNER
- BIG SIDE ELEMENT - RH

COMFORT 8

3,25

179

23