

OVIDIO

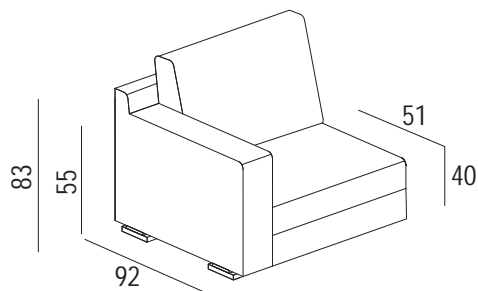



- IT** **STRUTTURA:** costruita in abete massello e multistrato e rivestita in poliuretano espanso. Parti secondarie e non strutturali in pannelli di fibra di legno.  
**SEDUTE:** imbottite in poliuretano espanso ad alta densità rivestite con dacron.  
**SCHIENALI:** imbottiti in poliuretano espanso ad alta densità rivestiti con dacron.  
**PIEDINI:** in legno, finitura colore rovere moro. In acciaio, finitura lucida.  
**SFODERABILITÀ:** totalmente sfoderabile in tessuto, parzialmente sfoderabile nella versione pelle.

- UK** **STRUCTURE:** made of solid and plywood spruce and covered with expanded polyurethane. Secondary and non-structural parts in fibreboard panels.  
**SEATS:** padded with high density expanded polyurethane foam covered with synthetic batting.  
**BACKS:** padded with high density expanded polyurethane foam.  
**FEET:** dark oak wood or glossy steel.  
**REMOVABLE COVERS:** totally removable for fabrics, partially removable for the leather version.

# OVIDIO

\* tessuto tinta unita h. 1,4 mt

\* plain colour fabric h. 1,4 mt

codice

code

vol. m<sup>3</sup>

peso | weight kg

\* ml occorrenti

\* lm employed

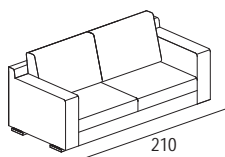

**DIVANO 3 POSTI**  
3-SEATER SOFA

**0600603**

1,60  
53

9,5

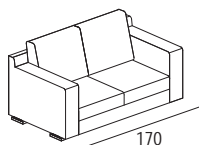

**DIVANO 2 POSTI**  
2-SEATER SOFA

**0600602**

1,30  
43

8,5

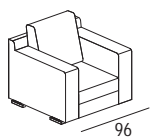

**POLTRONA**  
ARMCHAIR

**0600601**

0,73  
25

5

SX  
LH

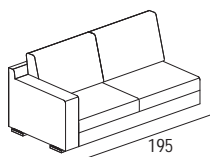

**LATERALE 3 POSTI**  
3-SEATER SIDE ELEMENT

**0600604**

1,49  
50

8,5

SX  
LH

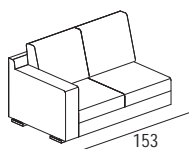

**LATERALE 2 POSTI**  
2-SEATER SIDE ELEMENT

**0600605**

1,17  
39

6,5

SX  
LH

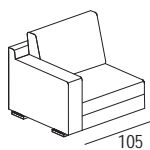

**LATERALE 1 POSTO**  
1-SEATER SIDE ELEMENT

**0600615**

0,80  
20

5

DX  
RH

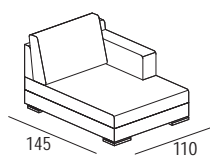

**ISOLA GRANDE**  
BIG SECTIONAL ELEMENT

**0600607**

1,33  
39

6,5

DX  
RH

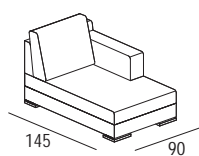

**ISOLA PICCOLA**  
SMALL SECTIONAL ELEMENT

**0600613**

1,08  
34

6

# OVIDIO

\* tessuto tinta unita h. 1,4 mt

\* plain colour fabric h. 1,4 mt

codice

code

vol. m<sup>3</sup>

peso | weight kg

\* ml occorrenti

\* lm employed

DX

RH

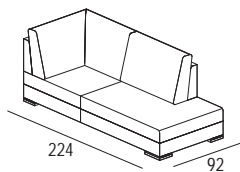

MERIDIANA

CHAISE LONGUE

**0600606**

1,71

60

10,5

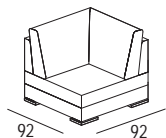

ANGOLO

CORNER

**0600614**

0,70

35

6,5

DX

RH

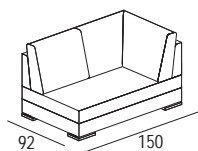

ANGOLO TERMINALE

SIDE END CORNER

**0600612**

1,14

40

7,5

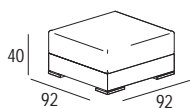

POUF QUADRATO

SQUARE POUF

**0600600**

0,33

20

3

OPTIONAL

Cuscino | Cushion  
65 x 65

**06CUSC3**

0,004

0,3

0,65



Cuscino | Cushion  
45 x 45

**06CUSC1**

0,003

0,3

0,55

\* tessuto tinta unita h. 1,4 mt  
 \* plain colour fabric h. 1,4 mt

codice  
code

vol. m<sup>3</sup>  
peso | weight kg

\* ml occorrenti  
\* lm employed

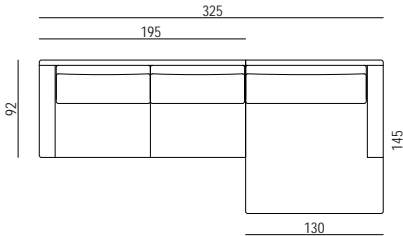

- LATERALE 3 POSTI SX
- ISOLA GRANDE DX

- 3-SEATER SIDE ELEMENT - LH
- BIG SECTIONAL ELEMENT - RH

**OVIDIO 1**

3,05  
89

15

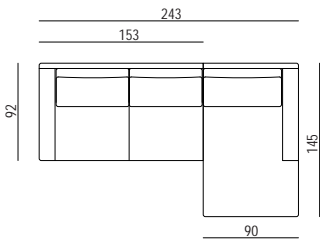

- LATERALE 2 POSTI SX
- ISOLA PICCOLA DX

- 2-SEATER SIDE ELEMENT - LH
- SMALL SECTIONAL ELEMENT - RH

**OVIDIO 2**

2,25  
73

12,5

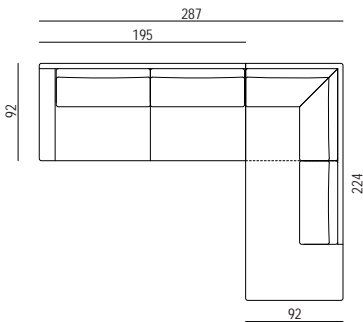

- LATERALE 3 POSTI SX
- MERIDIANA DX

- 3-SEATER SIDE ELEMENT - LH
- CHAISE LONGUE - RH

**OVIDIO 3**

3,20  
110

19

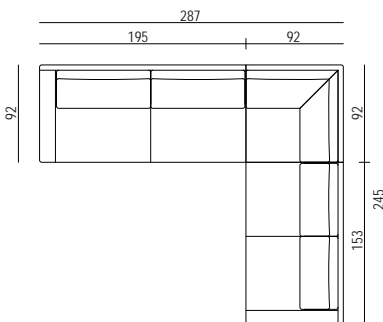

- LATERALE 3 POSTI SX
- ANGOLO
- LATERALE 2 POSTI DX

- 3-SEATER SIDE ELEMENT - LH
- CORNER
- 2-SEATER SIDE ELEMENT - RH

**OVIDIO 4**

3,36  
124

21,5