

Gamma colori - <i>Colour range</i>	P. <b>2</b>
Presentazione sistema armadi - <i>Wardrobe system presentation</i>	P. <b>4</b>
Caratteristiche tecniche - <i>Technical characteristics</i>	P. <b>6</b>

## BATTENTE - *REGULAR DOOR*

Caratteristiche dimensionali - <i>Dimensional characteristics</i>	P. <b>10</b>
Caratteristiche fianchi e divisioni - <i>Side panels and partitions characteristics</i>	P. <b>14</b>
Maniglie - <i>Handles</i>	P. <b>17</b>
Tipologie di ante - <i>Types of doors</i>	P. <b>18</b>
Fianchi e divisioni - <i>Side panels and partitions</i>	P. <b>24</b>
Anta Termoformata, Sprint, Simply e Simply vetro - <i>Thermoformed, Sprint, Simply and Simply vetro door</i>	P. <b>26</b>
Angolo spogliatoio - <i>Walk-in corner</i>	P. <b>30</b>
Anta Tecno e Tecno vetro - <i>Tecno and Tecno vetro door</i>	P. <b>38</b>
Anta Glass - <i>Glass door</i>	P. <b>52</b>
Elemento ponte - <i>Bridge element</i>	P. <b>56</b>
Piani scrivania - <i>Desk tops</i>	P. <b>64</b>
Scocche vuote e abaco ante - <i>Empty structures and doors list</i>	P. <b>66</b>
Anta battente Cubo - <i>Regular Cubo door</i>	P. <b>72</b>
Composizioni fotografiche - <i>Photo compositions</i>	P. <b>77</b>

## SCORREVOLE - *SLIDING DOOR*

Caratteristiche dimensionali - <i>Dimensional characteristics</i>	P. <b>84</b>
Caratteristiche fianchi e divisioni - <i>Side panels and partitions characteristics</i>	P. <b>88</b>
Maniglie - <i>Handles</i>	P. <b>89</b>
Tipologie di ante - <i>Types of doors</i>	P. <b>90</b>
Fianchi e divisioni - <i>Side panels and partitions</i>	P. <b>96</b>
Anta Slide, Incisa, Onda e Tecno - <i>Slide, Incisa, Onda and Tecno door</i>	P. <b>98</b>
Anta telaio "O" - <i>Door "O" with frame</i>	P. <b>104</b>
Anta telaio "A" - <i>Door "A" with frame</i>	P. <b>110</b>
Anta telaio "C" - <i>Door "C" with frame</i>	P. <b>116</b>
Anta telaio "D" - <i>Door "D" with frame</i>	P. <b>122</b>
Anta Composta scorrevole - <i>Composta sliding door</i>	P. <b>128</b>
Anta Composta Plus - <i>Composta Plus sliding door</i>	P. <b>134</b>
Anta Green - <i>Green sliding door</i>	P. <b>140</b>
Anta Vertical - <i>Vertical sliding door</i>	P. <b>146</b>
Anta Riga - <i>Riga sliding door</i>	P. <b>152</b>
Anta Composta complanare - <i>Composta flush-fitting door</i>	P. <b>158</b>
Anta Composta Plus complanare - <i>Composta Plus flush-fitting door</i>	P. <b>160</b>
Anta Green complanare - <i>Green flush-fitting door</i>	P. <b>162</b>
Scocche vuote e abaco ante - <i>Empty structures and doors list</i>	P. <b>164</b>
Composizioni fotografiche - <i>Photo compositions</i>	P. <b>182</b>

Attrezzatura interna - <i>Internal equipment</i>	P. <b>188</b>
Soluzioni su misura - <i>Custom solutions</i>	P. <b>199</b>
Modulo ed esempio d'ordine - <i>Form and example of order</i>	P. <b>204</b>
Cabina armadio - <i>Walk-in closet</i>	P. <b>207</b>
Condizioni generali di vendita - <i>General sales conditions</i>	P. <b>248</b>

# EMOTION - GAMMA COLORI | COLOUR RANGE

## ESSENZE | WOODS



rovere moro  
oak in mahogany finish

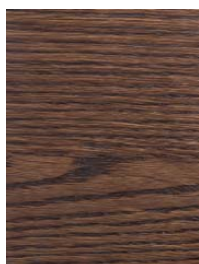

rovere tabacco  
oak in tobacco finish



rovere lacc. poro aperto (disponibile in tutta la gamma colori)  
matt lacquer open pore oak (available in all the colour range)

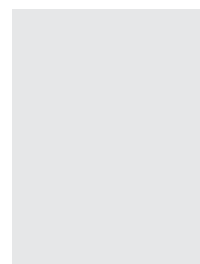

rovere nodi  
oak knots

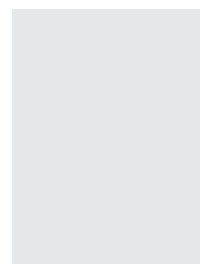

rovere termotrattato  
heat-treated oak

## SUPERFICI TERMOFORMATE | THERMOFORMED SURFACES

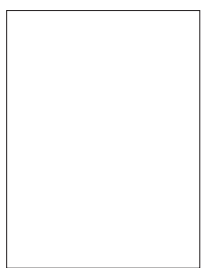

bianco opaco  
matt white

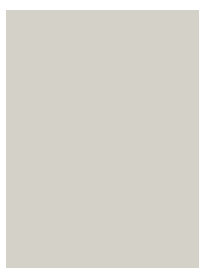

grigio perla opaco  
matt pearl grey

## FINITURA OLMO | ELM FINISH

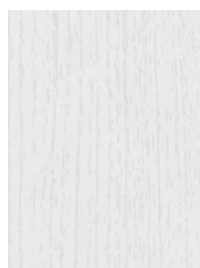

bianco extra  
extra white



beige  
beige



taupe  
taupe

## VETRI | GLASSES

### Cat. 1

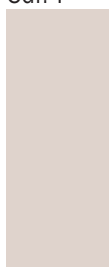

sabbia chiaro  
light sand



sabbia scuro  
dark sand



corda  
rope



grigio pietra  
stone grey



grigio chiaro  
light grey



grigio medio  
medium grey



grigio polvere  
powder grey



blu piombo  
gun metal blue



giallo cromo  
chrome yellow



verde pompelmo  
grapefruit green

### Cat. 1



rosso rubino  
ruby red



nero  
black



stopsol fumé  
smoke-grey stopsol



specchio  
mirror



specchio bronzo  
bronze mirror



specchio fumo  
smoke mirror



trasparente  
transparent

### Cat. 2



bianco  
white



magnolia

\* ATTENZIONE: i vetri stopsol fumé e trasparente lasciano intravedere il telaio sottostante | ATTENTION: the smoke-grey stopsol and transparent glasses allow a glimpse of the underlying frame

# EMOTION - GAMMA COLORI | COLOUR RANGE

## LACCATI OPACHI E LUCIDI | MATT AND GLOSSY LACQUERS

\*\* Laccato opaco base | Basic matt lacquer



bianco 9003  
white



panna 9010  
light cream



fior di loto 1013  
lotus flower



crema 9001  
cream



senape 1024  
mustard



giallo zinco 135  
zinc yellow



giallo cromo 140  
chrome yellow



bruciato 173  
"burned" colour



biscotto 2010  
biscuit



rosso acceso 3001  
fiery red



rosso 3003  
red



rosso bordeaux 3005  
bordeaux red



verde pomplemo 192  
grapefruit green



verde muscio 198  
moss green



verde pallido 190  
pale green



verde petrolio 5021  
petrol green



verde finlandia 199  
Finland green



ghiaccio 9002  
ice



grigio perla 238  
pearl grey



grigio seta 7044  
silk grey



grigio garda 246  
Garda grey



argento 9006  
silver



grigio chiaro 7035  
light grey



grigio polvere 252  
powder grey



blu piombo 255  
gun metal blue



lilla 228  
lilac



tortora  
dove grey



canapa  
hemp



corda  
rope



grigio aston 7039  
aston grey

per interni ed elementi abbinati all'effetto resina  
for inner parts and elements matched with resin effect finish



nero 9017  
black



light grey  
Y18231



dark grey  
Y18232

## MELAMINICI interno armadi | MELAMINE internal wardrobe

Cat. 1

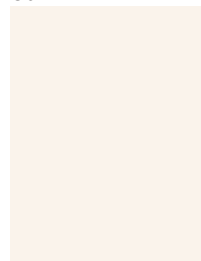

magnolia

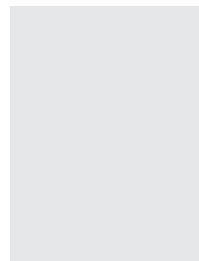

decorativo tessuto  
decorative material



rovere termotrattato  
heat-treated oak

N.B.: La riproduzione dei colori su carta può risultare alterata rispetto agli originali, pertanto queste tinte sono da considerarsi puramente indicative.

N.B.: The reproduction of the colours on paper may be different with respect to the original colours, therefore these shades should be considered representative only.

# EMOTION - PRESENTAZIONE SISTEMA ARMADI BATTENTI | HINGED WARDROBES SYSTEM PRESENTATION

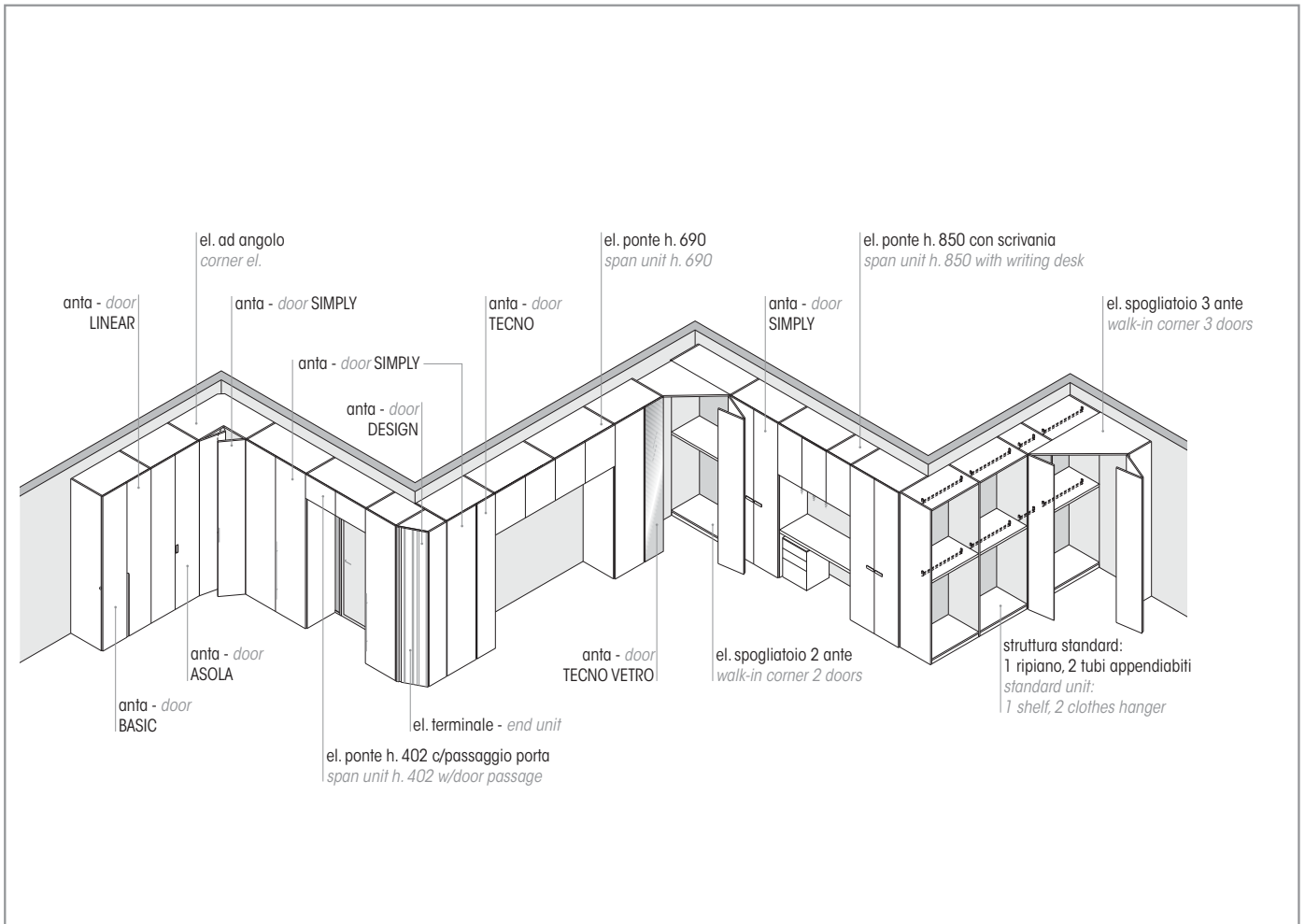

# EMOTION - PRESENTAZIONE INTERNO ARMADI | INTERNAL WARDROBE PRESENTATION

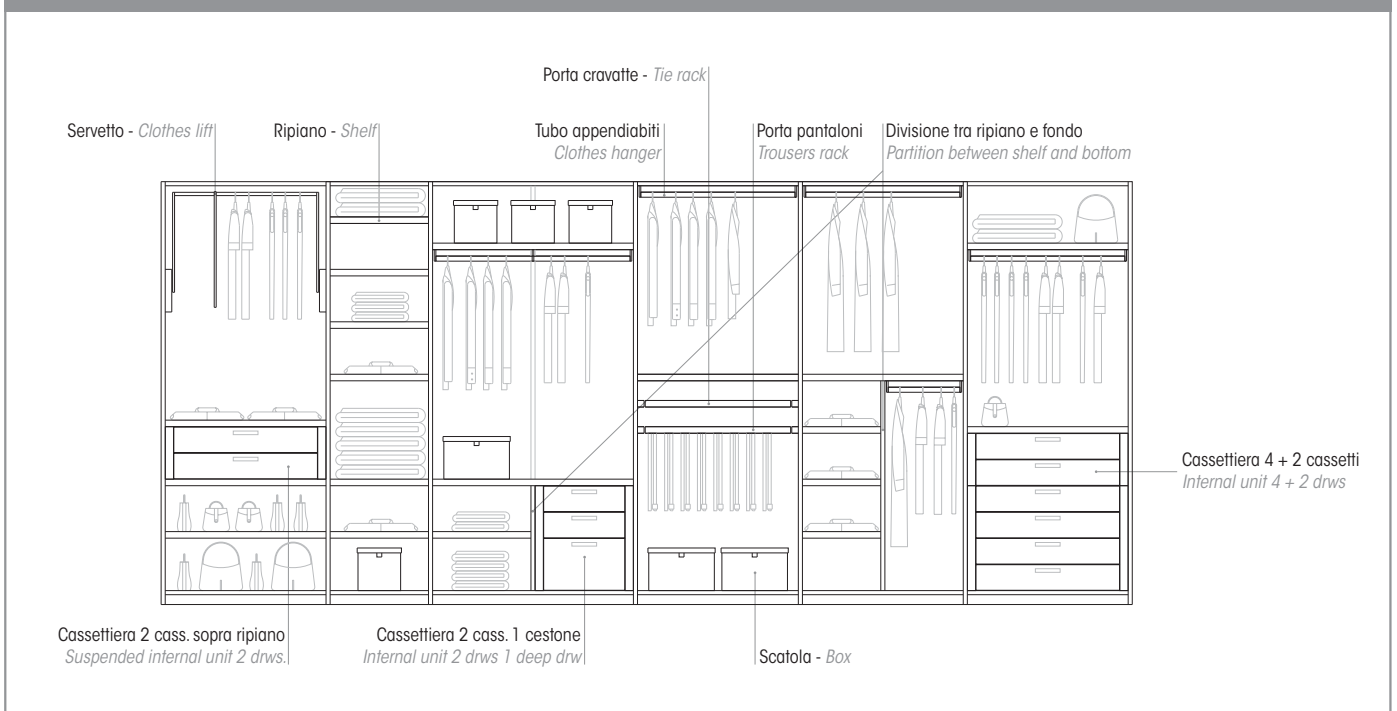

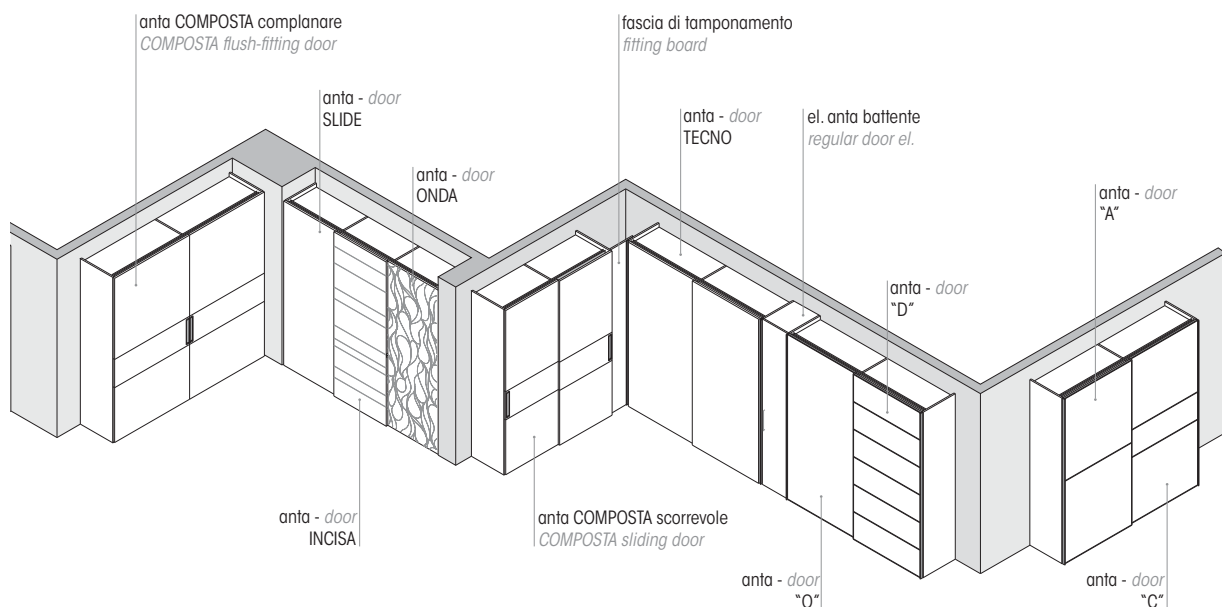

## COMPLETEZZA DI GAMMA - COMPLETENESS OF RANGE

Con tagli al centimetro, in un'ampia gamma di finiture, dalle tinte del laccato ai toni caldi del legno, alle raffinate finiture degli interni, il sistema armadi EMOTION è progettato per avere massima versatilità compositiva ed estetica.

La sua ampia componibilità in **larghezza - 478 - 600 - 700 - 981 - 1225 - 1425** - e in **altezza - 2228 - 2356 - 2580 - 2900** - gli permette di arredare ogni ambiente e di adattarsi ad ogni spazio e nicchia.

Una vasta gamma di ante **battenti, scorrevoli, scorrevoli complanari**, per rispondere ad ogni esigenza di mercato permette infiniti abbinamenti di colori ed essenze. Inoltre ci sono due tipologie di angoli spogliatoio, tre tipologie di elementi ponte, piani scrivania e cassettiere, elementi terminali e ad angolo, molteplici attrezzature interne per risolvere le necessità di ogni giorno, per tutti quegli oggetti, dalle cinture alle cravatte, che vogliamo riporre con cura.

Nelle prossime pagine, sono illustrate tutte le combinazioni e possibilità che permette questo programma.

*With cuts to the centimetre, in a wide range of finishes, from the lacquer shades to the warm wood tones, to the refined interior finishes, the EMOTION wardrobe system is designed for maximum aesthetic and modular versatility.*

*Its wide modularity in **width - 478 - 600 - 700 - 981 - 1225 - 1425** - and in **height - 2228 - 2356 - 2580 - 2900** - allows to decorate any room and adapt to any space and niche.*

*A wide range of **hinged, sliding, flush-fitting** doors to meet every need of the market, allows infinite combinations of colours and woods.*

*In addition, there are two types of walk-in corners, three types of bridge elements, desk tops and chests of drawers, end and corner units, multiple internal pieces of equipment to solve every day needs for all those objects, from belts to ties, we want to store with care.*

*All the combinations and possibilities allowed by this program are shown on the following pages.*

# EMOTION - CARATTERISTICHE TECNICHE | TECHNICAL CHARACTERISTICS

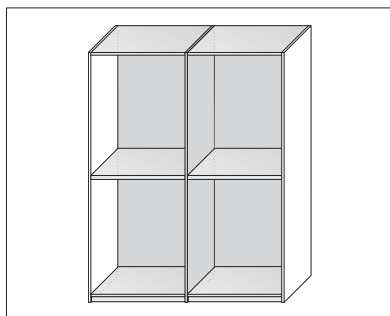

## SCOCHE INTERNE - INTERNAL STRUCTURES

I coperci, i fondi e le divisioni sono spessore 25 mm, i ripiani sp. 40 mm, le schiene sp. 8 mm, tutti realizzati in pannelli di particelle di legno E1 nelle finiture:

- melaminico magnolia
- melaminico decorativo tessuto
- melaminico rovere termotrattato
- laccato opaco disponibile in tutta la gamma colori

Le superfici in tutte le finiture sono trattate per poter garantire lavabilità e un'ottima resistenza all'abrasione e al graffio.

*The tops, bottoms and partitions are 25 mm thick, the shelves 40 mm th., the backs 8 mm th., all made of E1 wood particle board, with the following finishes:*

- magnolia melamine
- decorative material melamine
- heat-treated melamine
- matt lacquer available in all the colour range

*Surfaces in all finishes are washable and treated to provide excellent resistance to abrasion and scratching.*

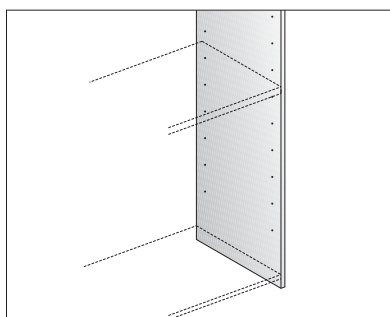

## FIANCHI - SIDE PANELS

I fianchi sono finiti bordati, realizzati in pannelli di particelle di legno E1 spessore 25 mm, in finitura interna come le scocche, finitura esterna:

- impiallacciati essenza rovere moro, rovere tabacco, rovere laccato poro aperto, rovere nodi o rovere termotrattato
- laccati opachi o lucidi in tutta la gamma colori

*The side panels are edge-finished, made of 25 mm thick E1 wood particle panels, with the same internal finishes as the structures and the following external finishes:*

- oak in mahogany finish veneer, oak in tobacco finish, lacquered open pore oak, oak knots or heat-treated oak
- matt or glossy lacquers available in all the colour range

## FORATURA - DRILLING

Nel lato interno è presente una foratura diametro 3 mm a passo 160, per il posizionamento degli eventuali ripiani.

*Internally, on the side, there is a drilling of 3 mm diameter, step 160, for the placement of any extra shelf.*

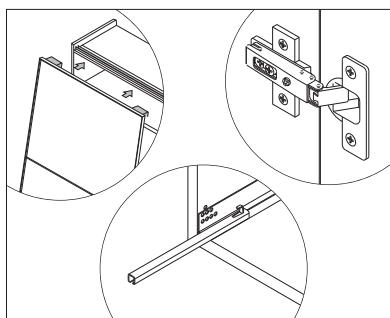

## SISTEMI DI APERTURA-CHIUSURA - OPENING AND CLOSING SYSTEM

Sono previsti quattro differenti tipologie di apertura: - **battente** - **scorrevole** - **scorrevole complanare** - **soffietto** (solo nell'angolo spogliatoio).

Le ante del battente sono dotate di cerniere e basette in metallo finitura nichelata con apertura a 94°, per l'angolo a 180°, con sistema di chiusura ammortizzato (soft). Tutte le cerniere impiegate hanno la regolazione orizzontale, verticale e in profondità e sono certificate C.A.T.A.S. con prove di durata ad 80.000 aperture (UNI 10715/99, par. 10.4). Le ante battenti H. 2208 sono dotate di 4 cerniere, 5 per quelle H. 2336 e 2560, 6 per quelle H. 2880. I binari dell'armadio scorrevole sono dotati di aggancio frontale che permette un rapido sistema di montaggio senza fori a vista e con sistema di chiusura e apertura ammortizzato.

*There are four different types of opening: - hinged - sliding - flush-fitting - folding (only for the walk-in corner unit).*

*The regular doors are equipped with hinges and nickel finish metal bases with an opening at 94°, for the 180° corner unit, with soft closing system (soft). All hinges can be adjusted horizontally, vertically and in depth and are C.A.T.A.S certified with endurance testing at 80.000 openings (UNI 10715/99, par. 10.4). The regular doors H. 2208 are equipped with 4 hinges, 5 for H. 2336 and 2560 doors, 6 for H. 2880 doors.*

*The sliding rails of the wardrobe are equipped with front fastening system that allows quick installation without open drilling and with soft closing and opening system.*



## CASSETTIERE INTERNE - INTERNAL DRAWERS

Le cassettiere interne sono disponibili in tutte le larghezze dei vani degli armadi e nelle altezze 320 e 640, impilabili per creare infinite varianti (previste con frontali cassetto h. 157 in legno o telaio vetro trasparente).

Sono disponibili nelle finiture:

- melaminico magnolia
- melaminico decorativo tessuto
- melaminico rovere termotrattato
- laccato opaco disponibile in tutta la gamma colori

I cassetti e i cestoni delle cassettiere sono ad estrazione parziale con chiusura ammortizzata.

*The internal drawers are available in all widths of the units and in heights 320 and 640, stackable to create endless variations (drawer fronts h. 157 are available in wood or transparent glass framed finish). Available in finishes:*

- magnolia melamine
- decorative material melamine
- heat-treated oak
- matt lacquer available in all the colour range

*All drawers and baskets of the chests are supplied with partial extraction and soft closing system.*

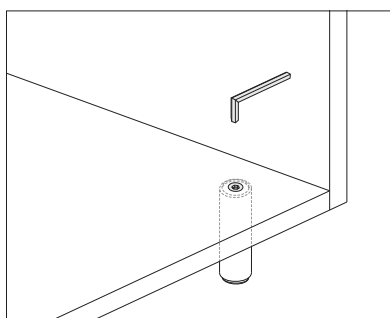

## REGOLAZIONE - ADJUSTMENT

La regolazione per la messa a bolla avviene tramite piedini livellatori, posizionati sul fondo dell'armadio e regolabili con chiave a brugola.

*The adjustment for levelling occurs through the levelling feet, positioned on the bottom of wardrobe, and adjustable with allen key.*

## ILLUMINAZIONE - LIGHTING

Sono previsti due sistemi di illuminazione a led, uno con sensori di presenza per l'interno degli armadi, e uno con sistema touch da usare nei pannelli sotto il ponte.

*There are two LED lighting systems, one with sensors for the interior of the wardrobes, and the other with touch system to be used on underbridge panels.*

# EMOTION - CARATTERISTICHE TECNICHE | TECHNICAL CHARACTERISTICS

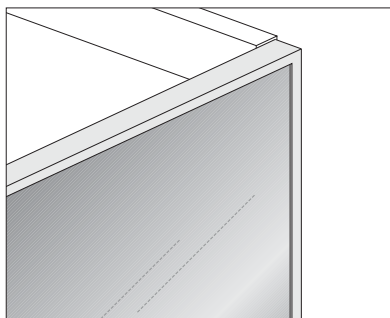

## VERTRI E SPECCHI - GLASSES AND MIRRORS

Disponibili in una vastissima gamma di colori, tutti i vetri e specchi impiegati sono sp. 4 mm.

I vetri all'interno dei telai, sono temperati secondo norme UNI, per garantire l'incolumità dell'utilizzatore in caso di rottura.

Gli specchi se all'interno dei telai, sono forniti con pellicola anti-infortunistica sul lato interno.

Non sono possibili riduzioni di ante con vetri o specchi in quanto sottoposti a questi procedimenti che non permettono in alcun modo di adattarli.

*Available in a wide range of colours, all glass and mirrors are 4 mm th.*

*The framed glasses are tempered according to UNI standards, to ensure the safety of the user in case of breakage.*

*The framed mirrors are supplied with anti-accident film on the inside.*

*Resizing doors with glass or mirrors is not possible, as they are subject to these procedures that do not allow any kind of adjustments.*

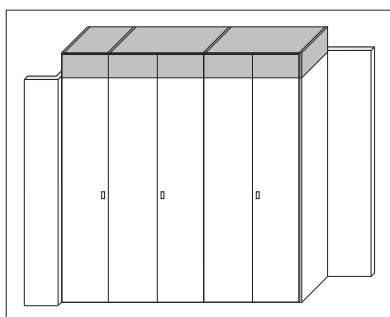

## SOLUZIONI SU MISURA - CUSTOM SOLUTIONS

Molteplici sono le soluzioni su misura che riguardano la possibilità di ridurre in altezza, larghezza e profondità gli armadi.

Un sistema armadi molto flessibile che da la possibilità di adattarsi a tutti gli spazi della casa, grazie alla numerosa modularità prevista e tramite **riduzioni di vani armadio e cassettiere, fasce di tamponamento** verticali e orizzontali, **ante ad uso ripostiglio** e montaggi in nicchia.

Inoltre vi è la possibilità di realizzare laccati a campione su richiesta del cliente comunicando un codice ral di riferimento.

*There are many custom solutions to reduce the height, width and depth of the wardrobes.*

*A very flexible wardrobe system that can adapt to all spaces of the house, thanks to the modularity provided and through **resizing of compartments and drawers, vertical and horizontal fitting boards, doors for storages** and niche assemblies.*

*There is also the possibility of creating sample lacquers on request by communicating a RAL code of reference.*

*In case of a reduction in depth, the wardrobes should always be fixed to the wall for safety.*

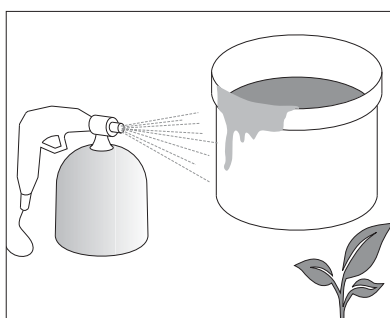

## VERNICI - PAINTS

Le vernici utilizzate sono a basso residuo secco e atossiche. Per le essenze e i laccati opachi il ciclo di verniciatura è ad acqua, mentre per i laccati lucidi a solvente.

Il tipo di finitura per l'essenza è a poro aperto.

*The paints employed are low-residue ones and atoxic. For the wood and lacquered matt finishes, water-borne paints are used.*

*For the lacquered gloss finishes solvent-based paints are used.*

*The wood finish is an open-pore transparent one.*

## TOLLERANZE - TOLERANCES

Le parti con finitura in essenza possono subire nel tempo variazioni di colore dovute alla luce, all'umidità e al passare del tempo.

Esistono anche dei margini di tolleranza dovuti a variazione di prodotto per le finiture laccate.

In caso di un completamento successivo dell'ordine, non si garantisce la perfetta eguaglianza di colori con la composizione originaria.

*The parts with wood finish may change colour over time due to exposure to light and humidity as well as the passing of time.*

*There are also tolerance margins due to product variation for lacquered finishes.*

*In the event of a subsequent order, it is not guaranteed that the colours will match perfectly with the original composition.*

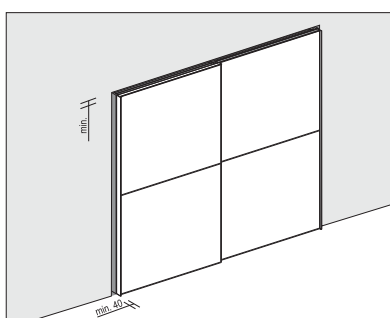

## MONTAGGIO - ASSEMBLY

Per il montaggio del sistema armadi è necessario un ulteriore spazio minimo rispetto alle dimensioni totali della composizione:

- per il battente **25 mm in altezza**

- per lo scorrevole **40 mm in altezza**

- per lo scorrevole con ante complanare **50 mm in altezza**

- per tutti i sistemi di apertura **40 mm in larghezza**

Attenzione: sommare alla misura in larghezza data lo spessore dell'eventuale battiscopa.

*The installation of the wardrobes system requires an additional minimum space compared to the total size of the composition:*

- for regular door wardrobes: **25 mm in height**

- for sliding door wardrobes: **40 mm in height**

- for sliding with flush-fitting door: **50 mm in height**

- for all opening systems, **40 mm in width**

Attention: add the thickness of any skirting to the measurements given.

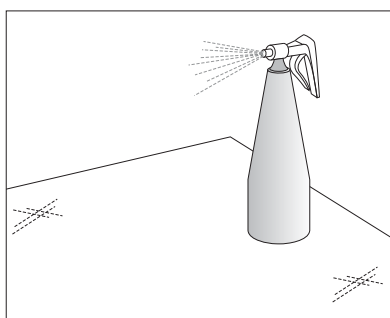

## ISTRUZIONI PER L'USO E LA PULIZIA - INSTRUCTIONS FOR USE AND CLEANING

Per eseguire il montaggio, attenersi alle istruzioni di montaggio.

Le superfici degli armadi sono trattate per garantire una buona resistenza all'usura e al graffio. Per la pulizia e la manutenzione si consiglia di passare sulle superfici un panno morbido inumidito con acqua o eventualmente con aggiunta di detersivi neutri facilmente reperibili sul mercato.

Non usare prodotti contenenti sostanze abrasive, alcol, ammoniaca o altri tipi di solventi.

Si declina ogni responsabilità per inconvenienti dovuti all'uso di prodotti chimici e per usi impropri del prodotto (non utilizzare cassetti o altri elementi per scopi di natura impropria ad esempio come seduta o scala, non sovraccaricare cassettiere e o ripiani con pesi eccessivi...).

*To perform installation, follow the assembly instructions.*

*The surfaces of the wardrobes are treated to ensure good resistance to wear and scratches. For cleaning and maintenance it is recommended to clean surfaces with a soft cloth dampened with water or possibly with the addition of neutral detergent easily available on the market. Do not use products containing abrasives, alcohol, ammonia or other solvents.*

*We accept no responsibility for inconveniences caused by the use of chemicals and improper use of the product (do not use drawers or other elements for purposes of an improper nature, such as sitting or climbing, do not overload drawers and or shelves with heavy weights...).*









# BATTENTE | *REGULAR DOOR*

caratteristiche dimensionali | *dimensional characteristics*

## MODULARITÀ ORIZZONTALE - *HORIZONTAL MODULES*

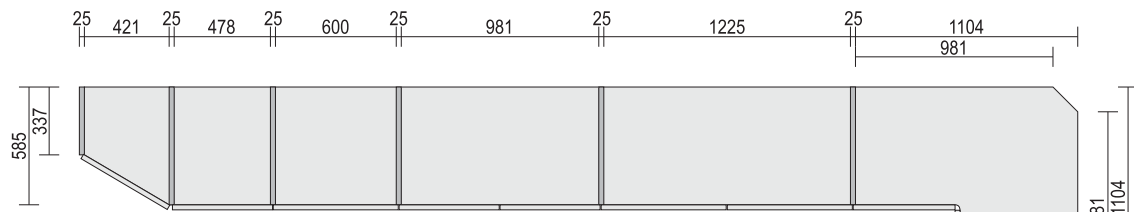

## MODULARITÀ VERTICALE - *VERTICAL MODULES*

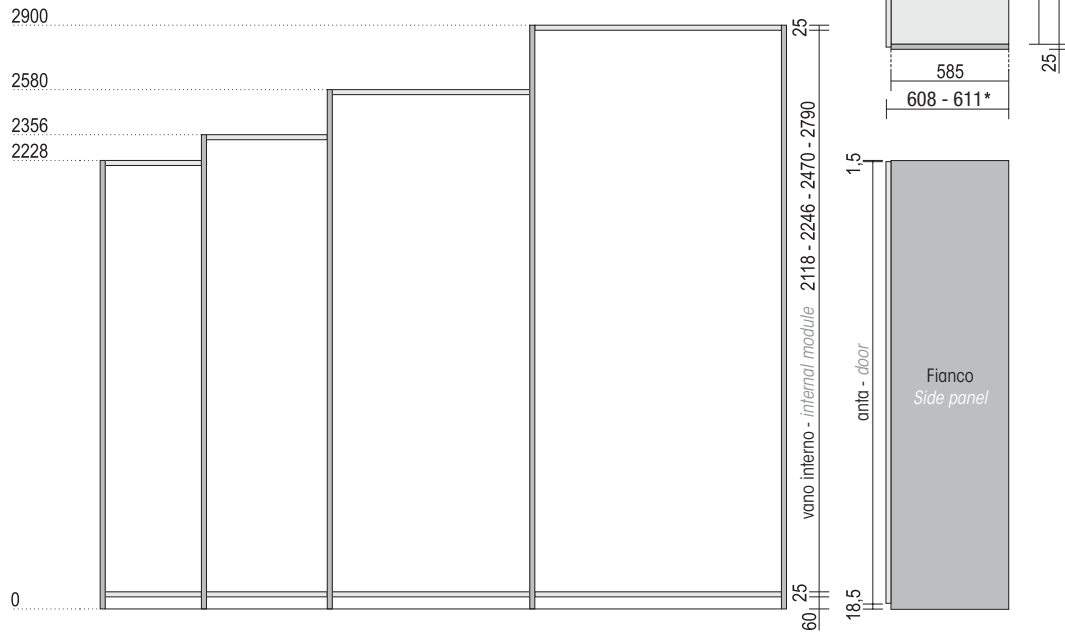



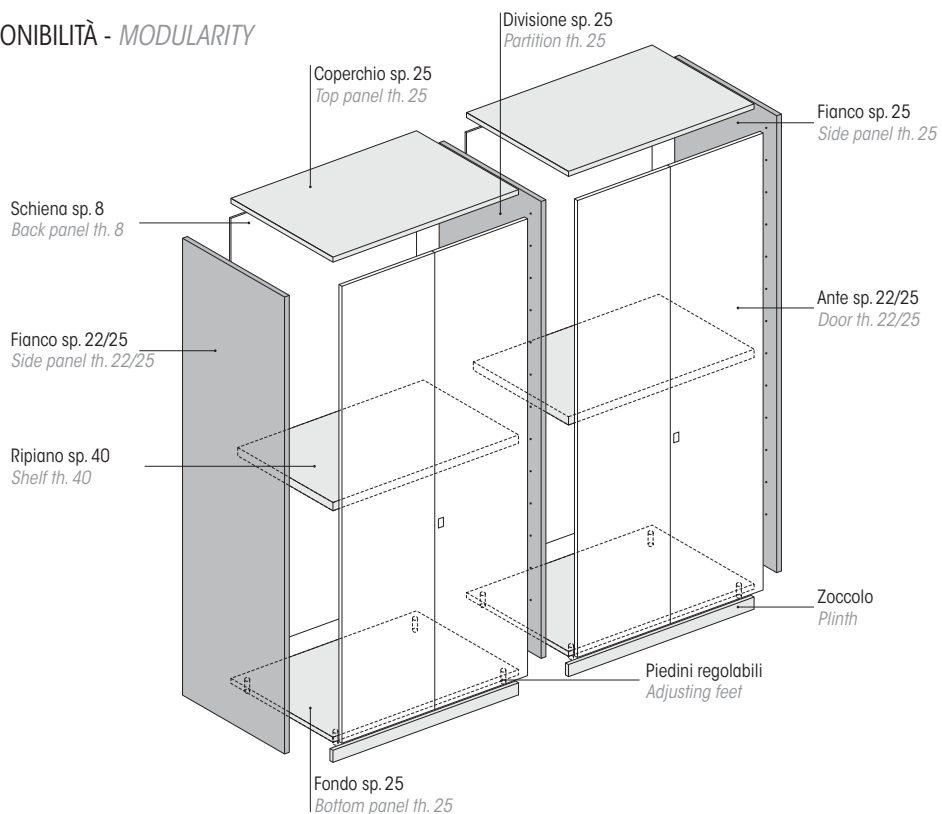











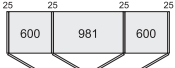
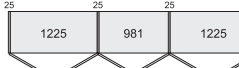

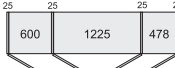

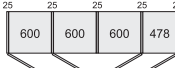

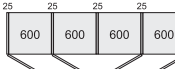



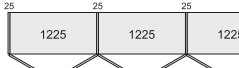
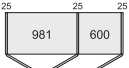
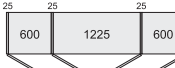
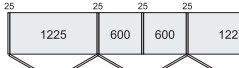
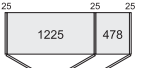

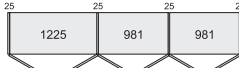
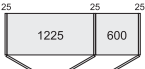
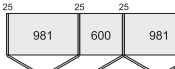
## COMPONIBILITÀ - *MODULARITY*

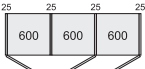
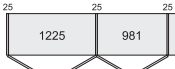

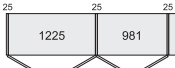
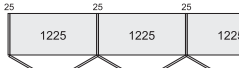
\* Prof. totale armadio:  
608 con anta sp. 22  
611 con anta sp. 25  
\* Wardrobe total depth:  
608 with door th. 22  
611 with door th. 25

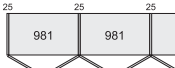
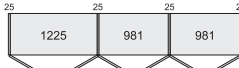
# BATTENTE | *REGULAR DOOR*

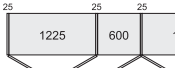
componibilità orizzontale | *horizontal modularity*

larghezza length		larghezza length		larghezza length	
528		2281		3287	
650		2281		3531	
1031		2403		3531	
1153		2403		3546	
1275		2525		3668	
1534		2525		3775	
1656		2525		3775	
1778		2540		3790	
1900		2662		4049	
1900		2784		4293	
2037		2906		4400	
2037		3043		4537	
2281		3150		5025	

# BATTENTE | REGULAR DOOR

caratteristiche dimensionali | *dimensional characteristics*

## TERMINALE - END UNIT

Pianta Dx - Plan Rh

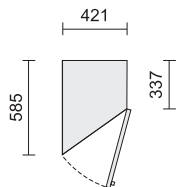

Pianta Sx - Plan Lh

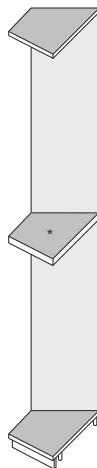
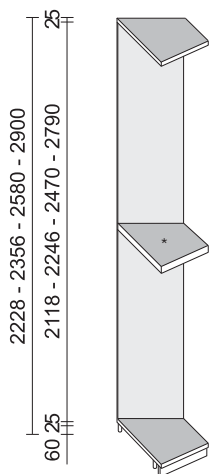
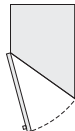

\* vano attrezzabile solo con ripiani sagomati  
\* compartment to be equipped only with shaped shelves\*

### TERMINALE - END UNIT

P. - D. 585 - 337

L. 421

H. 2228 - 2356 - 2580 - 2900

con 1 anta battente - with 1 regular door L. 499

Dotazione interna standard - Standard internal equipment:  
N.1 ripiano - 1 shelf

## ANGOLO - CORNER UNIT

Pianta - Plan

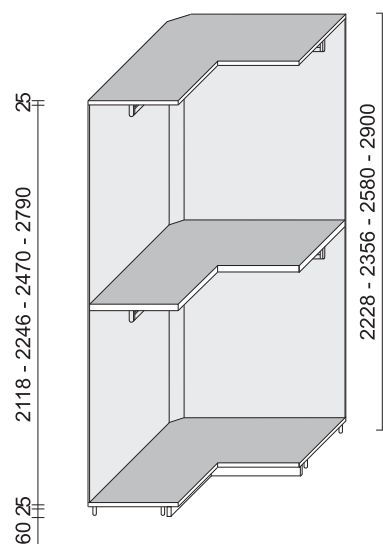
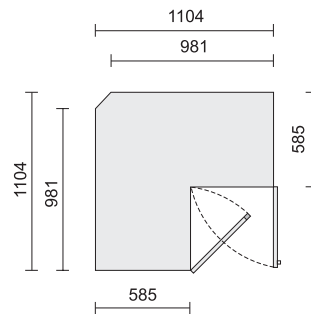

### ANGOLO - CORNER UNIT

P. - D. 1104

L. 1104

H. 2228 - 2356 - 2580 - 2900

con 2 ante battenti - with 2 regular doors L. 499

Dotazione interna standard - Standard internal equipment:  
N.1 ripiano, N.2 tubi appendiabiti - 1 shelf, 2-clothes hangers

# BATTENTE | REGULAR DOOR

caratteristiche dimensionali | *dimensional characteristics*

## ANGOLO SPOGLIATOIO 2 ante - WALK-IN CORNER, 2 doors

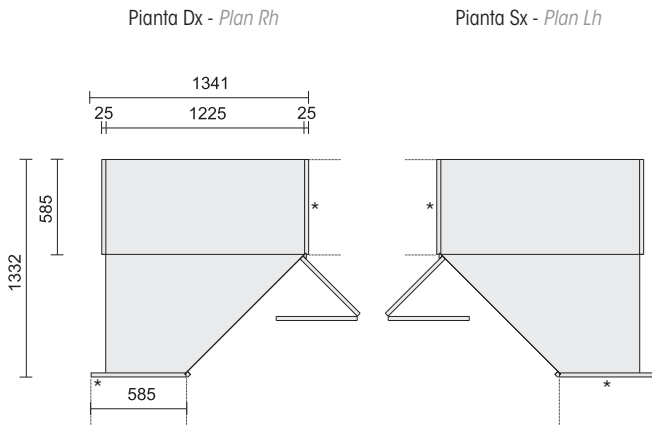

\* Non può essere utilizzato un elemento ponte per la continuazione dell'angolo spogliatoio.

\* *Span unit element cannot be used for continuation of the walk-in corner*

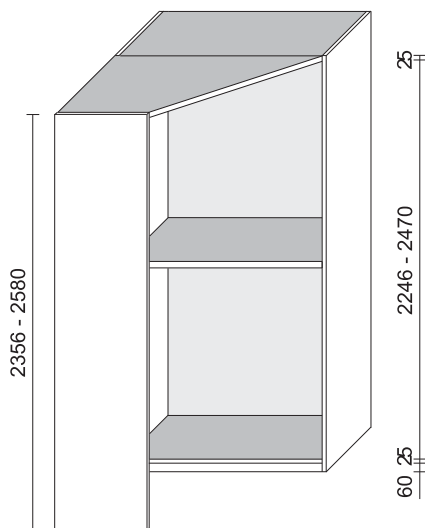

### ANGOLO SPOGLIATOIO 2 ANTE - WALK-IN CORNER, 2-DOORS

P. - D. 1332

L. 1341

H. 2356 - 2580

con 2 ante apertura a soffietto - with 2 folding doors L. 499

Dotazione interna standard - *Standard internal equipment:*  
N.1 ripiano, N.2 tubi appendiabiti - 1 shelf, 2-clothes hangers

## ANGOLO SPOGLIATOIO 3 ante - WALK-IN CORNER, 3 doors

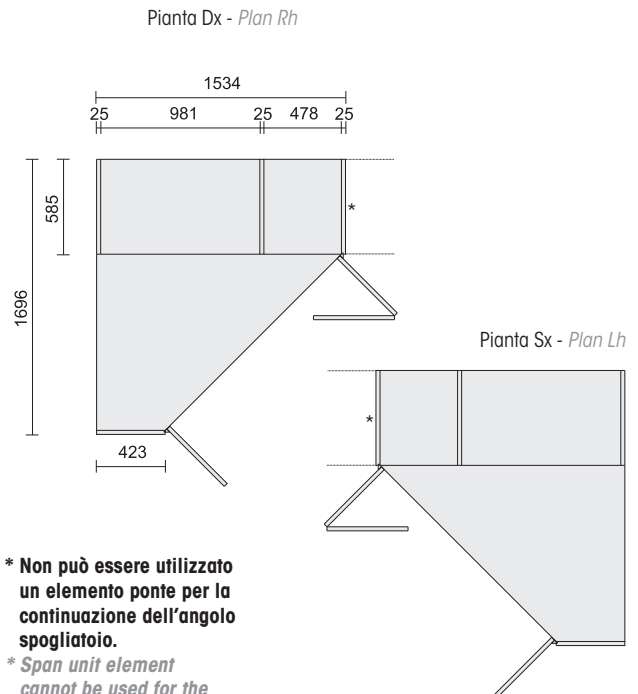

\* Non può essere utilizzato un elemento ponte per la continuazione dell'angolo spogliatoio.

\* *Span unit element cannot be used for the continuation of the walk-in corner.*

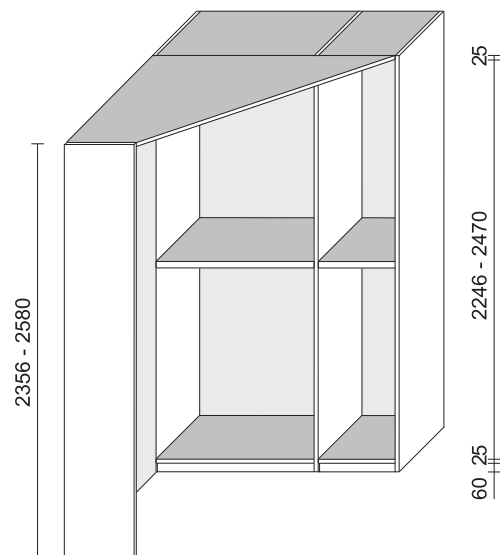

### ANGOLO SPOGLIATOIO 3 ANTE - WALK-IN CORNER, 3-DOORS

P. - D. 1696

L. 1534

H. 2356 - 2580

con 2 ante apertura a soffietto e 1 battente - with 2 folding and 1 regular door L. 499

Dotazione interna standard - *Standard internal equipment:*  
N.1 ripiano, N.2 tubi appendiabiti, per vano - 1 shelf, 2 clothes hangers, per compartment

# BATTENTE | REGULAR DOOR

utilizzo fianchi | employ of side panels

## FIANCO - SIDE PANEL



Pianta - Plan

25/22  
H

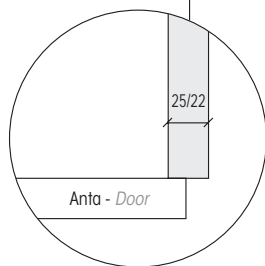
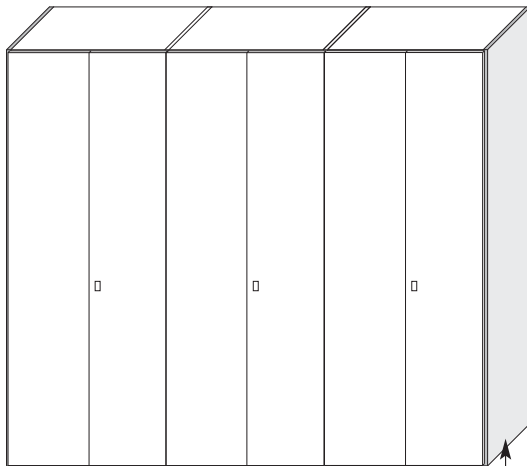
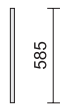

### FIANCO - SIDE PANEL

P. - D. 585

Sp. - Th. 25

H. 2228 - 2356 - 2580 - 2900

Sp. - Th. 22 solo per finitura Olmo - only for Olmo finish

H. 2228 - 2356 - 2580

## FIANCO PER TERMINALE - SIDE PANEL FOR END UNIT



Pianta - Plan

25/22  
H



Divisione standard - Standard partition

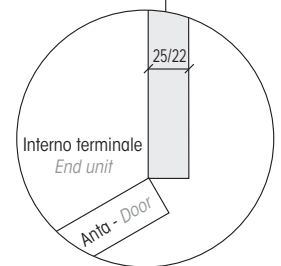
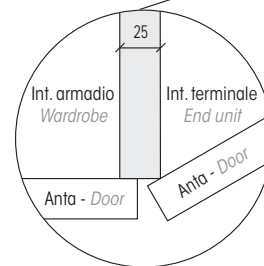
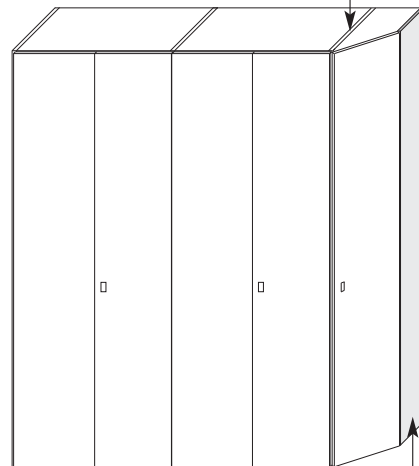

### FIANCO PER TERMINALE - SIDE PANEL FOR END UNIT

P. - D. 337

Sp. - Th. 25

H. 2228 - 2356 - 2580 - 2900

Sp. - Th. 22 solo per finitura Olmo - only for Olmo finish

H. 2228 - 2356 - 2580

# BATTENTE | *REGULAR DOOR*

utilizzo divisioni | *employ of partitions*

## DIVISIONE - *PARTITION*

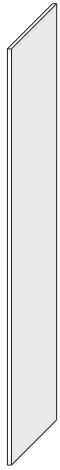

Pianta - *Plan*

25

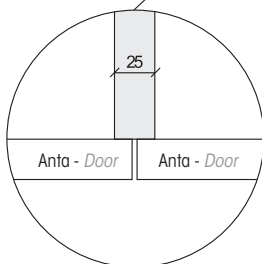
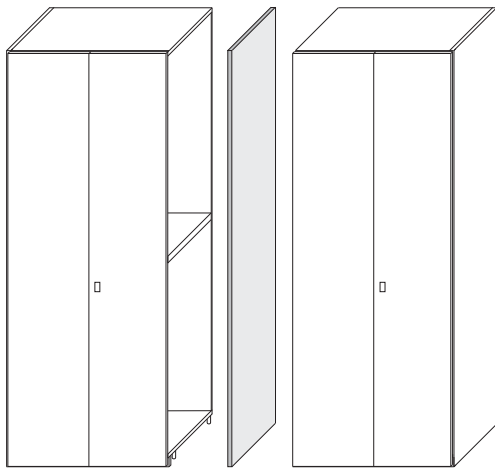
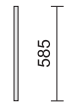

**DIVISIONE - *PARTITION***  
P. - **D. 585**  
Sp. - **Th. 25**  
H. **2228 - 2356 - 2580 - 2900**

## DIVISIONE SPECIALE - *SPECIAL PARTITION*



Pianta - *Plan*

25

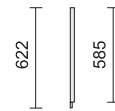

Divisione standard - *Standard partition*

Divisione speciale - *Special partition*

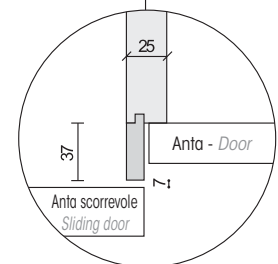
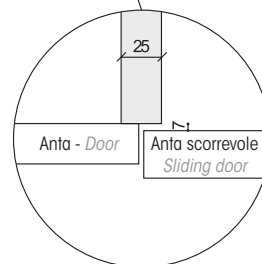
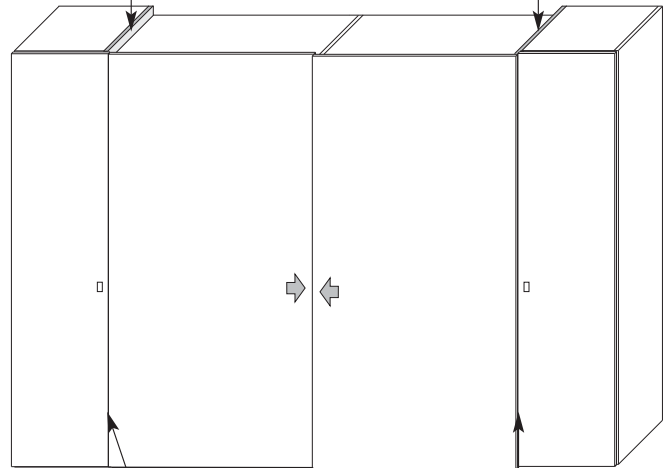

**DIVISIONE SPECIALE tra battente e scorrevole**  
***SPECIAL PARTITION between regular and sliding door***  
P. - **D. 622**  
Sp. - **Th. 25**  
H. **2228 - 2356 - 2580**

# BATTENTE | REGULAR DOOR

caratteristiche fianchi e divisioni | *characteristics of side panels and partitions*

## FIANCHI - SIDE PANELS

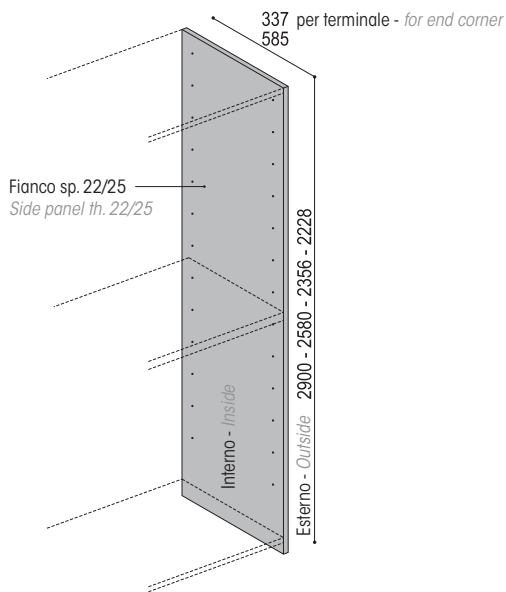

### FINITURE - FINISH

#### Interno - Inside

- melaminico magnolia - *magnolia melamine*
- melaminico decorativo tessuto - *decorative material melamine*
- laccato opaco - *mat lacquer* \*\*
- melaminico rovere termotrattato - *heat-treated oak melamine*

#### Esterno - Outside

- laccato opaco e lucido - *mat and glossy lacquer* \*\*
- rovere moro (venatura orizz.) - *oak in mahogany finish (horiz. grain)*
- rovere tabacco (venatura orizz.) - *oak in tobacco finish (horiz. grain)*
- rovere lacc. poro aperto (venatura orizz.) - *lacq. oak open pore (horiz. grain)* \*\*
- rovere nodi (venatura vert.) - *oak knots finish (vertical grain)*
- rovere termotrattato (venatura vert.) - *heat-treated oak (vertical grain)*
- finitura olmo (venatura vert.) - *Elm finish (vertical grain)*

### CARATTERISTICHE TECNICHE - TECHNICAL CHARACTERISTICS

Pannello di particelle di legno di classe E1 sp. 25 mm impiallacciato rovere nella finitura moro - tabacco - lacc. poro aperto - rovere nodi e termotrattato; nobilitato con carta melaminica per i laccati opachi o lucidi.

Pannello di particelle di legno di classe E1 sp. 22 mm, nobilitato carta melaminica finitura olmo, nei colori bianco, beige e taupe.

*25 mm thick E1 wood particle panel veneered with oak in mahogany-tobacco finish - lacq. open pore - oak knots finish - heat-treated oak; melamine paper finished for matt or glossy lacquers.*

*22mm thick E1 wood particle board panel with melamine paper, in white, beige and taupe colour.*

**N.B.:** Nel lato interno è presente una foratura diametro 3 mm a passo 160, per il posizionamento degli eventuali ripiani.

*Note.: Internally, on the side, there is a drilling of 3 mm diameter, step 160, for the placement of shelves.*

## DIVISIONI - PARTITIONS

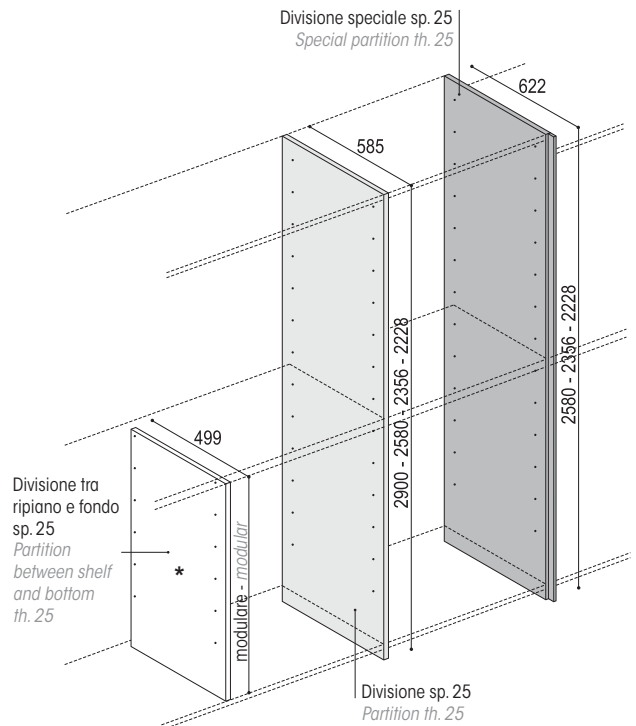

### FINITURE - FINISH

- melaminico magnolia - *magnolia melamine*
- melaminico decorativo tessuto - *decorative material melamine*
- melaminico rovere termotrattato - *heat-treated oak melamine*
- laccato opaco - *mat lacquer* \*\*

### CARATTERISTICHE TECNICHE - TECHNICAL CHARACTERISTICS

Pannello di particelle di legno di classe E1 sp. 25 mm nobilitato con carta melaminica finitura magnolia, decorativo tessuto e rovere termotrattato; disponibile anche laccato opaco.

*25 mm thick E1 wood particle panel with melamine paper, magnolia or decorative material finish and heat-treated oak; also matt lacquer.*

**N.B.:** Nelle divisioni è presente una foratura diametro 3 mm a passo 160, per il posizionamento degli eventuali ripiani. La divisione tra ripiano e fondo viene tagliata in base all'utilizzo a passo 160 mm.

*Note.: Internally, on the side, there is a drilling of 3 mm diameter, step 160, for the placement of shelves. The partition between shelf and bottom is cut depending on use with step 160 mm.*

\*\* disponibile in tutta la gamma colori - *available in all the colour range*



# BATTENTE | REGULAR DOOR

maniglie | handles

MANIGLIE TIPOLOGIA ANTE  
HANDLES TYPES OF DOORS

ALFA	BETA	DELTA	VIP	OMEGA	RETTA	GAMMA	serratura con chiave lock with key
		 Sezione Section					

## FINITURE - FINISHES

Nichel satinato Satin nickel	Nichel satinato Satin nickel	Lacc. opaco ** Matt lacquer **	Brunito - Burnished Bianco - White Lacc. opaco ** Matt lacquer **	Laccato tinta olmo Lacquered Elm finish Lacc. opaco ** Matt lacquer **	Essenza - Wood Lacc. opaco e lucido ** Matt-glossy lacquer **	Cromo Chrome	Alluminio Aluminium
---------------------------------	---------------------------------	-----------------------------------	--	---	--	-----------------	------------------------

## LUNGHEZZA E POSIZIONAMENTO - LENGTH AND POSITIONING

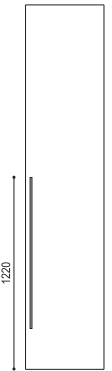
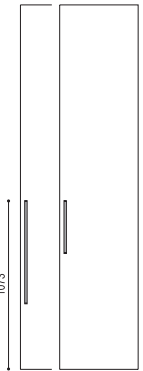
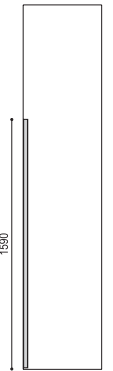
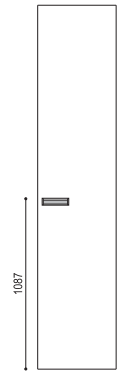
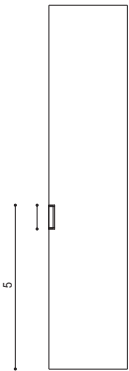
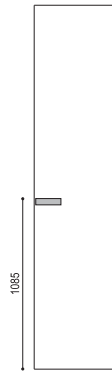
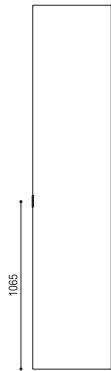
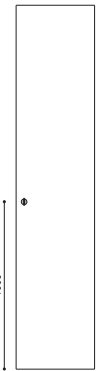
<b>L. 960</b>	<b>L. 655 - 335</b>	<b>L. 1580</b>	<b>L. 170</b> ad incasso - built-in	<b>L. 170</b> ad incasso - built-in	<b>L. 160</b>	<b>L. 65</b>	<b>L. 28</b>
							

## UTILIZZABILE NELL'ANTA - TO BE USED WITH DOOR

BASIC SIMPLY SPRINT	BASIC SIMPLY SPRINT	SIMPLY SPRINT	BASIC SIMPLY SPRINT	SIMPLY SPRINT	BASIC SIMPLY SPRINT	SIMPLY VETRO	SIMPLY
---------------------------	---------------------------	------------------	---------------------------	------------------	---------------------------	--------------	--------

## CODICE E PREZZO - CODE AND PRICE

<b>43</b>	L. 655 <b>34</b>	<b>78</b>	Brunito-Bianco Burnish.-White <b>33</b>	Lacc. opaco Matt lacquer <b>43</b>	Essenza-L. opaco Wood-Matt lacq. <b>38</b>	<b>22</b>	<b>49</b>
	L. 335 <b>25</b>		Lacc. opaco Matt lacquer <b>43</b>		Lacc. lucido Glossy lacquer <b>43</b>		

\*\* disponibile in tutta la gamma colori - available in all the colour range

# BATTENTE | *REGULAR DOOR*

tipologia di ante | *door type*

## BASIC anta battente - *regular door*

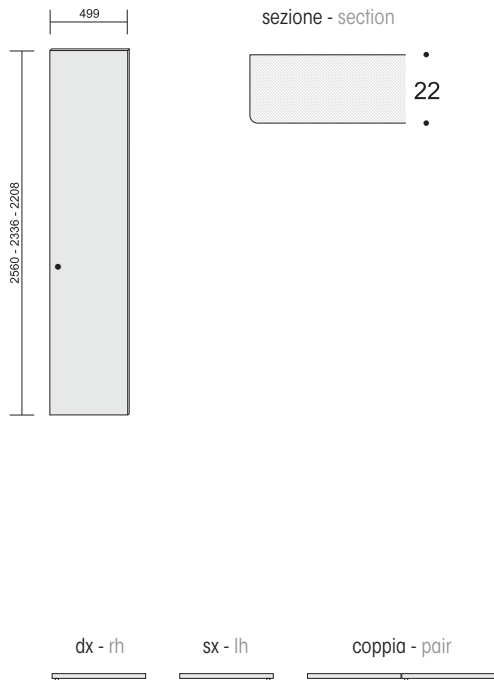

### FINITURE - FINISHES

- superficie termoformata opaco bianco - *thermoformed surface, white matt*
- superficie termoformata opaco grigio perla - *thermoformed surface, pearl grey matt*
- superficie termoformata laccata opaca - *thermoformed surface, matt lacquer \*\**

### CARATTERISTICHE TECNICHE - TECHNICAL CHARACTERISTICS

Pannello di particelle di legno di media densità classe E1 sp. 22 mm rivestito in una lamina termoformata finitura opaca.

22 mm th. E1 medium density particle board panel covered with a thermoformed sheet, matt finish.

### MANIGLIE UTILIZZABILI - HANDLES AVAILABLE

- Alfa
- Beta
- Retta
- Vip

### MODULARITÀ PREVISTA - PROVIDED MODULARITY

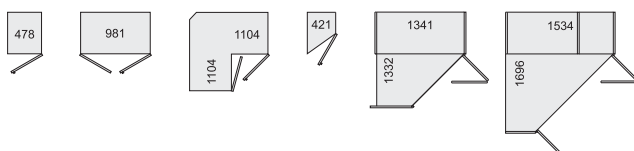

## ASOLA - LINEAR anta battente - *regular door*

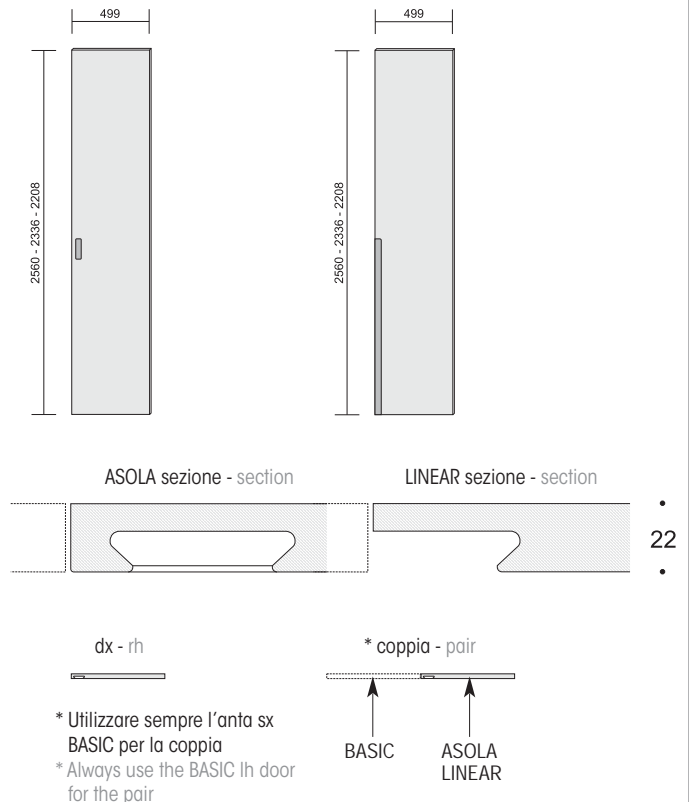

### FINITURE - FINISHES

- superficie termoformata opaco bianco - *thermoformed surface, white matt*
- superficie termoformata opaco grigio perla - *thermoformed surface, pearl grey matt*
- superficie termoformata laccata opaca (solo per Linear) - *thermoformed surface, matt lacquer (only for Linear) \*\**

### CARATTERISTICHE TECNICHE - TECHNICAL CHARACTERISTICS

Pannello di particelle di legno di media densità classe E1 sp. 22 mm rivestito in una lamina termoformata finitura opaca.

22 mm th. E1 medium density particle board panel covered with a thermoformed sheet, matt finish.

### MODULARITÀ PREVISTA - PROVIDED MODULARITY



\*\* disponibile in tutta la gamma colori - *available in all the colour range*

# BATTENTE | *REGULAR DOOR*

tipologia di ante | *door type*

## DESIGN anta battente - *regular door*

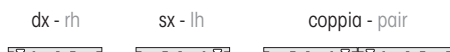
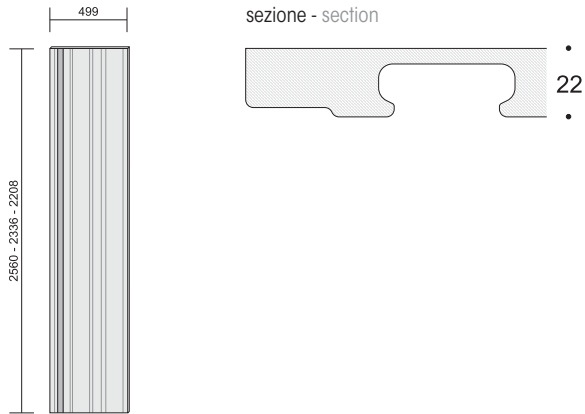

### FINITURE - FINISHES

- superficie termoformata opaco bianco - *thermoformed surface, white matt*

### CARATTERISTICHE TECNICHE - TECHNICAL CHARACTERISTICS

Pannello di particelle di legno di media densità classe E1 sp. 22 mm rivestito in una lamina termoformata finitura opaca.

*22 mm th. E1 medium density particle board panel covered with a thermoformed sheet, matt finish.*

### MODULARITÀ PREVISTA - PROVIDED MODULARITY

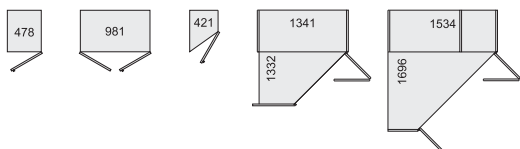

# BATTENTE | *REGULAR DOOR*

tipologia di ante | *door type*

## SIMPLY anta battente - *regular door*



### FINITURE - FINISHES

- laccato opaco e lucido - *mat and glossy lacquer* \*\*
- rovere moro (venatura orizz.) - *oak in mahogany finish (horiz. grain)*
- rovere tabacco (venatura orizz.) - *oak in tobacco finish (horiz. grain)*
- rovere lacc. poro aperto (venatura orizz.) - *lacq. oak open pore (horiz. grain)* \*\*
- rovere nodi (venatura vert.) - *oak knots (vertical grain)*
- rovere termotrattato (venatura vert.) - *heat-treated oak (vertical grain)*

### CARATTERISTICHE TECNICHE - TECHNICAL CHARACTERISTICS

Pannello di particelle di legno di classe E1 sp. 25 mm impiallacciato rovere nella finitura moro - tabacco - lacc. poro aperto - rovere nodi - rovere termotrattato; nobilitato con carta melaminica per i laccati opachi o lucidi.  
 25 mm thick E1 wood particle panel veneered with oak in mahogany-tobacco finish - lacq. open pore - oak knots - heat-treated oak; laminated with melamine paper for matt or glossy lacquers.

### MANIGLIE UTILIZZABILI - HANDLES AVAILABLE

- Alfa - Beta - Delta - Vip - Omega - Retta
- Serratura con chiave - *Lock with key*

### MODULARITÀ PREVISTA - PROVIDED MODULARITY

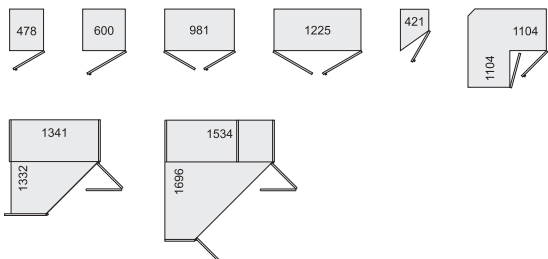

## SIMPLY VETRO anta battente - *regular door*

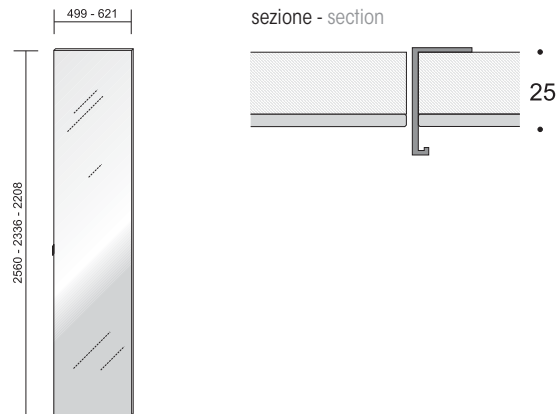

### FINITURE ESTERNE - OUTSIDE FINISHES

- vetro o specchio - *glass or mirror* \*\*

### FINITURE INTERNE - INSIDE FINISHES

- laccato opaco - *matt lacquer* \*\*

### CARATTERISTICHE TECNICHE - TECHNICAL CHARACTERISTICS

Pannello di particelle di legno di classe E1 sp. 20 mm nobilitato con carta melaminica e laccato opaco. Vetro o specchio sp. 4 mm.  
 20 mm thick E1 wood particle panel with melamine paper and matt lacquer. 4 mm th. glass or mirror.

### MANIGLIE UTILIZZABILI - HANDLES AVAILABLE

- Gamma

### MODULARITÀ PREVISTA - PROVIDED MODULARITY

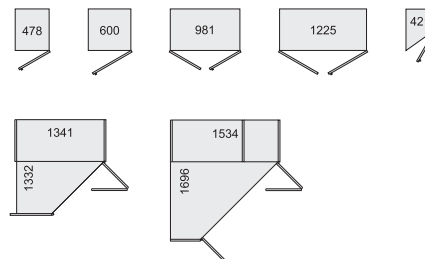

\*\* disponibile in tutta la gamma colori - *available in all the colour range*

# BATTENTE | REGULAR DOOR

tipologia di ante | door type

## TECNO anta battente - regular door

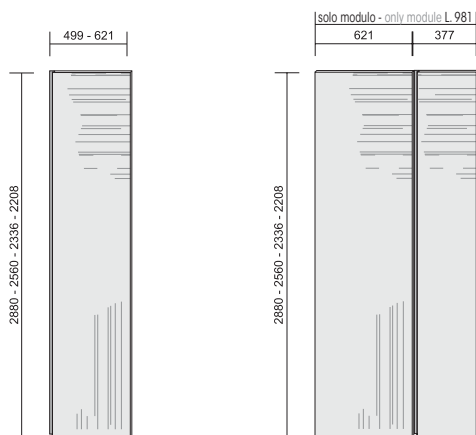

sezione - section



dx - rh

sx - lh

coppia - pair

\* Utilizzare sempre l'anta sx SIMPLY per la coppia

\* Always use the SIMPLY lh door for the pair

SIMPLY

TECNO

### FINITURE - FINISHES

- laccato opaco e lucido - *mat and glossy lacquer* \*\*
- rovere moro (venatura orizz.) - *oak in mahogany finish (horiz. grain)*
- rovere tabacco (venatura orizz.) - *oak in tobacco finish (horiz. grain)*
- rovere lacc. poro aperto (venatura orizz.) - *lacq. oak open pore (horiz. grain)* \*\*
- rovere nodi (venatura vert.) - *oak knots (vertical grain)*
- rovere termotrattato (venatura vert.) - *heat-treated oak (vertical grain)*

### CARATTERISTICHE TECNICHE - TECHNICAL CHARACTERISTICS

Pannello di particelle di legno di classe E1 sp. 25 mm impiallacciato rovere nella finitura moro - tabacco - lacc. poro aperto - rovere nodi - rovere termotrattato; nobilitato con carta melaminica per i laccati opachi o lucidi.

25 mm thick E1 wood particle panel veneered with oak in mahogany-tobacco finish - lacq. open pore - oak knots - heat-treated oak; laminated with melamine paper for mat or glossy lacquers.

**MANIGLIA:** inserita per tutta la lunghezza dell'anta, disponibile in finitura bianco, brill spazzolato e laccato opaco colore \*\*

*HANDLE: built-in along the length of the door, available in white finish, brushed brill, and matt lacquer colour \*\**

### MODULARITÀ PREVISTA - PROVIDED MODULARITY

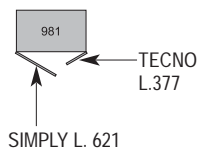
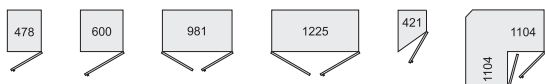

## TECNO VETRO anta battente - regular door

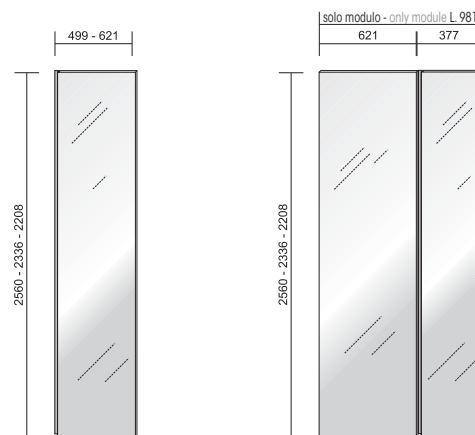

sezione - section



dx - rh

sx - lh

coppia - pair

\* Utilizzare sempre l'anta sx SIMPLY o SIMPLY VETRO per la coppia

\* Always use the SIMPLY lh door or SIMPLY VETRO for the pair

SIMPLY

TECNO

ET O

### FINITURE ESTERNE - OUTSIDE FINISHES

- vetro o specchio - *glass or mirror* \*\*

### FINITURE INTERNE - INSIDE FINISHES

- laccato opaco - *matt lacquer* \*\*

### CARATTERISTICHE TECNICHE - TECHNICAL CHARACTERISTICS

Pannello di particelle di legno di classe E1 sp. 20 mm nobilitato con carta melaminica e laccato opaco. Vetro o specchio sp. 4 mm.

20 mm thick E1 wood particle panel with melamine paper and matt lacquer. 4mm th. glass or mirror.

**MANIGLIA:** inserita per tutta la lunghezza dell'anta, disponibile in finitura bianco, brill spazzolato e laccato opaco colore \*\*

*HANDLE: built-in along the length of the door, available in white finish, brushed brill, and matt lacquer colour \*\**

### MODULARITÀ PREVISTA - PROVIDED MODULARITY

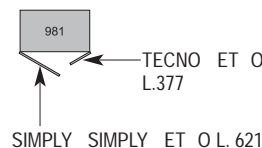
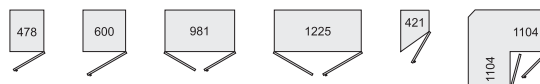

\*\* disponibile in tutta la gamma colori - available in all the colour range

# BATTENTE | *REGULAR DOOR*

tipologia di ante | *door type*

## SPRINT anta battente - *regular door*

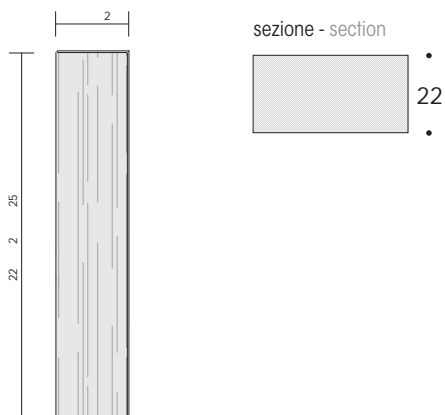

dx - rh    sx - lh    coppia - pair

### FINITURE - FINISHES

- olmo con colori: bianco extra, beige, taupe
- Elm in the following colours: extra white, beige, taupe

### CARATTERISTICHE TECNICHE - TECHNICAL CHARACTERISTICS

Pannello di particelle di legno di classe E1 sp. 22 mm nobilitato con carta melaminica effetto olmo.

22 mm thick E1 class wood particle board panel coated with elm effect melamine paper sheet

### MANIGLIE UTILIZZABILI - HANDLES AVAILABLE

- ALFA
- BETA
- VIP
- OMEGA
- DELTA
- RETTA

### MODULARITÀ PREVISTA - PROVIDED MODULARITY

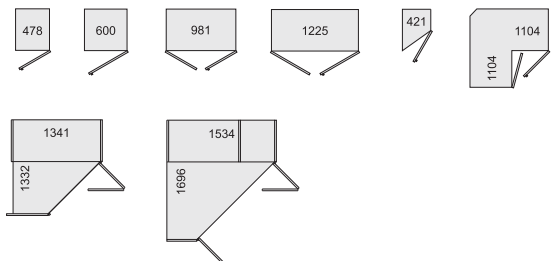

## SPRINT PLUS anta battente - *regular door*

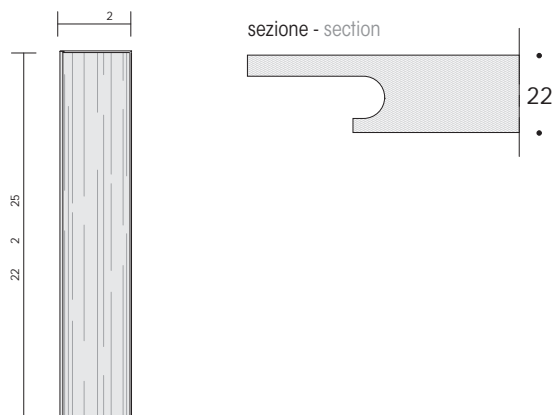

dx - rh    sx - lh    coppia - pair

↑ SP INT    ↑ SP INT  
PL S

### FINITURE - FINISHES

- olmo con colori: bianco extra, beige, taupe
- Elm in the following colours: extra white, beige, taupe

### CARATTERISTICHE TECNICHE - TECHNICAL CHARACTERISTICS

Pannello di particelle di legno di classe E1 sp. 22 mm nobilitato con carta melaminica effetto olmo.

22 mm thick E1 class wood particle board panel coated with elm effect melamine paper sheet

### MODULARITÀ PREVISTA - PROVIDED MODULARITY

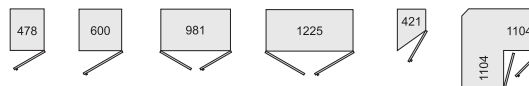

# BATTENTE | *REGULAR DOOR*

tipologia di ante | *door type*

## GLASS VETRO anta battente - *regular door*

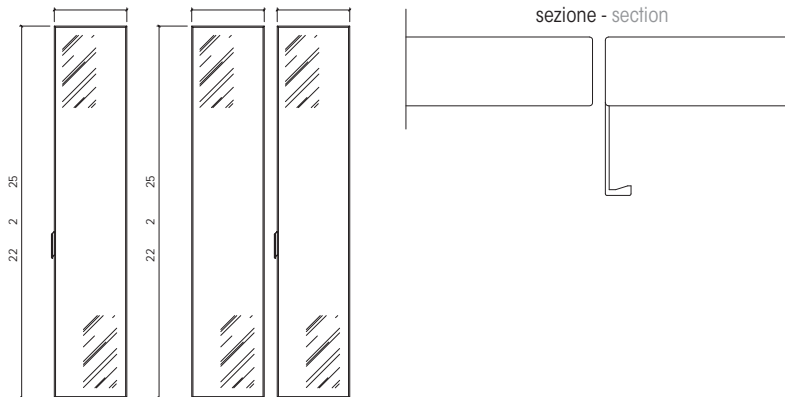

### FINITURE TELAIO - *FRAME FINISHES*

- **brunito** - *burnished*

### FINITURE VETRO - *GLASS FINISHES*

- **vetro trasparente grigio** - *grey transparent glass*

### CARATTERISTICHE TECNICHE - *TECHNICAL CHARACTERISTICS*

Telaio in alluminio finitura brunita, sezione da 20 x 21,5.  
Le cerniere utilizzate **NON HANNO** il sistema di chiusura ammortizzata.  
*Aluminium frame, burnished finish, section 20 x 21,5.*  
*The hinges are not provided with soft closing system.*

### MODULARITÀ PREVISTA - *PROVIDED MODULARITY*

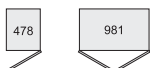

# BATTENTE | REGULAR DOOR

## fianchi | side panels

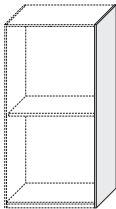
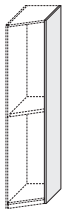
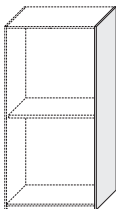
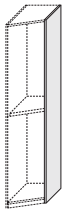
		CODICE	lacc. opaco base	lacc. opaco colore	essenza	rovere lacc. poro aperto	lacc. lucido	rovere termotrattato	finitura olmo	Maggiorazione per interno laccato
		CODE	basic matt lacq.	colour matt lacq.	wood	open pore lacq. oak	glossy lacq.	heat-treated oak	elm finish	Increase for matt lacquered inside finish
<p>- Prezzi di fianchi con finitura interna melaminico, per interno lacc. opaco applicare la maggiorazione.</p> <p>- I fianchi olmo nel lato interno avranno la stessa finitura del lato esterno.</p> <p>- Prices for side panels with melamine inside finish, for matt lacq. inside apply the increase.</p> <p>- The interior face of Elm side panels is provided in the same finish of the outside.</p>										
<p><b>FIANCO   SIDE PANEL</b></p> <p><b>P.   D. 585</b></p> 										
	H. 2228	EMF10522	111	124	156	197	196	190		41
	H. 2356	EMF10523	115	129	162	206	205	200		44
	H. 2580	EMF10524	124	137	174	222	221	213		48
	H. 2900	EMF10525	139	156	194	249	249	238		54
<p><b>FIANCO PER TERMINALE</b></p> <p><b>SIDE PANEL FOR END UNIT</b></p> <p><b>P.   D. 337</b></p> 										
	H. 2228	EMF20222	82	90	110	133	135	134		25
	H. 2356	EMF20223	85	94	114	140	141	140		27
	H. 2580	EMF20224	89	99	121	149	150	148		29
	H. 2900	EMF20225	101	112	135	167	170	166		33
<p><b>FIANCO OLMO Sp. 22</b></p> <p><b>ELM SIDE PANEL Th. 22</b></p> <p><b>P.   D. 585</b></p> 										
	H. 2228	EMF02522							100	
	H. 2356	EMF02523							103	
	H. 2580	EMF02524							109	
<p><b>FIANCO OLMO PER TERMINALE Sp. 22</b></p> <p><b>ELM SIDE PANEL FOR END UNIT Th. 22</b></p> <p><b>P.   D. 337</b></p> 										
	H. 2228	EMF21222							75	
	H. 2356	EMF21223							78	
	H. 2580	EMF21224							82	



# BATTENTE | REGULAR DOOR

divisioni | partitions

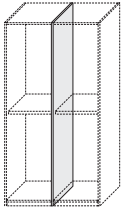
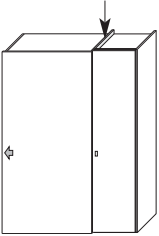
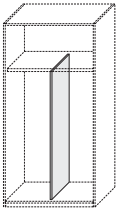
	CODICE	melaminico magnolia	melaminico decorativo tessuto	melaminico rovere termotrattato	lacc. opaco				
	CODE	magnolia melamine	decorative material melamine	heat-treated oak melamine	mat lacq.				
<b>DIVISIONE   PARTITION</b>	<b>P.   D. 585</b>								
	H. 2228	EMD10522	<b>81</b>	<b>81</b>	<b>81</b>	<b>158</b>			
	H. 2356	EMD10523	<b>84</b>	<b>84</b>	<b>84</b>	<b>165</b>			
	H. 2580	EMD10524	<b>88</b>	<b>88</b>	<b>88</b>	<b>178</b>			
	H. 2900	EMD10525	<b>100</b>	<b>100</b>	<b>100</b>	<b>196</b>			
<b>DIVISIONE SPECIALE</b> tra battente e scorrevole <b>SPECIAL PARTITION</b> <i>between regular and sliding door</i>	<b>P.   D. 622</b>								
	H. 2228	EMD30622	<b>190</b>	<b>190</b>	<b>190</b>	<b>268</b>			
	H. 2356	EMD30623	<b>193</b>	<b>193</b>	<b>193</b>	<b>274</b>			
	H. 2580	EMD30624	<b>198</b>	<b>198</b>	<b>198</b>	<b>287</b>			
<b>DIVISIONE</b> tra ripiano e fondo, tagliata a misura modulare passo 160 <b>PARTITION</b> <i>between shelf and bottom, cut to modular size with step 160</i>	<b>P.   D. 499</b>								
		EMD40525	<b>105</b>	<b>105</b>	<b>105</b>	<b>146</b>			

FIANCHI E DIVISIONI  
SIDE PANELS - PARTITIONS

# BATTENTE | REGULAR DOOR

anta con superficie termoformata | door with thermoformed surface

VETRI: cat. 1 sabbia chiaro, sabbia scuro, corda, grigio pietra, grigio chiaro, grigio medio, grigio polvere, blu piombo, giallo cromo, verde pompelmo, rosso rubino, nero, stopsol fumé, specchio, specchio bronzo, specchio fumo. cat. 2 bianco, magnolia.

- Fianchi e divisioni a pag. | Side panels and partitions on page 24

- Prezzi calcolati con interno melaminico.

Dotazione interna vano standard: - N. 1 ripiano - N. 2 tubi appendiabiti

- Prices calculated with melamine finish.

Standard internal equipment: - 1 shelf - 2 clothes hangers









- Maniglie a pag. | Handles on page 17



- L'anta simply vetro è disponibile solo con maniglia Gamma.



The simply vetro door is only available with Gamma handle.



- Maggiorazione per anta Basic, Linear lacc. opaco colore 86 euro.



- Surcharge for matt lacq. colour door mod. Basic, Linear euro 86

BASIC	ASOLA	LINEAR	DESIGN	SPRINT	SPRINT PLUS
					
Sezione ante   Door section:					

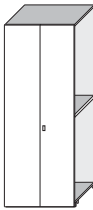
L. 478	H. H.	CODICE CODE	EL. 1 ANTA da 499 mm - escluso di fianchi e divisioni EL. w/1 DOOR 499 mm - side panels and partitions not included					
			BASIC	ASOLA	LINEAR	DESIGN	SPRINT	SPRINT PLUS
		2228 EMMB220	295	321	311	334	274	294
		2356 EMMB320	305	332	321	346	281	303
		2580 EMMB420	316	346	335	360	290	315
		2900 EMMB620						

L. 600	H. H.	CODICE CODE	EL. 1 ANTA da 621 mm - escluso di fianchi e divisioni EL. w/1 DOOR 621 mm - side panels and partitions not included					
			BASIC	ASOLA	LINEAR	DESIGN	SPRINT	SPRINT PLUS
		2228 EMMB230					302	322
		2356 EMMB330					311	334
		2580 EMMB430					321	346
		2900 EMMB630						

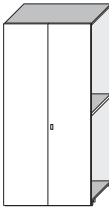
L. 981	H. H.	CODICE CODE	EL. 2 ANTE da 499 mm - escluso di fianchi e divisioni EL. w/2 DOORS 499 mm - side panels and partitions not included					
			BASIC	ASOLA	LINEAR	DESIGN	SPRINT	SPRINT PLUS
		2228 EMMB250	507	533	523	585	465	485
		2356 EMMB350	528	555	544	610	480	502
		2580 EMMB450	548	578	567	636	496	521
		2900 EMMB650						











L. 1225	H. H.	CODICE CODE	EL. 2 ANTE da 621 mm - escluso di fianchi e divisioni EL. w/2 DOORS 621 mm - side panels and partitions not included					
			BASIC	ASOLA	LINEAR	DESIGN	SPRINT	SPRINT PLUS
		2228 EMMB260					582	602
		2356 EMMB360					602	625
		2580 EMMB460					625	650
		2900 EMMB660						

Ulteriori combinazioni di aperture e finiture sono possibili utilizzando le scocche vuote a pag. | Additional finishes and opening combinations are possible using the empty bodies on page 66

# BATTENTE | REGULAR DOOR

simply

GLASSES: **cat. 1** light sand, dark sand, rope, stone grey, light grey, medium grey, powder grey, gun metal blue, chrome yellow, green grass, ruby red, black, smoke-grey stopsol, mirror, bronze mirror, smoke mirror. **cat. 2** white, magnolia.













SIMPLY lacc. opaco base basic matt lacq.	SIMPLY lacc. opaco colore colour matt lacq.	SIMPLY essenza wood	SIMPLY rovere lacc. poro aperto open pore lacq. oak	SIMPLY rovere termotrattato heat-treated oak	SIMPLY lacc. lucido glossy lacq.	SIMPLY VETRO 1 interno lacc. opaco matt lacq. inside	SIMPLY VETRO 2 interno lacc. opaco matt lacq. inside		Maggiorazione per interno laccato opaco  Increase for matt lacquered inside finish
									
									
EL. 1 ANTA da 499 mm - escluso di fianchi e divisioni EL. w/1 DOOR 499 mm - side panels and partitions not included									
<b>308</b>	<b>332</b>	<b>369</b>	<b>434</b>	<b>430</b>	<b>445</b>	<b>448</b>	<b>539</b>	<b>66</b>	
<b>317</b>	<b>340</b>	<b>383</b>	<b>451</b>	<b>447</b>	<b>463</b>	<b>461</b>	<b>549</b>	<b>69</b>	
<b>329</b>	<b>355</b>	<b>400</b>	<b>476</b>	<b>468</b>	<b>489</b>	<b>487</b>	<b>584</b>	<b>71</b>	
<b>356</b>	<b>386</b>	<b>432</b>	<b>516</b>	<b>509</b>	<b>532</b>			<b>78</b>	
EL. 1 ANTA da 621 mm - escluso di fianchi e divisioni EL. w/1 DOOR 621 mm - side panels and partitions not included									
<b>346</b>	<b>374</b>	<b>416</b>	<b>498</b>	<b>487</b>	<b>512</b>	<b>512</b>	<b>625</b>	<b>85</b>	
<b>356</b>	<b>385</b>	<b>433</b>	<b>519</b>	<b>507</b>	<b>535</b>	<b>527</b>	<b>638</b>	<b>88</b>	
<b>371</b>	<b>402</b>	<b>455</b>	<b>548</b>	<b>535</b>	<b>566</b>	<b>557</b>	<b>678</b>	<b>93</b>	
<b>404</b>	<b>440</b>	<b>494</b>	<b>599</b>	<b>584</b>	<b>620</b>			<b>100</b>	
EL. 2 ANTE da 499 mm - escluso di fianchi e divisioni EL. w/2 DOORS 499 mm - side panels and partitions not included									
<b>533</b>	<b>581</b>	<b>655</b>	<b>785</b>	<b>777</b>	<b>807</b>	<b>813</b>	<b>995</b>	<b>140</b>	
<b>552</b>	<b>598</b>	<b>684</b>	<b>820</b>	<b>812</b>	<b>844</b>	<b>840</b>	<b>1.016</b>	<b>143</b>	
<b>574</b>	<b>626</b>	<b>716</b>	<b>868</b>	<b>852</b>	<b>894</b>	<b>890</b>	<b>1.084</b>	<b>149</b>	
<b>629</b>	<b>689</b>	<b>781</b>	<b>949</b>	<b>935</b>	<b>981</b>			<b>161</b>	
EL. 2 ANTE da 621 mm - escluso di fianchi e divisioni EL. w/2 DOORS 621 mm - side panels and partitions not included									
<b>670</b>	<b>726</b>	<b>810</b>	<b>974</b>	<b>952</b>	<b>1.002</b>	<b>1.002</b>	<b>1.228</b>	<b>171</b>	
<b>692</b>	<b>750</b>	<b>846</b>	<b>1.018</b>	<b>994</b>	<b>1.050</b>	<b>1.034</b>	<b>1.256</b>	<b>177</b>	
<b>725</b>	<b>787</b>	<b>893</b>	<b>1.079</b>	<b>1.053</b>	<b>1.115</b>	<b>1.087</b>	<b>1.339</b>	<b>187</b>	
<b>795</b>	<b>867</b>	<b>975</b>	<b>1.185</b>	<b>1.155</b>	<b>1.227</b>			<b>201</b>	

Ulteriori combinazioni di aperture e finiture sono possibili utilizzando le scocche vuote a pag. | Additional finishes and opening combinations are possible using the empty bodies on page 66

# BATTENTE | REGULAR DOOR

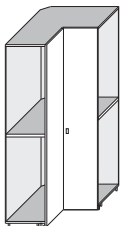
anta con superficie termoformata | door with thermoformed surface

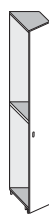
VETRI: cat. 1 sabbia chiara, sabbia scura, corda, grigio pietra, grigio chiaro, grigio medio, grigio polvere, blu piombo, giallo cromo, verde pompelmo, rosso rubino, nero, stopsol fumé, specchio, specchio bronzo, specchio fumo. cat. 2 bianco, magnolia.











- Fianchi e divisioni a pag.   Side panels and partitions on page 24			BASIC	ASOLA	LINEAR	DESIGN	SPRINT	SPRINT PLUS
- Prezzi calcolati con interno melaminico. Dotazione interna vano standard: - N. 1 ripiano - N. 2 tubi appendiabiti - Prices calculated with melamine finish. Standard internal equipment: - 1 shelf - 2 clothes hangers  - Maniglie a pag.   Handles on page 17 - L'anta simply vetro è disponibile solo con maniglia Gamma. The simply vetro door is only available with Gamma handle.  - Maggiorazione per anta Basic, Linear lacc. opaco colore 86 euro. - Surcharge for matt lacq. colour door mod. Basic, Linear euro 86								
			Sezione ante   Door section:					
<b>L. 1104</b>  	H.	CODICE	ANGOLO 2 ANTE da 499 mm - escluso di fianchi e divisioni					
	H.	CODE	CORNER w/2 DOORS 499 mm - side panels and partitions not included					
	2228	EMMA0210	<b>943</b>	<b>969</b>	<b>959</b>		<b>901</b>	<b>921</b>
	2356	EMMA0310	<b>970</b>	<b>997</b>	<b>986</b>		<b>922</b>	<b>944</b>
	2580	EMMA0410	<b>997</b>	<b>1.027</b>	<b>1.016</b>		<b>945</b>	<b>970</b>
	2900	EMMA0610						
<b>L. 421</b>  	H.	CODICE	TERMINALE 1 ANTA da 499 mm - escluso di fianchi e divisioni (a disegno terminale dx, disponibile anche sx)					
	H.	CODE	END UNIT w/1 DOOR 499 mm - side panels and partitions not included (in the drawing, Rh end unit, also available Lh)					
	2228	EMMT0210	<b>313</b>			<b>352</b>	<b>292</b>	<b>312</b>
	2356	EMMT0310	<b>324</b>			<b>365</b>	<b>300</b>	<b>322</b>
	2580	EMMT0410	<b>333</b>			<b>377</b>	<b>307</b>	<b>332</b>
	2900	EMMT0610						

Ulteriori combinazioni di aperture e finiture sono possibili utilizzando le scocche vuote a pag. | Additional finishes and opening combinations are possible using the empty bodies on page 66

# BATTENTE | REGULAR DOOR

## simply

GLASSES: **cat. 1** light sand, dark sand, rope, stone grey, light grey, medium grey, powder grey, gun metal blue, chrome yellow, green grass, ruby red, black, smoke-grey stopsol, mirror, bronze mirror, smoke mirror. **cat. 2** white, magnolia.

SIMPLY lacc. opaco base basic matt lacq.	SIMPLY lacc. opaco colore colour matt lacq.	SIMPLY essenza wood	SIMPLY rovere lacc. poro aperto open pore lacq. oak	SIMPLY rovere termotrattato heat-treated oak	SIMPLY lacc. lucido glossy lacq.	SIMPLY VETRO 1 interno lacc. opaco matt lacq. inside	SIMPLY VETRO 2 interno lacc. opaco matt lacq. inside		Maggiorazione per interno laccato opaco  Increase for matt lacquered inside finish
									

ANGOLO 2 ANTE da 499 mm - escluso di fianchi e divisioni  
CORNER w/2 DOORS 499 mm - side panels and partitions not included

<b>969</b>	<b>1.017</b>	<b>1.091</b>	<b>1.221</b>	<b>1.213</b>	<b>1.243</b>	<b>1.249</b>	<b>1.431</b>	<b>281</b>
<b>994</b>	<b>1.040</b>	<b>1.126</b>	<b>1.262</b>	<b>1.254</b>	<b>1.286</b>	<b>1.282</b>	<b>1.458</b>	<b>288</b>
<b>1.023</b>	<b>1.075</b>	<b>1.165</b>	<b>1.317</b>	<b>1.301</b>	<b>1.343</b>	<b>1.339</b>	<b>1.533</b>	<b>301</b>
<b>1.098</b>	<b>1.158</b>	<b>1.250</b>	<b>1.418</b>	<b>1.404</b>	<b>1.450</b>			<b>327</b>

TERMINALE 1 ANTA da 499 mm - escluso di fianchi e divisioni (a disegno terminale dx, disponibile anche sx)  
END UNIT w/1 DOOR 499 mm - side panels and partitions not included (in the drawing, Rh end unit, also available Lh)

<b>326</b>	<b>350</b>	<b>387</b>	<b>452</b>	<b>448</b>	<b>463</b>	<b>466</b>	<b>557</b>	<b>62</b>
<b>336</b>	<b>359</b>	<b>402</b>	<b>470</b>	<b>466</b>	<b>482</b>	<b>480</b>	<b>568</b>	<b>64</b>
<b>346</b>	<b>372</b>	<b>417</b>	<b>493</b>	<b>485</b>	<b>506</b>	<b>504</b>	<b>601</b>	<b>68</b>
<b>376</b>	<b>406</b>	<b>452</b>	<b>536</b>	<b>529</b>	<b>552</b>			<b>71</b>









Ulteriori combinazioni di aperture e finiture sono possibili utilizzando le scocche vuote a pag. | Additional finishes and opening combinations are possible using the empty bodies on page 66

# BATTENTE | REGULAR DOOR

anta con superficie termoformata | door with thermoformed surface

VETRI: cat. 1 sabbia chiaro, sabbia scuro, corda, grigio pietra, grigio chiaro, grigio medio, grigio polvere, blu piombo, giallo cromo, verde pompelmo, rosso rubino, nero, stopsol fumé, specchio, specchio bronzo, specchio fumo. cat. 2 bianco, magnolia.

- **Attenzione: la finitura dei fianchi segue la finitura dell'anta** (ES: anta essenza - fianco essenza / anta con superficie termoformata o vetro - fianco lacc. opaco base).
- *Attention: the finish of the sides follows the finish of the door* (EX. wooden door - wooden side / door with thermoformed surface or glass - basic matt lacq. side).
- **Prezzi calcolati con interno melaminico.**  
Dotazione interna vano standard: - N. 1 ripiano - N. 2 tubi appendiabiti
- *Prices calculated with melamine finish.*  
Standard internal equipment: - 1 shelf - 2 clothes hangers
- **Maniglie a pag. | Handles on page 17**
- **L'anta simply vetro è disponibile solo con maniglia Gamma.**  
*The simply vetro door is only available with Gamma handle.*
- **Maggiorazione per anta Basic, Linear lacc. opaco colore 86 euro.**
- *Surcharge for matt lacq. colour door mod. Basic, Linear euro 86*



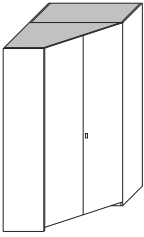
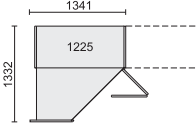
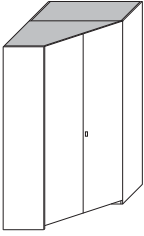
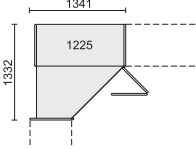
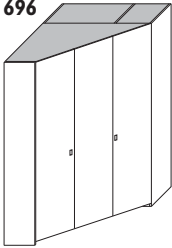
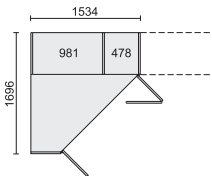







BASIC	ASOLA	LINEAR	DESIGN	SPRINT	SPRINT PLUS
					
<b>Sezione ante   Door section:</b>					

<b>L. 1341 x 1332</b>  	H. H.	CODICE CODE	ANGOLO SPOGLIATOIO - 2 ANTE da 499 mm 1 fianco + 1 divisione (a disegno angolo dx, disponibile anche sx)  WALK-IN CORNER - 2 DOORS 499 mm 1 side panel + 1 partition (in the drawing, Rh corner, also available Lh)					
			2356	SX EMMA1320	<b>1.507</b>		<b>1.589</b>	<b>1.436</b>
				DX EMMA2320	<b>1.507</b>		<b>1.589</b>	<b>1.436</b>
			2580	SX EMMA1420	<b>1.556</b>		<b>1.644</b>	<b>1.481</b>
				DX EMMA2420	<b>1.556</b>		<b>1.644</b>	<b>1.481</b>
			<b>L. 1341 x 1332</b>  	H. H.	CODICE CODE	ANGOLO SPOGLIATOIO - 2 ANTE da 499 mm 2 divisioni (a disegno angolo dx, disponibile anche sx)  WALK-IN CORNER - 2 DOORS 499 mm 2 partitions (in the drawing, Rh corner, also available Lh)		
2356	SX EMMA1321	<b>1.471</b>					<b>1.553</b>	<b>1.423</b>
	DX EMMA2321	<b>1.471</b>					<b>1.553</b>	<b>1.423</b>
2580	SX EMMA1421	<b>1.517</b>					<b>1.605</b>	<b>1.465</b>
	DX EMMA2421	<b>1.517</b>					<b>1.605</b>	<b>1.465</b>
<b>L. 1534 x 1696</b>  	H. H.	CODICE CODE				ANGOLO SPOGLIATOIO - 3 ANTE da 499 mm 1 fianco + 1 divisione (a disegno angolo dx, disponibile anche sx)  WALK-IN CORNER - 3 DOORS 499 mm 1 side panel + 1 partition (in the drawing, Rh corner, also available Lh)		
			2356	SX EMMA1330	<b>1.926</b>		<b>2.049</b>	<b>1.831</b>
				DX EMMA2330	<b>1.926</b>		<b>2.049</b>	<b>1.831</b>
			2580	SX EMMA1430	<b>1.989</b>		<b>2.121</b>	<b>1.891</b>
				DX EMMA2430	<b>1.989</b>		<b>2.121</b>	<b>1.891</b>

# BATTENTE | REGULAR DOOR

simply





GLASSES: **cat. 1** light sand, dark sand, rope, stone grey, light grey, medium grey, powder grey, gun metal blue, chrome yellow, green grass, ruby red, black, smoke-grey stopsol, mirror, bronze mirror, smoke mirror. **cat. 2** white, magnolia.

SIMPLY lacc. opaco base basic matt lacq.	SIMPLY lacc. opaco colore colour matt lacq.	SIMPLY essenza wood	SIMPLY rovere lacc. poro aperto open pore lacq. oak	SIMPLY rovere termotrattato heat-treated oak	SIMPLY lacc. lucido glossy lacq.	SIMPLY VETRO 1 interno lacc. opaco matt lacq. inside	SIMPLY VETRO 2 interno lacc. opaco matt lacq. inside		Maggiorazione per interno laccato opaco  Increase for matt lacquered inside finish
									
<p>ANGOLO SPOGLIATOIO - 2 ANTE da 499 mm 1 fianco + 1 divisione (a disegno angolo dx, disponibile anche sx)</p> <p>WALK-IN CORNER - 2 DOORS 499 mm 1 side panel + 1 partition (in the drawing, Rh corner, also available Lh)</p>									
<b>1.531</b>	<b>1.589</b>	<b>1.704</b>	<b>1.884</b>	<b>1.893</b>	<b>1.903</b>	<b>1.819</b>	<b>1.995</b>		<b>434</b>
<b>1.531</b>	<b>1.589</b>	<b>1.704</b>	<b>1.884</b>	<b>1.893</b>	<b>1.903</b>	<b>1.819</b>	<b>1.995</b>		<b>434</b>
<b>1.582</b>	<b>1.647</b>	<b>1.769</b>	<b>1.969</b>	<b>1.969</b>	<b>1.990</b>	<b>1.898</b>	<b>2.092</b>		<b>463</b>
<b>1.582</b>	<b>1.647</b>	<b>1.769</b>	<b>1.969</b>	<b>1.969</b>	<b>1.990</b>	<b>1.898</b>	<b>2.092</b>		<b>463</b>
<p>ANGOLO SPOGLIATOIO - 2 ANTE da 499 mm 2 divisioni (a disegno angolo dx, disponibile anche sx)</p> <p>WALK-IN CORNER - 2 DOORS 499 mm 2 partitions (in the drawing, Rh corner, also available Lh)</p>									
<b>1.495</b>	<b>1.541</b>	<b>1.627</b>	<b>1.763</b>	<b>1.755</b>	<b>1.787</b>	<b>1.783</b>	<b>1.959</b>		<b>471</b>
<b>1.495</b>	<b>1.541</b>	<b>1.627</b>	<b>1.763</b>	<b>1.755</b>	<b>1.787</b>	<b>1.783</b>	<b>1.959</b>		<b>471</b>
<b>1.543</b>	<b>1.595</b>	<b>1.685</b>	<b>1.837</b>	<b>1.821</b>	<b>1.863</b>	<b>1.859</b>	<b>2.053</b>		<b>505</b>
<b>1.543</b>	<b>1.595</b>	<b>1.685</b>	<b>1.837</b>	<b>1.821</b>	<b>1.863</b>	<b>1.859</b>	<b>2.053</b>		<b>505</b>
<p>ANGOLO SPOGLIATOIO - 3 ANTE da 499 mm 1 fianco + 1 divisione (a disegno angolo dx, disponibile anche sx)</p> <p>WALK-IN CORNER - 3 DOORS 499 mm 1 side panel + 1 partition (in the drawing, Rh corner, also available Lh)</p>									
<b>1.962</b>	<b>2.043</b>	<b>2.199</b>	<b>2.446</b>	<b>2.450</b>	<b>2.477</b>	<b>2.394</b>	<b>2.658</b>		<b>584</b>
<b>1.962</b>	<b>2.043</b>	<b>2.199</b>	<b>2.446</b>	<b>2.450</b>	<b>2.477</b>	<b>2.394</b>	<b>2.658</b>		<b>584</b>
<b>2.028</b>	<b>2.119</b>	<b>2.285</b>	<b>2.560</b>	<b>2.551</b>	<b>2.594</b>	<b>2.502</b>	<b>2.793</b>		<b>625</b>
<b>2.028</b>	<b>2.119</b>	<b>2.285</b>	<b>2.560</b>	<b>2.551</b>	<b>2.594</b>	<b>2.502</b>	<b>2.793</b>		<b>625</b>

# BATTENTE | REGULAR DOOR

anta con superficie termoformata | door with thermoformed surface

VERTRI: cat. 1 sabbia chiaro, sabbia scuro, corda, grigio pietra, grigio chiaro, grigio medio, grigio polvere, blu piombo, giallo cromo, verde pompelmo, rosso rubino, nero, stopsol fumé, specchio, specchio bronzo, specchio fumo. cat. 2 bianco, magnolia.

<p>- <b>Attenzione: la finitura dei fianchi segue la finitura dell'anta</b> (ES: anta essenza - fianco essenza / anta con superficie termoformata o vetro - fianco lacc. opaco base).</p> <p>- <b>Attention: the finish of the sides follows the finish of the door</b> (EX: wooden door - wooden side / door with thermoformed surface or glass - basic matt lacq. side).</p> <p>- <b>Prezzi calcolati con interno melaminico.</b> Dotazione interna vano standard: - N. 1 ripiano - N. 2 tubi appendiabiti</p> <p>- <b>Prices calculated with melamine finish.</b> Standard internal equipment: - 1 shelf - 2 clothes hangers</p> <p>- <b>Maniglie a pag.   Handles on page 17</b></p> <p>- <b>L'anta simply vetro è disponibile solo con maniglia Gamma.</b> The simply vetro door is only available with Gamma handle.</p> <p>- <b>Maggiorazione per anta Basic, Linear lacc. opaco colore 86 euro.</b> - <b>Surcharge for matt lacq. colour door mod. Basic, Linear euro 86</b></p>	BASIC	ASOLA	LINEAR	DESIGN	SPRINT	SPRINT PLUS
						

Sezione ante | Door section:

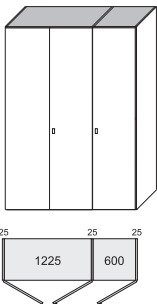
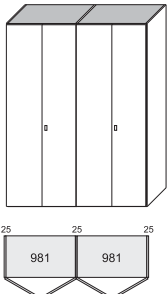
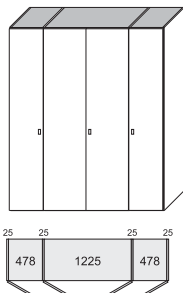

L. 1534	H. H.	CODICE CODE	EL. 3 ANTE da 499 mm EL. w/3 DOORS 499 mm						
		2228 EMAB2130		<b>1.105</b>	<b>1.157</b>	<b>1.137</b>	<b>1.222</b>	<b>1.020</b>	<b>1.060</b>
		2356 EMAB3130		<b>1.147</b>	<b>1.201</b>	<b>1.179</b>	<b>1.270</b>	<b>1.051</b>	<b>1.095</b>
		2580 EMAB4130		<b>1.200</b>	<b>1.260</b>	<b>1.238</b>	<b>1.332</b>	<b>1.092</b>	<b>1.142</b>
		2900 EMAB6130							
L. 1900	H. H.	CODICE CODE	EL. 3 ANTE da 621 mm EL. w/3 DOORS 621 mm						
		2228 EMAB2160						<b>1.165</b>	<b>1.205</b>
		2356 EMAB3160						<b>1.203</b>	<b>1.249</b>
		2580 EMAB4160						<b>1.252</b>	<b>1.302</b>
		2900 EMAB6160							
L. 2037	H. H.	CODICE CODE	EL. 4 ANTE da 499 mm EL. w/4 DOORS 499 mm						
		2228 EMAB2200		<b>1.317</b>	<b>1.369</b>	<b>1.349</b>	<b>1.473</b>	<b>1.211</b>	<b>1.251</b>
		2356 EMAB3200		<b>1.370</b>	<b>1.424</b>	<b>1.402</b>	<b>1.534</b>	<b>1.250</b>	<b>1.294</b>
		2580 EMAB4200		<b>1.432</b>	<b>1.492</b>	<b>1.470</b>	<b>1.608</b>	<b>1.298</b>	<b>1.348</b>
		2900 EMAB6200							
L. 2281	H. H.	CODICE CODE	EL. 4 ANTE da 499-621 mm EL. w/4 DOORS 499-621 mm						
		2228 EMAB2210						<b>1.492</b>	<b>1.552</b>
		2356 EMAB3210						<b>1.538</b>	<b>1.605</b>
		2580 EMAB4210						<b>1.599</b>	<b>1.674</b>
		2900 EMAB6210							











Ulteriori combinazioni di aperture e finiture sono possibili utilizzando le scocche vuote a pag. | Additional finishes and opening combinations are possible using the empty bodies on page 66



# BATTENTE | REGULAR DOOR

simply

GLASSES: **cat. 1** light sand, dark sand, rope, stone grey, light grey, medium grey, powder grey, gun metal blue, chrome yellow, green grass, ruby red, black, smoke-grey stopsol, mirror, bronze mirror, smoke mirror. **cat. 2** white, magnolia.

<b>SIMPLY</b> lacc. opaco base <i>basic matt lacq.</i>	<b>SIMPLY</b> lacc. opaco colore <i>colour matt lacq.</i>	<b>SIMPLY</b> essenza <i>wood</i>	<b>SIMPLY</b> rovere lacc. poro aperto <i>open pore lacq. oak</i>	<b>SIMPLY</b> rovere termotrattato <i>heat-treated oak</i>	<b>SIMPLY</b> lacc. lucido <i>glossy lacq.</i>	<b>SIMPLY VETRO 1</b> interno lacc. opaco <i>matt lacq. inside</i>	<b>SIMPLY VETRO 2</b> interno lacc. opaco <i>matt lacq. inside</i>		Maggiorazione per interno laccato opaco  <i>Increase for matt lacquered inside finish</i>
									
EL. 3 ANTE da 499 mm <i>EL. w/3 DOORS 499 mm</i>									
<b>1.144</b>	<b>1.242</b>	<b>1.417</b>	<b>1.694</b>	<b>1.668</b>	<b>1.725</b>	<b>1.564</b>	<b>1.837</b>		<b>365</b>
<b>1.183</b>	<b>1.280</b>	<b>1.475</b>	<b>1.767</b>	<b>1.743</b>	<b>1.801</b>	<b>1.615</b>	<b>1.879</b>		<b>381</b>
<b>1.239</b>	<b>1.343</b>	<b>1.552</b>	<b>1.876</b>	<b>1.834</b>	<b>1.913</b>	<b>1.713</b>	<b>2.004</b>		<b>406</b>
<b>1.363</b>	<b>1.487</b>	<b>1.701</b>	<b>2.063</b>	<b>2.020</b>	<b>2.111</b>				<b>443</b>
EL. 3 ANTE da 621 mm <i>EL. w/3 DOORS 621 mm</i>									
<b>1.319</b>	<b>1.429</b>	<b>1.619</b>	<b>1.947</b>	<b>1.900</b>	<b>1.987</b>	<b>1.817</b>	<b>2.156</b>		<b>415</b>
<b>1.362</b>	<b>1.477</b>	<b>1.687</b>	<b>2.033</b>	<b>1.985</b>	<b>2.079</b>	<b>1.875</b>	<b>2.208</b>		<b>434</b>
<b>1.432</b>	<b>1.551</b>	<b>1.784</b>	<b>2.159</b>	<b>2.102</b>	<b>2.211</b>	<b>1.990</b>	<b>2.353</b>		<b>466</b>
<b>1.577</b>	<b>1.719</b>	<b>1.957</b>	<b>2.382</b>	<b>2.315</b>	<b>2.445</b>				<b>505</b>
EL. 4 ANTE da 499 mm <i>EL. w/4 DOORS 499 mm</i>									
<b>1.369</b>	<b>1.491</b>	<b>1.703</b>	<b>2.045</b>	<b>2.015</b>	<b>2.087</b>	<b>1.929</b>	<b>2.293</b>		<b>439</b>
<b>1.418</b>	<b>1.538</b>	<b>1.776</b>	<b>2.136</b>	<b>2.108</b>	<b>2.182</b>	<b>1.994</b>	<b>2.346</b>		<b>455</b>
<b>1.484</b>	<b>1.614</b>	<b>1.868</b>	<b>2.268</b>	<b>2.218</b>	<b>2.318</b>	<b>2.116</b>	<b>2.504</b>		<b>484</b>
<b>1.636</b>	<b>1.790</b>	<b>2.050</b>	<b>2.496</b>	<b>2.446</b>	<b>2.560</b>				<b>526</b>
EL. 4 ANTE da 499-621 mm <i>EL. w/4 DOORS 499-621 mm</i>									
<b>1.670</b>	<b>1.800</b>	<b>2.022</b>	<b>2.398</b>	<b>2.354</b>	<b>2.446</b>	<b>2.282</b>	<b>2.690</b>		<b>539</b>
<b>1.724</b>	<b>1.856</b>	<b>2.104</b>	<b>2.500</b>	<b>2.456</b>	<b>2.554</b>	<b>2.354</b>	<b>2.752</b>		<b>565</b>
<b>1.807</b>	<b>1.947</b>	<b>2.217</b>	<b>2.651</b>	<b>2.591</b>	<b>2.711</b>	<b>2.495</b>	<b>2.931</b>		<b>605</b>
<b>1.985</b>	<b>2.151</b>	<b>2.427</b>	<b>2.915</b>	<b>2.849</b>	<b>2.989</b>				<b>657</b>

Ulteriori combinazioni di aperture e finiture sono possibili utilizzando le scocche vuote a pag. | Additional finishes and opening combinations are possible using the empty bodies on page 66

# BATTENTE | REGULAR DOOR

anta con superficie termoformata | door with thermoformed surface

VETRI: cat. 1 sabbia chiaro, sabbia scuro, corda, grigio pietra, grigio chiaro, grigio medio, grigio polvere, blu piombo, giallo cromo, verde pompelmo, rosso rubino, nero, stopsol fumé, specchio, specchio bronzo, specchio fumo. cat. 2 bianco, magnolia.

<ul style="list-style-type: none"> <li>- <b>Attenzione: la finitura dei fianchi segue la finitura dell'anta (ES: anta essenza - fianco essenza / anta con superficie termoformata o vetro - fianco lacc. opaco base).</b></li> <li>- <i>Attention: the finish of the sides follows the finish of the door (EX. wooden door - wooden side / door with thermoformed surface or glass - basic matt lacq. side).</i></li> <li>- <b>Prezzi calcolati con interno melaminico.</b></li> <li>- <i>Prices calculated with melamine finish.</i></li> <li>- <b>Dotazione interna vano standard: - N. 1 ripiano - N. 2 tubi appendiabiti</b></li> <li>- <i>Standard internal equipment: - 1 shelf - 2 clothes hangers</i></li> <li>- <b>Maniglie a pag.   Handles on page 17</b></li> <li>- <b>L'anta simply vetro è disponibile solo con maniglia Gamma.</b></li> <li>- <i>The simply vetro door is only available with Gamma handle.</i></li> <li>- <b>Maggiorazione per anta Basic, Linear lacc. opaco colore 86 euro.</b></li> <li>- <i>Surcharge for matt lacq. colour door mod. Basic, Linear euro 86</i></li> </ul>	BASIC	ASOLA	LINEAR	DESIGN	SPRINT	SPRINT PLUS
	<p><b>Sezione ante   Door section:</b></p>					

<b>L. 2525</b>  	H.	CODICE	EL. 4 ANTE da 621 mm EL. w/4 DOORS 621 mm					
	H.	CODE						
	2228	EMAB2230					<b>1.445</b>	<b>1.485</b>
	2356	EMAB3230					<b>1.494</b>	<b>1.540</b>
	2580	EMAB4230					<b>1.556</b>	<b>1.606</b>
2900	EMAB6230							

<b>L. 2540</b>  	H.	CODICE	EL. 5 ANTE da 499 mm EL. w/5 DOORS 499 mm					
	H.	CODE						
	2228	EMAB2240	<b>1.693</b>	<b>1.771</b>	<b>1.741</b>	<b>1.888</b>	<b>1.566</b>	<b>1.626</b>
	2356	EMAB3240	<b>1.759</b>	<b>1.840</b>	<b>1.807</b>	<b>1.964</b>	<b>1.615</b>	<b>1.681</b>
	2580	EMAB4240	<b>1.836</b>	<b>1.926</b>	<b>1.893</b>	<b>2.056</b>	<b>1.676</b>	<b>1.751</b>
2900	EMAB6240							

<b>L. 3150</b>  	H.	CODICE	EL. 5 ANTE da 621 mm EL. w/5 DOORS 621 mm					
	H.	CODE						
	2228	EMAB2310					<b>1.828</b>	<b>1.888</b>
	2356	EMAB3310					<b>1.889</b>	<b>1.958</b>
	2580	EMAB4310					<b>1.965</b>	<b>2.040</b>
2900	EMAB6310							











<b>L. 3043</b>  	H.	CODICE	EL. 6 ANTE da 499 mm EL. w/6 DOORS 499 mm					
	H.	CODE						
	2228	EMAB2300	<b>1.905</b>	<b>1.983</b>	<b>1.953</b>	<b>2.139</b>	<b>1.757</b>	<b>1.817</b>
	2356	EMAB3300	<b>1.982</b>	<b>2.063</b>	<b>2.030</b>	<b>2.228</b>	<b>1.814</b>	<b>1.880</b>
	2580	EMAB4300	<b>2.068</b>	<b>2.158</b>	<b>2.125</b>	<b>2.332</b>	<b>1.882</b>	<b>1.957</b>
2900	EMAB6300							

Ulteriori combinazioni di aperture e finiture sono possibili utilizzando le scocche vuote a pag. | Additional finishes and opening combinations are possible using the empty bodies on page 66

# BATTENTE | REGULAR DOOR

simply

GLASSES: cat. 1 light sand, dark sand, rope, stone grey, light grey, medium grey, powder grey, gun metal blue, chrome yellow, green grass, ruby red, black, smoke-grey stopsol, mirror, bronze mirror, smoke mirror. cat. 2 white, magnolia.

SIMPLY lacc. opaco base basic matt lacq.	SIMPLY lacc. opaco colore colour matt lacq.	SIMPLY essenza wood	SIMPLY rovere lacc. poro aperto open pore lacq. oak	SIMPLY rovere termotrattato heat-treated oak	SIMPLY lacc. lucido glossy lacq.	SIMPLY VETRO 1 interno lacc. opaco matt lacq. inside	SIMPLY VETRO 2 interno lacc. opaco matt lacq. inside		Maggiorazione per interno laccato opaco  Increase for matt lacquered inside finish
									
EL. 4 ANTE da 621 mm EL. w/4 DOORS 621 mm									
<b>1.643</b>	<b>1.781</b>	<b>2.013</b>	<b>2.423</b>	<b>2.365</b>	<b>2.477</b>	<b>2.307</b>	<b>2.759</b>		<b>501</b>
<b>1.698</b>	<b>1.842</b>	<b>2.100</b>	<b>2.532</b>	<b>2.472</b>	<b>2.594</b>	<b>2.382</b>	<b>2.826</b>		<b>523</b>
<b>1.786</b>	<b>1.936</b>	<b>2.222</b>	<b>2.690</b>	<b>2.620</b>	<b>2.760</b>	<b>2.530</b>	<b>3.014</b>		<b>560</b>
<b>1.968</b>	<b>2.146</b>	<b>2.438</b>	<b>2.968</b>	<b>2.886</b>	<b>3.052</b>				<b>606</b>
EL. 5 ANTE da 499 mm EL. w/5 DOORS 499 mm									
<b>1.758</b>	<b>1.904</b>	<b>2.153</b>	<b>2.560</b>	<b>2.526</b>	<b>2.613</b>	<b>2.458</b>	<b>2.913</b>		<b>582</b>
<b>1.819</b>	<b>1.962</b>	<b>2.243</b>	<b>2.671</b>	<b>2.639</b>	<b>2.729</b>	<b>2.539</b>	<b>2.979</b>		<b>605</b>
<b>1.901</b>	<b>2.057</b>	<b>2.356</b>	<b>2.832</b>	<b>2.774</b>	<b>2.895</b>	<b>2.691</b>	<b>3.176</b>		<b>645</b>
<b>2.092</b>	<b>2.276</b>	<b>2.582</b>	<b>3.112</b>	<b>3.055</b>	<b>3.192</b>				<b>700</b>
EL. 5 ANTE da 621 mm EL. w/5 DOORS 621 mm									
<b>2.070</b>	<b>2.236</b>	<b>2.510</b>	<b>3.002</b>	<b>2.933</b>	<b>3.070</b>	<b>2.900</b>	<b>3.465</b>		<b>663</b>
<b>2.138</b>	<b>2.311</b>	<b>2.617</b>	<b>3.135</b>	<b>3.063</b>	<b>3.213</b>	<b>2.993</b>	<b>3.548</b>		<b>692</b>
<b>2.245</b>	<b>2.426</b>	<b>2.765</b>	<b>3.326</b>	<b>3.243</b>	<b>3.414</b>	<b>3.175</b>	<b>3.780</b>		<b>743</b>
<b>2.472</b>	<b>2.686</b>	<b>3.032</b>	<b>3.667</b>	<b>3.570</b>	<b>3.772</b>				<b>802</b>
EL. 6 ANTE da 499 mm EL. w/6 DOORS 499 mm									
<b>1.983</b>	<b>2.153</b>	<b>2.439</b>	<b>2.911</b>	<b>2.873</b>	<b>2.975</b>	<b>2.823</b>	<b>3.369</b>		<b>656</b>
<b>2.054</b>	<b>2.220</b>	<b>2.544</b>	<b>3.040</b>	<b>3.004</b>	<b>3.110</b>	<b>2.918</b>	<b>3.446</b>		<b>679</b>
<b>2.146</b>	<b>2.328</b>	<b>2.672</b>	<b>3.224</b>	<b>3.158</b>	<b>3.300</b>	<b>3.094</b>	<b>3.676</b>		<b>723</b>
<b>2.365</b>	<b>2.579</b>	<b>2.931</b>	<b>3.545</b>	<b>3.481</b>	<b>3.641</b>				<b>783</b>









Ulteriori combinazioni di aperture e finiture sono possibili utilizzando le scocche vuote a pag. | Additional finishes and opening combinations are possible using the empty bodies on page 66

# BATTENTE | REGULAR DOOR

anta con superficie termoformata | door with thermoformed surface

VETRI: cat. 1 sabbia chiara, sabbia scura, corda, grigio pietra, grigio chiaro, grigio medio, grigio polvere, blu piombo, giallo cromo, verde pompelmo, rosso rubino, nero, stopsol fumé, specchio, specchio bronzo, specchio fumo. cat. 2 bianco, magnolia.

- **Attenzione: la finitura dei fianchi segue la finitura dell'anta** (ES: anta essenza - fianco essenza / anta con superficie termoformata o vetro - fianco lacc. opaco base).
- *Attention: the finish of the sides follows the finish of the door* (EX. wooden door - wooden side / door with thermoformed surface or glass - basic matt lacq. side).
- **Prezzi calcolati con interno melaminico.**  
Dotazione interna vano standard: - N. 1 ripiano - N. 2 tubi appendiabiti
- *Prices calculated with melamine finish.*  
Standard internal equipment: - 1 shelf - 2 clothes hangers
- **Maniglie a pag. | Handles on page 17**
- **L'anta simply vetro è disponibile solo con maniglia Gamma.**  
*The simply vetro door is only available with Gamma handle.*
- **Maggiorazione per anta Basic, Linear lacc. opaco colore 86 euro.**  
*Surcharge for matt lacq. colour door mod. Basic, Linear euro 86*

BASIC	ASOLA	LINEAR	DESIGN	SPRINT	SPRINT PLUS	
						
Sezione ante   Door section:						

## L. 3287

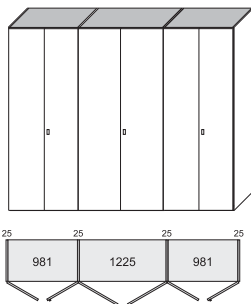

H.  
H.

CODICE  
CODE

EL. 6 ANTE da 499-621 mm  
EL. w/6 DOORS 499-621 mm

2228	EMAB2320				<b>1.874</b>	<b>1.934</b>
2356	EMAB3320				<b>1.936</b>	<b>2.003</b>
2580	EMAB4320				<b>2.011</b>	<b>2.086</b>
2900	EMAB6320					

## L. 3531

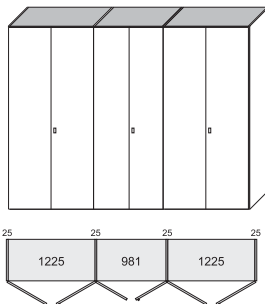

H.  
H.

CODICE  
CODE

EL. 6 ANTE da 499-621 mm  
EL. w/6 DOORS 499-621 mm

2228	EMAB2330				<b>1.991</b>	<b>2.051</b>
2356	EMAB3330				<b>2.058</b>	<b>2.126</b>
2580	EMAB4330				<b>2.140</b>	<b>2.215</b>
2900	EMAB6330					

## L. 3775

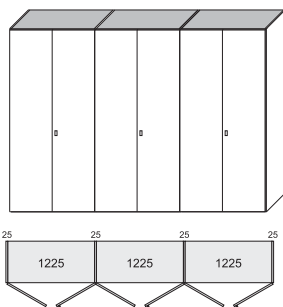

H.  
H.

CODICE  
CODE

EL. 6 ANTE da 621 mm  
EL. w/6 DOORS 621 mm

2228	EMAB2360				<b>2.108</b>	<b>2.168</b>
2356	EMAB3360				<b>2.180</b>	<b>2.249</b>
2580	EMAB4360				<b>2.269</b>	<b>2.344</b>
2900	EMAB6360					

## L. 4049

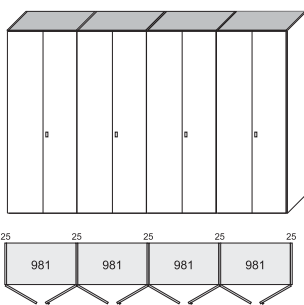

H.  
H.

CODICE  
CODE

EL. 8 ANTE da 499 mm  
EL. w/8 DOORS 499 mm

2228	EMAB2400	<b>2.493</b>	<b>2.597</b>	<b>2.557</b>	<b>2.805</b>	<b>2.303</b>	<b>2.383</b>
2356	EMAB3400	<b>2.594</b>	<b>2.702</b>	<b>2.658</b>	<b>2.922</b>	<b>2.378</b>	<b>2.466</b>
2580	EMAB4400	<b>2.704</b>	<b>2.824</b>	<b>2.780</b>	<b>3.056</b>	<b>2.466</b>	<b>2.566</b>
2900	EMAB6400						

Ulteriori combinazioni di aperture e finiture sono possibili utilizzando le scocche vuote a pag. | Additional finishes and opening combinations are possible using the empty bodies on page 66

# BATTENTE | REGULAR DOOR

simply

GLASSES: **cat. 1** light sand, dark sand, rope, stone grey, light grey, medium grey, powder grey, gun metal blue, chrome yellow, green grass, ruby red, black, smoke-grey stopsol, mirror, bronze mirror, smoke mirror. **cat. 2** white, magnolia.

SIMPLY lacc. opaco base basic matt lacq.		SIMPLY lacc. opaco colore colour matt lacq.		SIMPLY essenza wood		SIMPLY rovere lacc. poro aperto open pore lacq. oak		SIMPLY rovere termotrattato heat-treated oak		SIMPLY lacc. lucido glossy lacq.		SIMPLY VETRO 1 interno lacc. opaco matt lacq. inside		SIMPLY VETRO 2 interno lacc. opaco matt lacq. inside		Maggiorazione per interno laccato opaco  Increase for matt lacquered inside finish
EL. 6 ANTE da 499-621 mm EL. w/6 DOORS 499-621 mm																
<b>2.120</b>	<b>2.298</b>	<b>2.594</b>	<b>3.100</b>	<b>3.048</b>	<b>3.170</b>	<b>3.012</b>	<b>3.602</b>									<b>687</b>
<b>2.194</b>	<b>2.372</b>	<b>2.706</b>	<b>3.238</b>	<b>3.186</b>	<b>3.316</b>	<b>3.112</b>	<b>3.686</b>									<b>713</b>
<b>2.297</b>	<b>2.489</b>	<b>2.849</b>	<b>3.435</b>	<b>3.359</b>	<b>3.521</b>	<b>3.301</b>	<b>3.931</b>									<b>761</b>
<b>2.531</b>	<b>2.757</b>	<b>3.125</b>	<b>3.781</b>	<b>3.701</b>	<b>3.887</b>											<b>823</b>
EL. 6 ANTE da 499-621 mm EL. w/6 DOORS 499-621 mm																
<b>2.257</b>	<b>2.443</b>	<b>2.749</b>	<b>3.289</b>	<b>3.223</b>	<b>3.365</b>	<b>3.201</b>	<b>3.835</b>									<b>718</b>
<b>2.334</b>	<b>2.524</b>	<b>2.868</b>	<b>3.436</b>	<b>3.368</b>	<b>3.522</b>	<b>3.306</b>	<b>3.926</b>									<b>747</b>
<b>2.448</b>	<b>2.650</b>	<b>3.026</b>	<b>3.646</b>	<b>3.560</b>	<b>3.742</b>	<b>3.508</b>	<b>4.186</b>									<b>799</b>
<b>2.697</b>	<b>2.935</b>	<b>3.319</b>	<b>4.017</b>	<b>3.921</b>	<b>4.133</b>											<b>863</b>
EL. 6 ANTE da 621 mm EL. w/6 DOORS 621 mm																
<b>2.394</b>	<b>2.588</b>	<b>2.904</b>	<b>3.478</b>	<b>3.398</b>	<b>3.560</b>	<b>3.390</b>	<b>4.068</b>									<b>749</b>
<b>2.474</b>	<b>2.676</b>	<b>3.030</b>	<b>3.634</b>	<b>3.550</b>	<b>3.728</b>	<b>3.500</b>	<b>4.166</b>									<b>781</b>
<b>2.599</b>	<b>2.811</b>	<b>3.203</b>	<b>3.857</b>	<b>3.761</b>	<b>3.963</b>	<b>3.715</b>	<b>4.441</b>									<b>837</b>
<b>2.863</b>	<b>3.113</b>	<b>3.513</b>	<b>4.253</b>	<b>4.141</b>	<b>4.379</b>											<b>903</b>
EL. 8 ANTE da 499 mm EL. w/8 DOORS 499 mm																
<b>2.597</b>	<b>2.815</b>	<b>3.175</b>	<b>3.777</b>	<b>3.731</b>	<b>3.863</b>	<b>3.717</b>	<b>4.445</b>									<b>873</b>
<b>2.690</b>	<b>2.902</b>	<b>3.312</b>	<b>3.944</b>	<b>3.900</b>	<b>4.038</b>	<b>3.842</b>	<b>4.546</b>									<b>903</b>
<b>2.808</b>	<b>3.042</b>	<b>3.476</b>	<b>4.180</b>	<b>4.098</b>	<b>4.282</b>	<b>4.072</b>	<b>4.848</b>									<b>962</b>
<b>3.094</b>	<b>3.368</b>	<b>3.812</b>	<b>4.594</b>	<b>4.516</b>	<b>4.722</b>											<b>1.040</b>

Ulteriori combinazioni di aperture e finiture sono possibili utilizzando le scocche vuote a pag. | Additional finishes and opening combinations are possible using the empty bodies on page 66

# BATTENTE | REGULAR DOOR

tecno

NETTI: cat. 1 sabbia chiara, sabbia scura, corda, grigio pietra, grigio chiaro, grigio medio, grigio polvere, blu piombo, giallo cromo, verde pompelmo, rosso rubino, nero, stopsol fumé, specchio, specchio bronzo, specchio fumo. cat. 2 bianco, magnolia.

- Fianchi e divisioni a pag. | Side panels and partitions on page 24

- Prezzi calcolati con interno melaminico.

Dotazione interna vano standard: - N. 1 ripiano - N. 2 tubi appendiabiti

- Prices calculated with melamine finish.

Standard internal equipment: - 1 shelf - 2 clothes hangers

- Maniglia inserita per tutta la lunghezza dell'anta: disponibile in finitura bianco, con maggiorazione di 30 euro per la finitura brill spazzolato e laccato opaco colore (da specificare nell'ordine).

- Handle built-in along the length of the door, available in white finish, with increase of 30 euros for the brushed brill finish and matt lacquer colour (to be specified in the order).

TECNO lacc. opaco base basic matt lacq.	TECNO lacc. opaco colore colour matt lacq.	TECNO essenza wood	TECNO rovere lacc. poro aperto open pore lacq. oak	TECNO rovere termotrattato heat-treated oak	TECNO lacc. lucido glossy lacq.

Sezione ante | Door section:





L. 478		H. H.	CODICE CODE	EL. 1 ANTA da 499 mm - escluso di fianchi e divisioni EL. w/1 DOOR 499 mm - side panels and partitions not included					
				355	383	424	488	479	514
			2228 EMMB0220	355	383	424	488	479	514
			2356 EMMB0320	364	388	439	506	497	529
			2580 EMMB0420	377	405	459	532	520	556
			2900 EMMB0620	409	440	501	585	571	612
L. 600		H. H.	CODICE CODE	EL. 1 ANTA da 621 mm - escluso di fianchi e divisioni EL. w/1 DOOR 621 mm - side panels and partitions not included					
				392	420	470	546	532	574
			2228 EMMB0230	392	420	470	546	532	574
			2356 EMMB0330	403	433	490	570	556	601
			2580 EMMB0430	419	451	511	599	581	632
			2900 EMMB0630	456	493	561	661	640	699
L. 981		H. H.	CODICE CODE	EL. 2 ANTE da 499 mm - escluso di fianchi e divisioni EL. w/2 DOORS 499 mm - side panels and partitions not included					
				580	632	710	839	826	876
			2228 EMMB0250	580	632	710	839	826	876
			2356 EMMB0350	599	646	740	875	862	910
			2580 EMMB0450	622	676	775	924	904	961
			2900 EMMB0650	682	743	850	1.018	997	1.061
L. 1225		H. H.	CODICE CODE	EL. 2 ANTE da 621 mm - escluso di fianchi e divisioni EL. w/2 DOORS 621 mm - side panels and partitions not included					
				716	772	864	1.022	997	1.064
			2228 EMMB0260	716	772	864	1.022	997	1.064
			2356 EMMB0360	739	798	903	1.069	1.043	1.116
			2580 EMMB0460	773	836	949	1.130	1.099	1.181
			2900 EMMB0660	847	920	1.042	1.247	1.211	1.306

Ulteriori combinazioni di aperture e finiture sono possibili utilizzando le scocche vuote a pag. | Additional finishes and opening combinations are possible using the empty bodies on page 66

# BATTENTE | REGULAR DOOR

## tecno vetro

GLASSES: **cat. 1** light sand, dark sand, rope, stone grey, light grey, medium grey, powder grey, gun metal blue, chrome yellow, green grass, ruby red, black, smoke-grey stopsol, mirror, bronze mirror, smoke mirror. **cat. 2** white, magnolia.

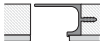
<b>TECNO VETRO 1</b> interno lacc. opaco matt lacq. inside		<b>TECNO VETRO 2</b> interno lacc. opaco matt lacq. inside							Maggiorazione per interno laccato opaco  <i>Increase                      for matt lacquered                      inside finish</i>
									
									
EL. 1 ANTA da 499 mm - escluso di fianchi e divisioni EL. w/1 DOOR 499 mm - side panels and partitions not included									
<b>490</b>	<b>574</b>							<b>66</b>	
<b>503</b>	<b>582</b>							<b>69</b>	
<b>529</b>	<b>616</b>							<b>71</b>	
								<b>78</b>	
EL. 1 ANTA da 621 mm - escluso di fianchi e divisioni EL. w/1 DOOR 621 mm - side panels and partitions not included									
<b>552</b>	<b>657</b>							<b>85</b>	
<b>568</b>	<b>669</b>							<b>88</b>	
<b>598</b>	<b>708</b>							<b>93</b>	
								<b>100</b>	
EL. 2 ANTE da 499 mm - escluso di fianchi e divisioni EL. w/2 DOORS 499 mm - side panels and partitions not included									
<b>855</b>	<b>1.030</b>							<b>140</b>	
<b>882</b>	<b>1.049</b>							<b>143</b>	
<b>932</b>	<b>1.116</b>							<b>149</b>	
								<b>161</b>	
EL. 2 ANTE da 621 mm - escluso di fianchi e divisioni EL. w/2 DOORS 621 mm - side panels and partitions not included									
<b>1.042</b>	<b>1.260</b>							<b>171</b>	
<b>1.075</b>	<b>1.287</b>							<b>177</b>	
<b>1.138</b>	<b>1.369</b>							<b>187</b>	
								<b>201</b>	

Ulteriori combinazioni di aperture e finiture sono possibili utilizzando le scocche vuote a pag. | Additional finishes and opening combinations are possible using the empty bodies on page 66

# BATTENTE | REGULAR DOOR

tecno

VETRI: cat. 1 sabbia chiaro, sabbia scuro, corda, grigio pietra, grigio chiaro, grigio medio, grigio polvere, blu piombo, giallo cromo, verde pompelmo, rosso rubino, nero, stopsol fumé, specchio, specchio bronzo, specchio fumo. cat. 2 bianco, magnolia.

- Fianchi e divisioni a pag. | Side panels and partitions on page 24

- Prezzi calcolati con interno melaminico.

Dotazione interna vano standard: - N. 1 ripiano - N. 2 tubi appendiabiti

- Prices calculated with melamine finish.

Standard internal equipment: - 1 shelf - 2 clothes hangers

- Maniglia inserita per tutta la lunghezza dell'anta: disponibile in finitura bianco, con maggiorazione di 30 euro per la finitura brill spazzolato e laccato opaco colore (da specificare nell'ordine).

- Handle built-in along the length of the door, available in white finish, with increase of 30 euros for the brushed brill finish and matt lacquer colour (to be specified in the order).

TECNO lacc. opaco base basic matt lacq.	TECNO lacc. opaco colore colour matt lacq.	TECNO essenza wood	TECNO rovere lacc. poro aperto open pore lacq. oak	TECNO rovere termotrattato heat-treated oak	TECNO lacc. lucido glossy lacq.

Sezione ante | Door section:



L. 1104

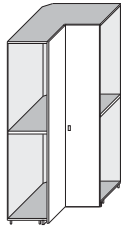

H.  
H.

CODICE  
CODE

ANGOLO 2 ANTE da 499 mm - escluso di fianchi e divisioni  
CORNER w/2 DOORS 499 mm - side panels and partitions not included

2228	EMMA0210	1.016	1.068	1.146	1.275	1.262	1.312
2356	EMMA0310	1.041	1.088	1.182	1.317	1.304	1.352
2580	EMMA0410	1.071	1.125	1.224	1.373	1.353	1.410
2900	EMMA0610	1.151	1.212	1.319	1.487	1.466	1.530

L. 421

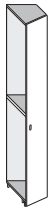

H.  
H.

CODICE  
CODE

TERMINALE 1 ANTA da 499 mm - escluso di fianchi e divisioni  
(a disegno terminale dx, disponibile anche sx)  
END UNIT w/1 DOOR 499 mm - side panels and partitions not included  
(in the drawing, Rh end corner, also available Lh)

2228	EMMT0210	373	401	442	506	497	532
2356	EMMT0310	383	407	458	525	516	548
2580	EMMT0410	394	422	476	549	537	573
2900	EMMT0610	429	460	521	605	591	632



Ulteriori combinazioni di aperture e finiture sono possibili utilizzando le scocche vuote a pag. | Additional finishes and opening combinations are possible using the empty bodies on page 66



# BATTENTE | REGULAR DOOR

## tecno vetro

GLASSES: **cat. 1** light sand, dark sand, rope, stone grey, light grey, medium grey, powder grey, gun metal blue, chrome yellow, green grass, ruby red, black, smoke-grey stopsol, mirror, bronze mirror, smoke mirror. **cat. 2** white, magnolia.







<b>TECNO VETRO 1</b> interno lacc. opaco matt lacq. inside 	<b>TECNO VETRO 2</b> interno lacc. opaco matt lacq. inside 								Maggiorazione per interno laccato opaco  <i>Increase                      for matt lacquered                      inside finish</i>
ANGOLO 2 ANTE da 499 mm - escluso di fianchi e divisioni CORNER w/2 DOORS 499 mm - side panels and partitions not included									
1.291	1.466								281
1.324	1.491								288
1.381	1.565								301
									327
TERMINALE 1 ANTA da 499 mm - escluso di fianchi e divisioni (a disegno terminale dx, disponibile anche sx) END UNIT w/1 DOOR 499 mm - side panels and partitions not included (in the drawing, Rh end corner, also available Lh)									
508	592								62
552	601								64
546	633								68
									71

Ulteriori combinazioni di aperture e finiture sono possibili utilizzando le scocche vuote a pag. | Additional finishes and opening combinations are possible using the empty bodies on page 66

# BATTENTE | REGULAR DOOR

tecno

NETTI: cat. 1 sabbia chiara, sabbia scura, corda, grigio pietra, grigio chiaro, grigio medio, grigio polvere, blu piombo, giallo cromo, verde pompelmo, rosso rubino, nero, stopsol fumé, specchio, specchio bronzo, specchio fumo. cat. 2 bianco, magnolia.

<p>- <b>Attenzione: la finitura dei fianchi segue la finitura dell'anta (ES: anta essenza - fianco essenza / anta vetro - fianco lacc. opaco base).</b></p> <p>- <i>Attention: the finish of the sides follows the finish of the door (EX: wooden door - wooden side / glass door - basic matt lacq. side).</i></p> <p>- <b>Prezzi calcolati con interno melaminico.</b> Dotazione interna vano standard: - N. 1 ripiano - N. 2 tubi appendiabiti - <i>Prices calculated with melamine finish.</i> Standard internal equipment: - 1 shelf - 2 clothes hangers</p> <p>- <b>Maniglia inserita per tutta la lunghezza dell'anta: disponibile in finitura bianco, con maggiorazione di 30 euro per la finitura brill spazzolato e laccato opaco colore (da specificare nell'ordine).</b> - <i>Handle built-in along the length of the door, available in white finish, with increase of 30 euros for the brushed brill finish and matt lacquer colour (to be specified in the order)</i></p>	<p><b>TECNO</b> lacc. opaco base <i>basic matt lacq.</i></p> 	<p><b>TECNO</b> lacc. opaco colore <i>colour matt lacq.</i></p> 	<p><b>TECNO</b> essenza <i>wood</i></p> 	<p><b>TECNO</b> rovere lacc. poro aperto <i>open pore lacq. oak</i></p> 	<p><b>TECNO</b> rovere termotrattato <i>heat-treated oak</i></p> 	<p><b>TECNO</b> lacc. lucido <i>glossy lacq.</i></p> 
	<p><b>Sezione ante   Door section:</b></p> 					

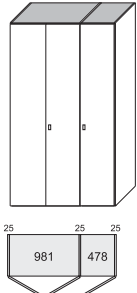
<p><b>L. 1534</b></p> 	H. H.	CODICE CODE	EL. 3 ANTE da 499 mm EL. w/3 DOORS 499 mm					
		2228 EMAB2130	<b>1.238</b>	<b>1.344</b>	<b>1.527</b>	<b>1.802</b>	<b>1.766</b>	<b>1.863</b>
		2356 EMAB3130	<b>1.277</b>	<b>1.376</b>	<b>1.587</b>	<b>1.877</b>	<b>1.843</b>	<b>1.933</b>
		2580 EMAB4130	<b>1.335</b>	<b>1.443</b>	<b>1.670</b>	<b>1.988</b>	<b>1.938</b>	<b>2.047</b>
		2900 EMAB6130	<b>1.469</b>	<b>1.595</b>	<b>1.839</b>	<b>2.201</b>	<b>2.144</b>	<b>2.271</b>

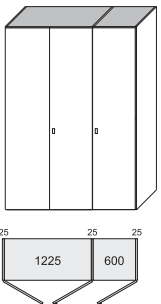
<p><b>L. 1900</b></p> 	H. H.	CODICE CODE	EL. 3 ANTE da 621 mm EL. w/3 DOORS 621 mm					
		2228 EMAB2160	<b>1.411</b>	<b>1.521</b>	<b>1.727</b>	<b>2.043</b>	<b>1.990</b>	<b>2.111</b>
		2356 EMAB3160	<b>1.456</b>	<b>1.573</b>	<b>1.801</b>	<b>2.135</b>	<b>2.083</b>	<b>2.211</b>
		2580 EMAB4160	<b>1.528</b>	<b>1.649</b>	<b>1.896</b>	<b>2.261</b>	<b>2.194</b>	<b>2.343</b>
		2900 EMAB6160	<b>1.681</b>	<b>1.825</b>	<b>2.091</b>	<b>2.506</b>	<b>2.427</b>	<b>2.603</b>

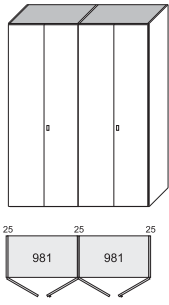
<p><b>L. 2037</b></p> 	H. H.	CODICE CODE	EL. 4 ANTE da 499 mm EL. w/4 DOORS 499 mm					
		2228 EMAB2200	<b>1.463</b>	<b>1.593</b>	<b>1.813</b>	<b>2.153</b>	<b>2.113</b>	<b>2.225</b>
		2356 EMAB3200	<b>1.512</b>	<b>1.634</b>	<b>1.888</b>	<b>2.246</b>	<b>2.208</b>	<b>2.314</b>
		2580 EMAB4200	<b>1.580</b>	<b>1.714</b>	<b>1.986</b>	<b>2.380</b>	<b>2.322</b>	<b>2.452</b>
		2900 EMAB6200	<b>1.742</b>	<b>1.898</b>	<b>2.188</b>	<b>2.634</b>	<b>2.570</b>	<b>2.720</b>

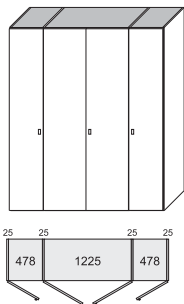

<p><b>L. 2281</b></p> 	H. H.	CODICE CODE	EL. 4 ANTE da 499-621 mm EL. w/4 DOORS 499-621 mm					
		2228 EMAB2210	<b>1.810</b>	<b>1.948</b>	<b>2.186</b>	<b>2.554</b>	<b>2.497</b>	<b>2.646</b>
		2356 EMAB3210	<b>1.865</b>	<b>2.000</b>	<b>2.273</b>	<b>2.661</b>	<b>2.605</b>	<b>2.752</b>
		2580 EMAB4210	<b>1.951</b>	<b>2.096</b>	<b>2.391</b>	<b>2.814</b>	<b>2.741</b>	<b>2.911</b>
		2900 EMAB6210	<b>2.143</b>	<b>2.312</b>	<b>2.632</b>	<b>3.115</b>	<b>3.029</b>	<b>3.228</b>

Ulteriori combinazioni di aperture e finiture sono possibili utilizzando le scocche vuote a pag. | Additional finishes and opening combinations are possible using the empty bodies on page 66

# BATTENTE | REGULAR DOOR

## tecno vetro

GLASSES: **cat. 1** light sand, dark sand, rope, stone grey, light grey, medium grey, powder grey, gun metal blue, chrome yellow, green grass, ruby red, black, smoke-grey stopsol, mirror, bronze mirror, smoke mirror. **cat. 2** white, magnolia.

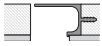
<b>TECNO VETRO 1</b> interno lacc. opaco matt lacq. inside		<b>TECNO VETRO 2</b> interno lacc. opaco matt lacq. inside								Maggiorazione per interno laccato opaco  <i>Increase                      for matt lacquered                      inside finish</i>
										
										
EL. 3 ANTE da 499 mm EL. w/3 DOORS 499 mm										
<b>1.648</b>	<b>1.907</b>								<b>365</b>	
<b>1.699</b>	<b>1.945</b>								<b>391</b>	
<b>1.797</b>	<b>2.068</b>								<b>406</b>	
									<b>443</b>	
EL. 3 ANTE da 621 mm EL. w/3 DOORS 621 mm										
<b>1.897</b>	<b>2.220</b>								<b>415</b>	
<b>1.957</b>	<b>2.270</b>								<b>434</b>	
<b>2.072</b>	<b>2.413</b>								<b>466</b>	
									<b>505</b>	
EL. 4 ANTE da 499 mm EL. w/4 DOORS 499 mm										
<b>2.013</b>	<b>2.363</b>								<b>439</b>	
<b>2.078</b>	<b>2.412</b>								<b>455</b>	
<b>2.200</b>	<b>2.568</b>								<b>484</b>	
									<b>526</b>	
EL. 4 ANTE da 499-621 mm EL. w/4 DOORS 499-621 mm										
<b>2.406</b>	<b>2.792</b>								<b>539</b>	
<b>2.479</b>	<b>2.849</b>								<b>565</b>	
<b>2.620</b>	<b>3.025</b>								<b>605</b>	
									<b>657</b>	

Ulteriori combinazioni di aperture e finiture sono possibili utilizzando le scocche vuote a pag. | Additional finishes and opening combinations are possible using the empty bodies on page 66

# BATTENTE | REGULAR DOOR

tecno

VETRI: cat. 1 sabbia chiaro, sabbia scuro, corda, grigio pietra, grigio chiaro, grigio medio, grigio polvere, blu piombo, giallo cromo, verde pompelmo, rosso rubino, nero, stopsol fumé, specchio, specchio bronzo, specchio fumo. cat. 2 bianco, magnolia.

- **Attenzione: la finitura dei fianchi segue la finitura dell'anta (ES: anta essenza - fianco essenza / anta vetro - fianco lacc. opaco base).**  
 - *Attention: the finish of the sides follows the finish of the door (EX: wooden door - wooden side / glass door - basic matt lacq. side).*  
 - **Prezzi calcolati con interno melaminico.**  
 Dotazione interna vano standard: - N. 1 ripiano - N. 2 tubi appendiabiti  
 - *Prices calculated with melamine finish.*  
 Standard internal equipment: - 1 shelf - 2 clothes hangers  
 - **Maniglia inserita per tutta la lunghezza dell'anta: disponibile in finitura bianco, con maggiorazione di 30 euro per la finitura brill spazzolato e laccato opaco colore (da specificare nell'ordine).**  
 - *Handle built-in along the length of the door, available in white finish, with increase of 30 euros for the brushed brill finish and matt lacquer colour (to be specified in the order)*

TECNO lacc. opaco base basic matt lacq.	TECNO lacc. opaco colore colour matt lacq.	TECNO essenza wood	TECNO rovere lacc. poro aperto open pore lacq. oak	TECNO rovere termotrattato heat-treated oak	TECNO lacc. lucido glossy lacq.

Sezione ante | Door section:





L. 2525	H. H.	CODICE CODE	EL. 4 ANTE da 621 mm EL. w/4 DOORS 621 mm					
			1.735	1.873	2.121	2.519	2.455	2.601
		2228 EMAB2230	1.735	1.873	2.121	2.519	2.455	2.601
		2356 EMAB3230	1.792	1.938	2.214	2.634	2.570	2.726
		2580 EMAB4230	1.882	2.034	2.334	2.792	2.712	2.892
		2900 EMAB6230	2.072	2.252	2.572	3.092	2.998	3.210
L. 2540	H. H.	CODICE CODE	EL. 5 ANTE da 499 mm EL. w/5 DOORS 499 mm					
			1.899	2.057	2.318	2.722	2.673	2.820
		2228 EMAB2240	1.899	2.057	2.318	2.722	2.673	2.820
		2356 EMAB3240	1.960	2.106	2.411	2.836	2.789	2.927
		2580 EMAB4240	2.045	2.207	2.533	3.000	2.930	3.096
		2900 EMAB6240	2.251	2.438	2.789	3.319	3.241	3.432
L. 3150	H. H.	CODICE CODE	EL. 5 ANTE da 621 mm EL. w/5 DOORS 621 mm					
			2.208	2.374	2.672	3.146	3.068	3.256
		2228 EMAB2310	2.208	2.374	2.672	3.146	3.068	3.256
		2356 EMAB3310	2.279	2.455	2.788	3.288	3.210	3.411
		2580 EMAB4310	2.389	2.573	2.933	3.479	3.381	3.612
		2900 EMAB6310	2.628	2.845	3.233	3.853	3.738	4.009
L. 3043	H. H.	CODICE CODE	EL. 6 ANTE da 499 mm EL. w/6 DOORS 499 mm					
			2.124	2.306	2.604	3.073	3.020	3.182
		2228 EMAB2300	2.124	2.306	2.604	3.073	3.020	3.182
		2356 EMAB3300	2.195	2.364	2.712	3.205	3.154	3.308
		2580 EMAB4300	2.290	2.478	2.849	3.392	3.314	3.501
		2900 EMAB6300	2.524	2.741	3.138	3.752	3.667	3.881

Ulteriori combinazioni di aperture e finiture sono possibili utilizzando le scocche vuote a pag. | Additional finishes and opening combinations are possible using the empty bodies on page 66

# BATTENTE | REGULAR DOOR

## tecno vetro

GLASSES: **cat. 1** light sand, dark sand, rope, stone grey, light grey, medium grey, powder grey, gun metal blue, chrome yellow, green grass, ruby red, black, smoke-grey stopsol, mirror, bronze mirror, smoke mirror. **cat. 2** white, magnolia.

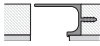
<b>TECNO VETRO 1</b> interno lacc. opaco matt lacq. inside		<b>TECNO VETRO 2</b> interno lacc. opaco matt lacq. inside							Maggiorazione per interno laccato opaco  <i>Increase                      for matt lacquered                      inside finish</i>
									
									
EL. 4 ANTE da 621 mm EL. w/4 DOORS 621 mm									
<b>2.387</b>	<b>2.823</b>							<b>501</b>	
<b>2.464</b>	<b>2.888</b>							<b>523</b>	
<b>2.612</b>	<b>3.074</b>							<b>560</b>	
								<b>606</b>	
EL. 5 ANTE da 499 mm EL. w/5 DOORS 499 mm									
<b>2.584</b>	<b>3.018</b>							<b>582</b>	
<b>2.665</b>	<b>3.078</b>							<b>605</b>	
<b>2.817</b>	<b>3.272</b>							<b>645</b>	
								<b>700</b>	
EL. 5 ANTE da 621 mm EL. w/5 DOORS 621 mm									
<b>3.020</b>	<b>3.561</b>							<b>663</b>	
<b>3.116</b>	<b>3.641</b>							<b>692</b>	
<b>3.298</b>	<b>3.870</b>							<b>743</b>	
								<b>802</b>	
EL. 6 ANTE da 499 mm EL. w/6 DOORS 499 mm									
<b>2.949</b>	<b>3.474</b>							<b>656</b>	
<b>3.044</b>	<b>3.545</b>							<b>679</b>	
<b>3.220</b>	<b>3.772</b>							<b>723</b>	
								<b>783</b>	

Ulteriori combinazioni di aperture e finiture sono possibili utilizzando le scocche vuote a pag. | Additional finishes and opening combinations are possible using the empty bodies on page 66

# BATTENTE | REGULAR DOOR

tecno

VETRI: cat. 1 sabbia chiaro, sabbia scuro, corda, grigio pietra, grigio chiaro, grigio medio, grigio polvere, blu piombo, giallo cromo, verde pompelmo, rosso rubino, nero, stopsol fumé, specchio, specchio bronzo, specchio fumo. cat. 2 bianco, magnolia.

- **Attenzione: la finitura dei fianchi segue la finitura dell'anta (ES: anta essenza - fianco essenza / anta vetro - fianco lacc. opaco base).**  
 - *Attention: the finish of the sides follows the finish of the door (EX: wooden door - wooden side / glass door - basic matt lacq. side).*  
 - **Prezzi calcolati con interno melaminico.**  
 Dotazione interna vano standard: - N. 1 ripiano - N. 2 tubi appendiabiti  
 - *Prices calculated with melamine finish.*  
 Standard internal equipment: - 1 shelf - 2 clothes hangers  
 - **Maniglia inserita per tutta la lunghezza dell'anta: disponibile in finitura bianco, con maggiorazione di 30 euro per la finitura brill spazzolato e laccato opaco colore (da specificare nell'ordine).**  
 - *Handle built-in along the length of the door, available in white finish, with increase of 30 euros for the brushed brill finish and matt lacquer colour (to be specified in the order)*

TECNO lacc. opaco base basic matt lacq.	TECNO lacc. opaco colore colour matt lacq.	TECNO essenza wood	TECNO rovere lacc. poro aperto open pore lacq. oak	TECNO rovere termotrattato heat-treated oak	TECNO lacc. lucido glossy lacq.

Sezione ante | Door section:



## L. 3287

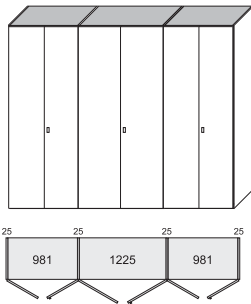

H.  
H.

CODICE  
CODE

EL. 6 ANTE da 499-621 mm  
EL. w/6 DOORS 499-621 mm

2228	EMAB2320	<b>2.260</b>	<b>2.446</b>	<b>2.758</b>	<b>3.256</b>	<b>3.191</b>	<b>3.370</b>
2356	EMAB3320	<b>2.335</b>	<b>2.516</b>	<b>2.875</b>	<b>3.399</b>	<b>3.335</b>	<b>3.514</b>
2580	EMAB4320	<b>2.441</b>	<b>2.638</b>	<b>3.023</b>	<b>3.598</b>	<b>3.509</b>	<b>3.721</b>
2900	EMAB6320	<b>2.689</b>	<b>2.918</b>	<b>3.330</b>	<b>3.981</b>	<b>3.881</b>	<b>4.126</b>

## L. 3531

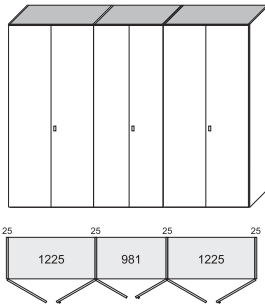

H.  
H.

CODICE  
CODE

EL. 6 ANTE da 499-621 mm  
EL. w/6 DOORS 499-621 mm

2228	EMAB2330	<b>2.396</b>	<b>2.586</b>	<b>2.912</b>	<b>3.439</b>	<b>3.362</b>	<b>3.558</b>
2356	EMAB3330	<b>2.475</b>	<b>2.668</b>	<b>3.038</b>	<b>3.593</b>	<b>3.516</b>	<b>3.720</b>
2580	EMAB4330	<b>2.592</b>	<b>2.798</b>	<b>3.197</b>	<b>3.804</b>	<b>3.704</b>	<b>3.941</b>
2900	EMAB6330	<b>2.854</b>	<b>3.095</b>	<b>3.522</b>	<b>4.210</b>	<b>4.095</b>	<b>4.371</b>

## L. 3775

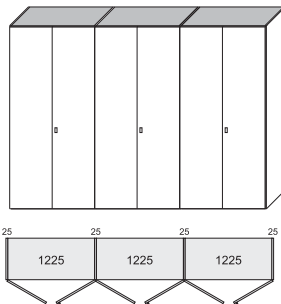

H.  
H.

CODICE  
CODE

EL. 6 ANTE da 621 mm  
EL. w/6 DOORS 621 mm

2228	EMAB2360	<b>2.532</b>	<b>2.726</b>	<b>3.066</b>	<b>3.622</b>	<b>3.533</b>	<b>3.746</b>
2356	EMAB3360	<b>2.615</b>	<b>2.820</b>	<b>3.201</b>	<b>3.787</b>	<b>3.697</b>	<b>3.926</b>
2580	EMAB4360	<b>2.743</b>	<b>2.958</b>	<b>3.371</b>	<b>4.010</b>	<b>3.899</b>	<b>4.161</b>
2900	EMAB6360	<b>3.019</b>	<b>3.272</b>	<b>3.714</b>	<b>4.439</b>	<b>4.309</b>	<b>4.616</b>

## L. 4049

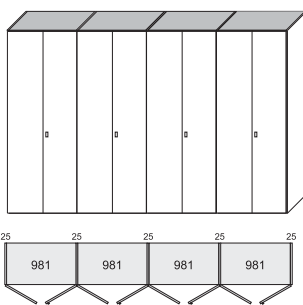

H.  
H.

CODICE  
CODE

EL. 8 ANTE da 499 mm  
EL. w/8 DOORS 499 mm



2228	EMAB2400	<b>2.785</b>	<b>3.019</b>	<b>3.395</b>	<b>3.993</b>	<b>3.927</b>	<b>4.139</b>
2356	EMAB3400	<b>2.878</b>	<b>3.094</b>	<b>3.536</b>	<b>4.164</b>	<b>4.100</b>	<b>4.302</b>
2580	EMAB4400	<b>3.000</b>	<b>3.242</b>	<b>3.712</b>	<b>4.404</b>	<b>4.306</b>	<b>4.550</b>
2900	EMAB6400	<b>3.306</b>	<b>3.584</b>	<b>4.088</b>	<b>4.870</b>	<b>4.764</b>	<b>5.042</b>

Ulteriori combinazioni di aperture e finiture sono possibili utilizzando le scocche vuote a pag. | Additional finishes and opening combinations are possible using the empty bodies on page 66

# BATTENTE | REGULAR DOOR

## tecno vetro

GLASSES: **cat. 1** light sand, dark sand, rope, stone grey, light grey, medium grey, powder grey, gun metal blue, chrome yellow, green grass, ruby red, black, smoke-grey stopsol, mirror, bronze mirror, smoke mirror. **cat. 2** white, magnolia.

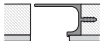
<b>TECNO VETRO 1</b> interno lacc. opaco matt lacq. inside		<b>TECNO VETRO 2</b> interno lacc. opaco matt lacq. inside							Maggiorazione per interno laccato opaco  Increase for matt lacquered inside finish
									
									
EL. 6 ANTE da 499-621 mm EL. w/6 DOORS 499-621 mm									
<b>3.136</b>	<b>3.704</b>							<b>687</b>	
<b>3.237</b>	<b>3.783</b>							<b>713</b>	
<b>3.426</b>	<b>4.025</b>							<b>761</b>	
								<b>823</b>	
EL. 6 ANTE da 499-621 mm EL. w/6 DOORS 499-621 mm									
<b>3.323</b>	<b>3.934</b>							<b>718</b>	
<b>3.430</b>	<b>4.021</b>							<b>747</b>	
<b>3.632</b>	<b>4.278</b>							<b>799</b>	
								<b>863</b>	
EL. 6 ANTE da 621 mm EL. w/6 DOORS 621 mm									
<b>3.510</b>	<b>4.164</b>							<b>749</b>	
<b>3.623</b>	<b>4.259</b>							<b>781</b>	
<b>3.838</b>	<b>4.531</b>							<b>837</b>	
								<b>903</b>	
EL. 8 ANTE da 499 mm EL. w/8 DOORS 499 mm									
<b>3.885</b>	<b>4.585</b>							<b>873</b>	
<b>4.010</b>	<b>4.678</b>							<b>903</b>	
<b>4.240</b>	<b>4.976</b>							<b>962</b>	
								<b>1.040</b>	

Ulteriori combinazioni di aperture e finiture sono possibili utilizzando le scocche vuote a pag. | Additional finishes and opening combinations are possible using the empty bodies on page 66

# BATTENTE | REGULAR DOOR

tecno ante | doors L. 621 + 377

VETRI: cat. 1 sabbia chiaro, sabbia scuro, corda, grigio pietra, grigio chiaro, grigio medio, grigio polvere, blu piombo, giallo cromo, verde pompelmo, rosso rubino, nero, stopsol fumé, specchio, specchio bronzo, specchio fumo. cat. 2 bianco, magnolia.

- Fianchi e divisioni a pag. | Side panels and partitions on page 24

- Prezzi calcolati con interno melaminico.







Dotazione interna vano standard: - N. 1 ripiano - N. 2 tubi appendiabiti

- Prices calculated with melamine finish.

Standard internal equipment: - 1 shelf - 2 clothes hangers

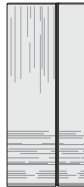
- Maniglia inserita per tutta la lunghezza dell'anta: disponibile in finitura bianco, con maggiorazione di 30 euro per la finitura brill spazzolato e laccato opaco colore (da specificare nell'ordine).

- Handle built-in along the length of the door, available in white finish, with increase of 30 euros for the brushed brill finish and matt lacquer colour (to be specified in the order).

TECNO lacc. opaco base basic matt lacq.	TECNO lacc. opaco colore colour matt lacq.	TECNO essenza wood	TECNO rovere lacc. poro aperto open pore lacq. oak	TECNO rovere termotrattato heat-treated oak	TECNO lacc. lucido glossy lacq.
					

Sezione ante | Door section:



L. 981

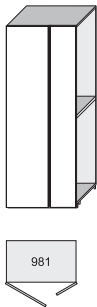

H.  
H.

CODICE  
CODE

EL. 1 ANTA da 621 + 1 ANTA da 377 mm - escluso di fianchi e divisioni  
EL. w/ 1 DOOR 621 + 1 DOOR 377 mm - side panels and partitions not included

2228	EMMB0250	<b>555</b>	<b>601</b>	<b>674</b>	<b>801</b>	<b>786</b>	<b>832</b>
2356	EMMB0350	<b>572</b>	<b>621</b>	<b>704</b>	<b>837</b>	<b>821</b>	<b>872</b>
2580	EMMB0450	<b>598</b>	<b>649</b>	<b>741</b>	<b>885</b>	<b>866</b>	<b>924</b>
2900	EMMB0650	<b>655</b>	<b>714</b>	<b>811</b>	<b>975</b>	<b>953</b>	<b>1.019</b>

Ulteriori combinazioni di aperture e finiture sono possibili utilizzando le scocche vuote a pag. | Additional finishes and opening combinations are possible using the empty bodies on page 66





# BATTENTE | REGULAR DOOR

## tecno ante | doors L. 621 + 377

VETRI: cat. 1 sabbia chiara, sabbia scura, corda, grigio pietra, grigio chiaro, grigio medio, grigio polvere, blu piombo, giallo cromo, verde pompelmo, rosso rubino, nero, stopsol fumé, specchio, specchio bronzo, specchio fumo. cat. 2 bianco, magnolia.

- **Attenzione: la finitura dei fianchi segue la finitura dell'anta (ES: anta essenza - fianco essenza / anta vetro - fianco lacc. opaco base).**  
 - *Attention: the finish of the sides follows the finish of the door (EX: wooden door - wooden side / glass door - basic matt lacq. side).*  
 - **Prezzi calcolati con interno melaminico.**  
 Dotazione interna vano standard: - N. 1 ripiano - N. 2 tubi appendiabiti  
 - *Prices calculated with melamine finish.*  
 Standard internal equipment: - 1 shelf - 2 clothes hangers  
 - **Maniglia inserita per tutta la lunghezza dell'anta: disponibile in finitura bianco, con maggiorazione di 30 euro per la finitura brill spazzolato e laccato opaco colore (da specificare nell'ordine).**  
 - *Handle built-in along the length of the door, available in white finish, with increase of 30 euros for the brushed brill finish and matt lacquer colour (to be specified in the order)*

TECNO lacc. opaco base basic matt lacq.	TECNO lacc. opaco colore colour matt lacq.	TECNO essenza wood	TECNO rovere lacc. poro aperto open pore lacq. oak	TECNO rovere termotrattato heat-treated oak	TECNO lacc. lucido glossy lacq.

Sezione ante | Door section:



### L. 2037

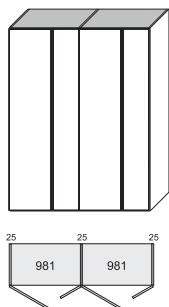

H. H.	CODICE CODE	EL. 4 ANTE da 621-377 mm EL. w/4 DOORS 621-377 mm					
2228	EMAB2200	<b>1.413</b>	<b>1.531</b>	<b>1.741</b>	<b>2.077</b>	<b>2.033</b>	<b>2.137</b>
2356	EMAB3200	<b>1.458</b>	<b>1.584</b>	<b>1.816</b>	<b>2.170</b>	<b>2.126</b>	<b>2.238</b>
2580	EMAB4200	<b>1.532</b>	<b>1.660</b>	<b>1.918</b>	<b>2.302</b>	<b>2.246</b>	<b>2.378</b>
2900	EMAB6200	<b>1.688</b>	<b>1.840</b>	<b>2.110</b>	<b>2.548</b>	<b>2.482</b>	<b>2.636</b>

### L. 3043

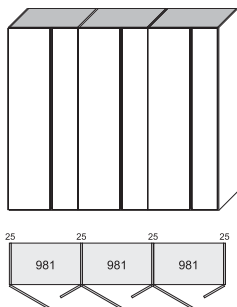

H. H.	CODICE CODE	EL. 6 ANTE da 621-377 mm EL. w/6 DOORS 621-377 mm					
2228	EMAB2300	<b>2.049</b>	<b>2.213</b>	<b>2.496</b>	<b>2.959</b>	<b>2.900</b>	<b>3.050</b>
2356	EMAB3300	<b>2.114</b>	<b>2.289</b>	<b>2.604</b>	<b>3.091</b>	<b>3.031</b>	<b>3.194</b>
2580	EMAB4300	<b>2.218</b>	<b>2.397</b>	<b>2.747</b>	<b>3.275</b>	<b>3.200</b>	<b>3.390</b>
2900	EMAB6300	<b>2.443</b>	<b>2.654</b>	<b>3.021</b>	<b>3.623</b>	<b>3.535</b>	<b>3.755</b>

### L. 4049

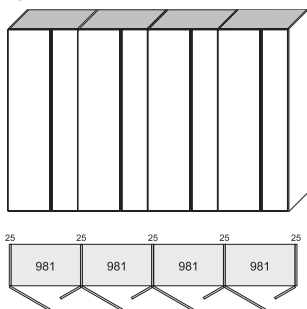



H. H.	CODICE CODE	EL. 8 ANTE da 621-377 mm EL. w/8 DOORS 621-377 mm					
2228	EMAB2400	<b>2.685</b>	<b>2.895</b>	<b>3.251</b>	<b>3.841</b>	<b>3.767</b>	<b>3.963</b>
2356	EMAB3400	<b>2.770</b>	<b>2.994</b>	<b>3.392</b>	<b>4.012</b>	<b>3.936</b>	<b>4.150</b>
2580	EMAB4400	<b>2.904</b>	<b>3.134</b>	<b>3.576</b>	<b>4.248</b>	<b>4.154</b>	<b>4.402</b>
2900	EMAB6400	<b>3.198</b>	<b>3.468</b>	<b>3.932</b>	<b>4.698</b>	<b>4.588</b>	<b>4.874</b>

Ulteriori combinazioni di aperture e finiture sono possibili utilizzando le scocche vuote a pag. | Additional finishes and opening combinations are possible using the empty bodies on page 66

# BATTENTE | REGULAR DOOR

## tecno vetro ante | doors L. 621 + 377



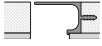

GLASSES: **cat. 1** light sand, dark sand, rope, stone grey, light grey, medium grey, powder grey, gun metal blue, chrome yellow, green grass, ruby red, black, smoke-grey stopsol, mirror, bronze mirror, smoke mirror. **cat. 2** white, magnolia.

<b>TECNO VETRO 1</b> interno lacc. opaco matt lacq. inside		<b>TECNO VETRO 2</b> interno lacc. opaco matt lacq. inside								Maggiorazione per interno laccato opaco  <i>Increase                      for matt lacquered                      inside finish</i>
										
										
EL. 4 ANTE da 621-377 mm EL. w/4 DOORS 621-377 mm										
<b>1.959</b>	<b>2.309</b>								<b>439</b>	
<b>2.028</b>	<b>2.368</b>								<b>455</b>	
<b>2.146</b>	<b>2.516</b>								<b>484</b>	
									<b>526</b>	
EL. 6 ANTE da 621-377 mm EL. w/6 DOORS 621-377 mm										
<b>2.868</b>	<b>3.393</b>								<b>656</b>	
<b>2.969</b>	<b>3.479</b>								<b>679</b>	
<b>3.139</b>	<b>3.694</b>								<b>723</b>	
									<b>783</b>	
EL. 8 ANTE da 621-377 mm EL. w/8 DOORS 621-377 mm										
<b>3.777</b>	<b>4.477</b>								<b>873</b>	
<b>3.910</b>	<b>4.590</b>								<b>903</b>	
<b>4.132</b>	<b>4.872</b>								<b>962</b>	
									<b>1.040</b>	

Ulteriori combinazioni di aperture e finiture sono possibili utilizzando le scocche vuote a pag. | Additional finishes and opening combinations are possible using the empty bodies on page 66

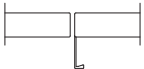
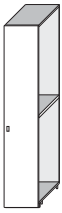
# BATTENTE | REGULAR DOOR

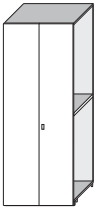
glass vetro

<p>- Fianchi e divisioni a pag.   <i>Side panels and partitions on page 24</i></p> <p>- Prezzi calcolati con interno melaminico. Dotazione interna vano standard: - N. 1 ripiano - N. 2 tubi appendiabiti - <i>Prices calculated with melamine finish.</i> Standard internal equipment: - 1 shelf - 2 clothes hangers</p>		<p>GLASS</p> 							
		<p>Sezione ante   <i>Door section:</i></p> 							
<p><b>L. 478</b></p>  	H. H.	CODICE CODE	<p>EL. 1 ANTA da 499 mm - escluso di fianchi e divisioni <i>EL. w/1 DOOR 499 mm - side panels and partitions not included</i></p>						
		2228 EMMB0220	<b>491</b>						
		2356 EMMB0320	<b>506</b>						
		2580 EMMB0420	<b>527</b>						
<p><b>L. 981</b></p>  	H. H.	CODICE CODE	<p>EL. 2 ANTE da 499 mm - escluso di fianchi e divisioni <i>EL. w/2 DOORS 499 mm - side panels and partitions not included</i></p>						
		2228 EMMB0250	<b>899</b>						
		2356 EMMB0350	<b>930</b>						
		2580 EMMB0450	<b>970</b>						

Ulteriori combinazioni di aperture e finiture sono possibili utilizzando le scocche vuote a pag. | *Additional finishes and opening combinations are possible using the empty bodies on page 66*



# BATTENTE | REGULAR DOOR

glass vetro

- **Attenzione: la finitura dei fianchi segue la finitura dell'anta (ES: anta vetro - fianco lacc. opaco base).**  
 - *Attention: the finish of the sides follows the finish of the door (EX. glass door - basic matt lacq. side).*

- **Prezzi calcolati con interno melaminico.**  
**Dotazione interna vano standard: - N. 1 ripiano - N. 2 tubi appendiabiti**  
 - *Prices calculated with melamine finish.*  
**Standard internal equipment: - 1 shelf - 2 clothes hangers**

GLASS



Maggiorazione per interno laccato opaco  
*Increase for matt lacquered inside finish*

Sezione ante | Door section:

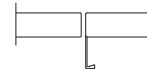

L. 1534	H. H.	CODICE CODE	EL. 3 ANTE da 499 mm EL. w/3 DOORS 499 mm			
			2228	EMAB2130	1.693	365
			2356	EMAB3130	1.750	381
			2580	EMAB4130	1.833	406
L. 2037	H. H.	CODICE CODE	EL. 4 ANTE da 499 mm EL. w/4 DOORS 499 mm			
			2228	EMAB2200	2.101	439
			2356	EMAB3200	2.174	455
			2580	EMAB4200	2.276	484
L. 2540	H. H.	CODICE CODE	EL. 5 ANTE da 499 mm EL. w/5 DOORS 499 mm			
			2228	EMAB2240	2.673	582
			2356	EMAB3240	2.764	605
			2580	EMAB4240	2.891	645

Ulteriori combinazioni di aperture e finiture sono possibili utilizzando le scocche vuote a pag. | Additional finishes and opening combinations are possible using the empty bodies on page 66

# BATTENTE | REGULAR DOOR

glass vetro

- **Attenzione: la finitura dei fianchi segue la finitura dell'anta (ES: anta vetro - fianco lacc. opaco base).**

- *Attention: the finish of the sides follows the finish of the door (EX. glass door - basic matt lacq. side).*

- **Prezzi calcolati con interno melaminico.**

**Dotazione interna vano standard: - N. 1 ripiano - N. 2 tubi appendiabiti**

- *Prices calculated with melamine finish.*

**Standard internal equipment: - 1 shelf - 2 clothes hangers**

GLASS



Maggiorazione per interno laccato opaco

*Increase for matt lacquered inside finish*

Sezione ante | Door section:

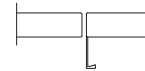

**L. 3043**

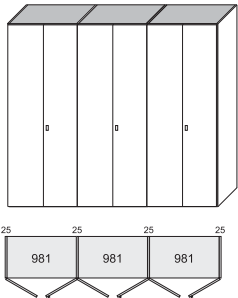

H.  
H.

CODICE  
CODE

EL. 6 ANTE da 499 mm  
EL. w/6 DOORS 499 mm

2228	EMAB2300	<b>3.081</b>				<b>665</b>
2356	EMAB3300	<b>3.188</b>				<b>679</b>
2580	EMAB4300	<b>3.334</b>				<b>723</b>

**L. 4049**

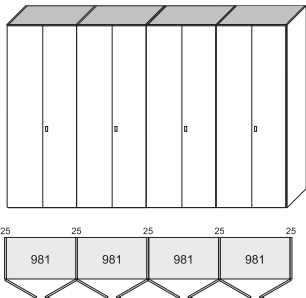

H.  
H.

CODICE  
CODE

EL. 8 ANTE da 499 mm  
EL. w/8 DOORS 499 mm

2228	EMAB2400	<b>4.061</b>				<b>873</b>
2356	EMAB3400	<b>4.202</b>				<b>903</b>
2580	EMAB4400	<b>4.392</b>				<b>962</b>

Ulteriori combinazioni di aperture e finiture sono possibili utilizzando le scocche vuote a pag. | Additional finishes and opening combinations are possible using the empty bodies on page 66

# BATTENTE | *REGULAR DOOR*

caratteristiche dimensionali dell'elemento ponte | *dimensional characteristics of the span unit*

- L'elemento ponte va posizionato sempre tra due moduli armadio.
- L'anta impiegata nel ponte è la SIMPLY in tutte le sue finiture e sempre senza maniglia, la presa dell'anta infatti avviene attraverso la sporgenza che rimane sotto.
- Il lato interno del ponte (vedi es. sotto\*) segue la finitura del fianco, mentre il vano interno è disponibile in melaminico magnolia, melaminico rovere termotrattato, decorativo tessuto e laccato opaco.

- *The span unit is always positioned between two wardrobe modules.*
- *The door used in the span unit is the SIMPLY in all its finishes, and always without a handle, the door can, in fact, be opened through the ledge at the bottom.*
- *The inner side of the span unit (see ex. below \*) follows the finish of the side panel, while the interior is available in magnolia, heat-treated oak melamine, decorative material and matt lacquer.*

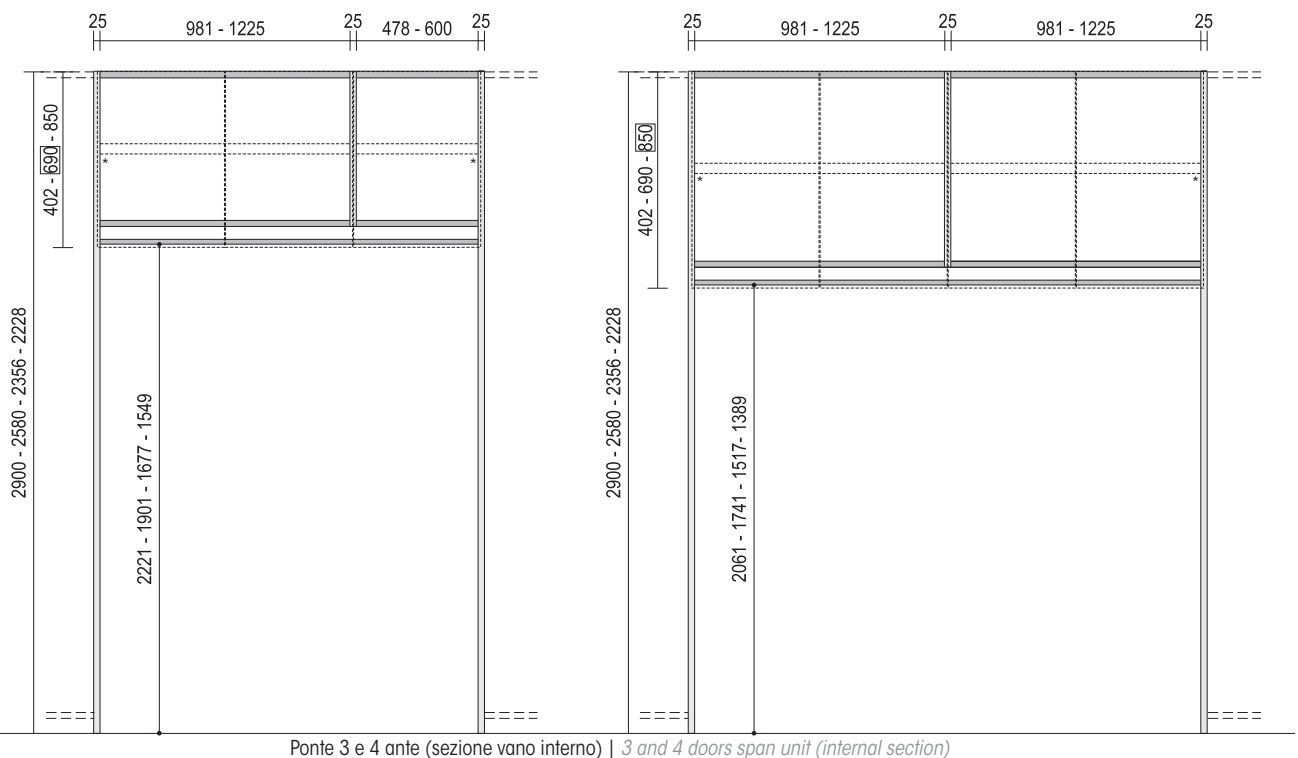
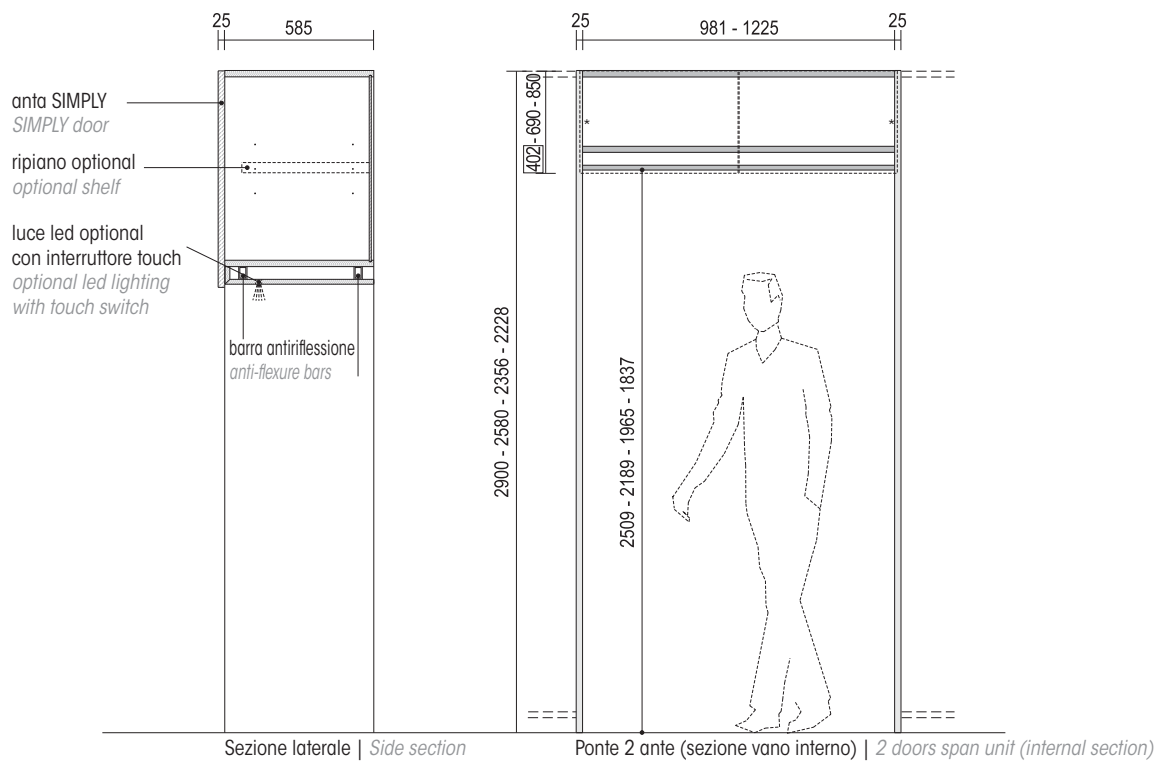



# BATTENTE | REGULAR DOOR

esempi di utilizzo del ponte e dei piani scrivania | *examples of use of span unit and desk tops*

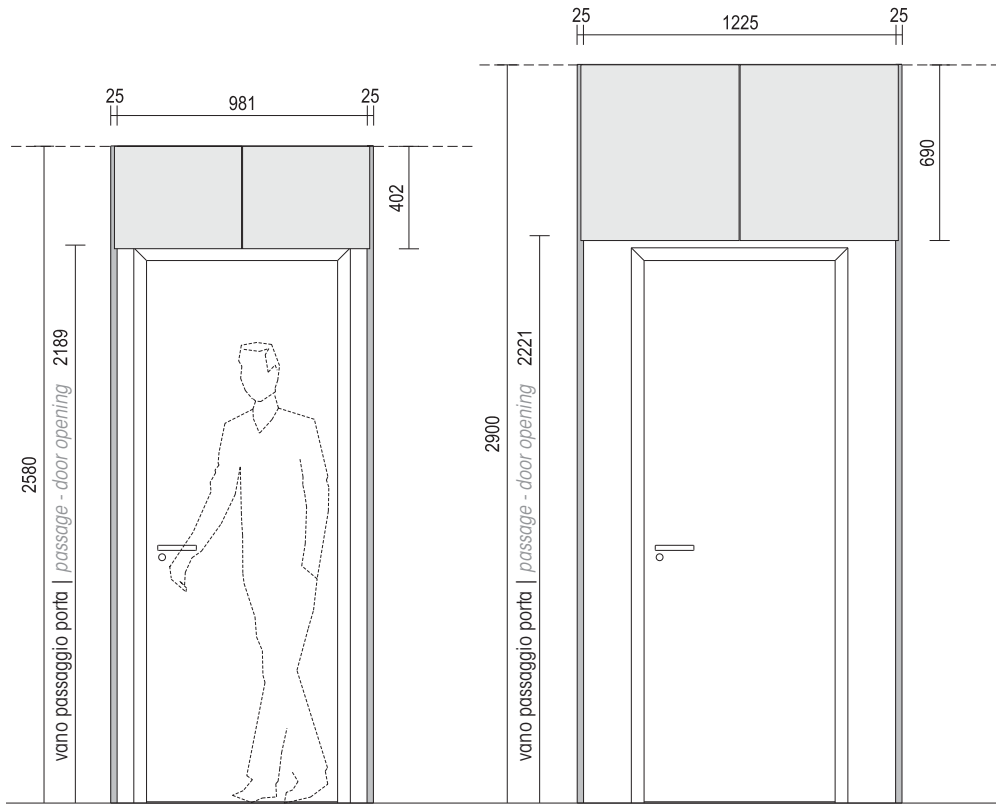

Esempi di ponte sopra un passaggio o una porta | *Examples of span unit over a passage or a door*

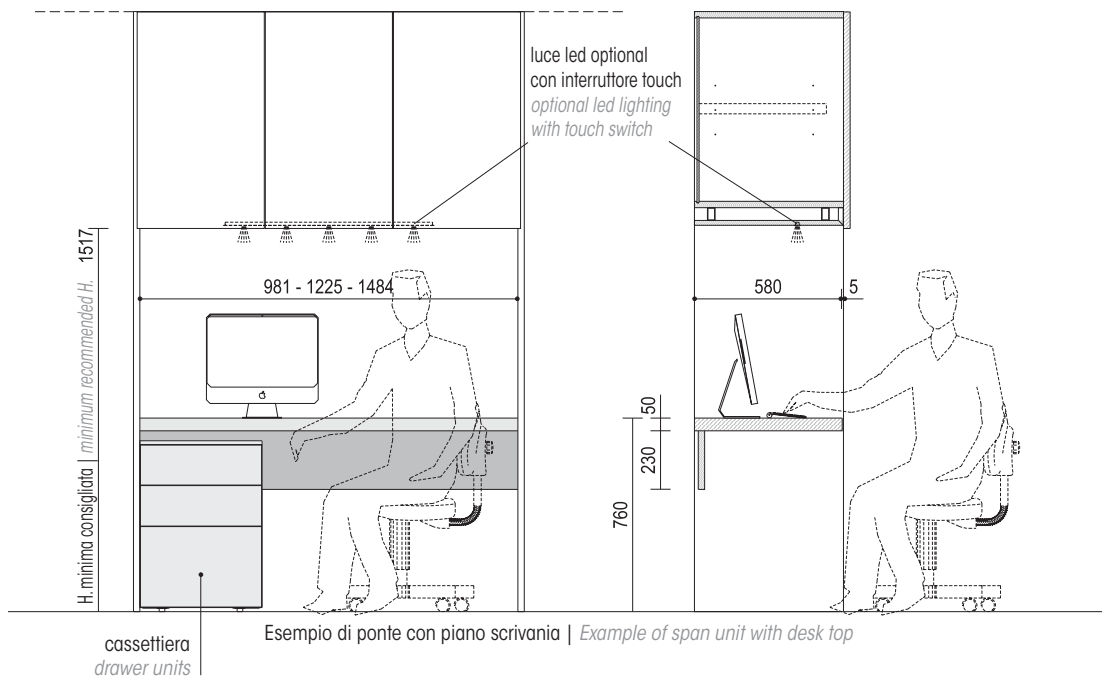

Esempio di ponte con piano scrivania | *Example of span unit with desk top*

PONTI  
BRIDGE ELEMENTS







# BATTENTE | REGULAR DOOR

ponete con anta simply | span unit with simply door H. 402

- Aggiungere sempre i fianchi a pag. | Add always side panels on page 24

- Prezzi calcolati con interno melaminico.  
Dotazione interna vano standard: non prevista.  
- Prices calculated with melamine inside finish.  
Standard internal equipment: not included.

- Anta sempre senza maniglia, la presa avviene sotto l'anta.  
- Door always without handle, it can be opened from the bottom.

SIMPLY lacc. opaco base basic matt lacq.	SIMPLY lacc. opaco colore colour matt lacq.	SIMPLY essenza wood	SIMPLY rovere lacc. poro aperto open pore lacq. oak	SIMPLY rovere termotrattato heat-treated oak	SIMPLY lacc. lucido glossy lacq.
					

Maggiorazione per interno laccato opaco

Increase for matt lacquered inside finish

Sezione ante | Door section:



modulo | module 981

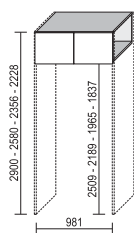

CODICE  
CODE  
PONTE 2 ANTE da 499 mm  
SPAN UNIT. w/2 DOORS 499 mm

EMMPO240	<b>468</b>	<b>481</b>	<b>511</b>	<b>572</b>	<b>563</b>	<b>561</b>	<b>44</b>
----------	------------	------------	------------	------------	------------	------------	-----------

modulo | module 1225

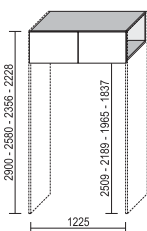

CODICE  
CODE  
PONTE 2 ANTE da 621 mm  
SPAN UNIT. w/2 DOORS 621 mm

EMMPO250	<b>518</b>	<b>533</b>	<b>567</b>	<b>644</b>	<b>630</b>	<b>631</b>	<b>56</b>
----------	------------	------------	------------	------------	------------	------------	-----------

modulo | module 981 + 478

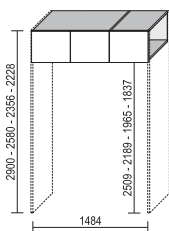

CODICE  
CODE  
PONTE 3 ANTE da 499 mm  
SPAN UNIT. w/3 DOORS 499 mm

EMMPO260	<b>678</b>	<b>696</b>	<b>739</b>	<b>832</b>	<b>818</b>	<b>813</b>	<b>78</b>
----------	------------	------------	------------	------------	------------	------------	-----------

L. modulo | module 1225 + 600

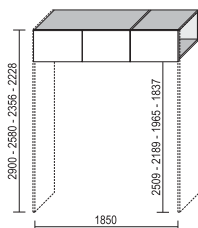

CODICE  
CODE  
PONTE 3 ANTE da 621 mm  
SPAN UNIT. w/3 DOORS 621 mm

EMMPO270	<b>754</b>	<b>776</b>	<b>829</b>	<b>945</b>	<b>920</b>	<b>927</b>	<b>95</b>
----------	------------	------------	------------	------------	------------	------------	-----------







# BATTENTE | REGULAR DOOR

ponete con anta simply | span unit with simply door H. 402

- Aggiungere sempre i fianchi a pag. | Add always side panels on page 24

- Prezzi calcolati con interno melaminico. Dotazione interna vano standard: non prevista.  
- Prices calculated with melamine inside finish. Standard internal equipment: not included.

- Anta sempre senza maniglia, la presa avviene sotto l'anta.  
- Door always without handle, it can be opened from the bottom.

SIMPLY lacc. opaco base basic matt lacq.	SIMPLY lacc. opaco colore colour matt lacq.	SIMPLY essenza wood	SIMPLY rovere lacc. poro aperto open pore lacq. oak	SIMPLY rovere termotrattato heat-treated oak	SIMPLY lacc. lucido glossy lacq.
					

Maggiorazione per interno laccato opaco  
*Increase for matt lacquered inside finish*

Sezione ante | Door section:



modulo | module 981 + 981

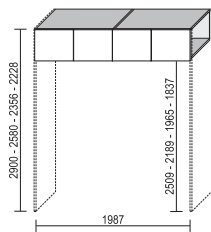

CODICE  
CODE  
PONTE 4 ANTE da 499 m  
SPAN UNIT. w/4 DOORS 499 mm

EMMPO280	<b>822</b>	<b>848</b>	<b>906</b>	<b>1.034</b>	<b>1.015</b>	<b>1.009</b>	<b>101</b>
----------	------------	------------	------------	--------------	--------------	--------------	------------

modulo | module 1225 + 1225

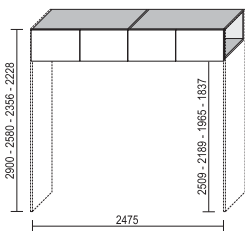







CODICE  
CODE  
PONTE 4 ANTE da 621 mm  
SPAN UNIT. w/4 DOORS 621 mm

EMMPO290	<b>928</b>	<b>958</b>	<b>1.024</b>	<b>1.182</b>	<b>1.148</b>	<b>1.154</b>	<b>125</b>
----------	------------	------------	--------------	--------------	--------------	--------------	------------

# BATTENTE | REGULAR DOOR

ponete con anta simply | span unit with simply door H. 690

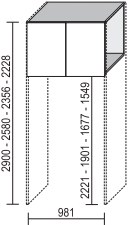
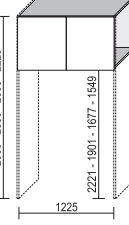
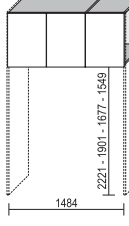
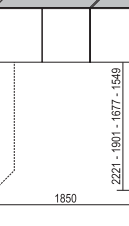
<p>- Aggiungere sempre i fianchi a pag.   <i>Add always side panels on page 24</i></p> <p>- Prezzi calcolati con interno melaminico. Dotazione interna vano standard: non prevista, possibile inserimento di n. 1 ripiano per modulo. <i>Prices calculated with melamine inside finish. Standard internal equipment: not included, possible addition of 1 shelf per module.</i></p> <p>- Anta sempre senza maniglia, la presa avviene sotto l'anta. <i>Door always without handle, it can be opened from the bottom.</i></p>	<p><b>SIMPLY</b> lacc. opaco base <i>basic matt lacq.</i></p> 	<p><b>SIMPLY</b> lacc. opaco colore <i>colour matt lacq.</i></p> 	<p><b>SIMPLY</b> essenza <i>wood</i></p> 	<p><b>SIMPLY</b> rovere lacc. poro aperto <i>open pore lacq. oak</i></p> 	<p><b>SIMPLY</b> rovere termotrattato <i>heat-treated oak</i></p> 	<p><b>SIMPLY</b> lacc. lucido <i>glossy lacq.</i></p> 	<p>Maggiorazione per interno laccato opaco <i>Increase for matt lacquered inside finish</i></p>
	<p>Sezione ante   <i>Door section:</i></p> 						
<p><b>modulo   module 981</b></p> 	<p>CODICE CODE</p> <p>PONTE 2 ANTE da 499 mm <i>SPAN UNIT. w/2 DOORS 499 mm</i></p>						
EMMPO340	<b>514</b>	<b>531</b>	<b>559</b>	<b>646</b>	<b>623</b>	<b>637</b>	<b>50</b>
<p><b>modulo   module 1225</b></p> 	<p>CODICE CODE</p> <p>PONTE 2 ANTE da 621 mm <i>SPAN UNIT. w/2 DOORS 621 mm</i></p>						
EMMPO350	<b>574</b>	<b>591</b>	<b>631</b>	<b>738</b>	<b>712</b>	<b>727</b>	<b>64</b>
<p><b>modulo   module 981 + 478</b></p> 	<p>CODICE CODE</p> <p>PONTE 3 ANTE da 499 mm <i>SPAN UNIT. w/3 DOORS 499 mm</i></p>						
EMMPO360	<b>757</b>	<b>781</b>	<b>821</b>	<b>953</b>	<b>918</b>	<b>937</b>	<b>98</b>
<p><b>L. modulo   module 1225 + 600</b></p> 	<p>CODICE CODE</p> <p>PONTE 3 ANTE da 621 mm <i>SPAN UNIT. w/3 DOORS 621 mm</i></p>						
EMMPO370	<b>846</b>	<b>871</b>	<b>933</b>	<b>1.094</b>	<b>1.051</b>	<b>1.079</b>	<b>117</b>

# BATTENTE | REGULAR DOOR

ponete con anta simply | span unit with simply door H. 690

- Aggiungere sempre i fianchi a pag. | Add always side panels on page 24

- Prezzi calcolati con interno melaminico. Dotazione interna vano standard: non prevista, possibile inserimento di n. 1 ripiano per modulo.

- Prices calculated with melamine inside finish. Standard internal equipment: not included, possible addition of 1 shelf per module.

- Anta sempre senza maniglia, la presa avviene sotto l'anta. - Door always without handle, it can be opened from the bottom.

SIMPLY lacc. opaco base basic matt lacq.	SIMPLY lacc. opaco colore colour matt lacq.	SIMPLY essenza wood	SIMPLY rovere lacc. poro aperto open pore lacq. oak	SIMPLY rovere termotrattato heat-treated oak	SIMPLY lacc. lucido glossy lacq.

Maggiorazione per interno laccato opaco  
*Increase for matt lacquered inside finish*

Sezione ante | Door section:



modulo   module 981 + 981	CODICE CODE	PONTE 4 ANTE da 499 mm SPAN UNIT. w/4 DOORS 499 mm						
	EMMPO380	<b>924</b>	<b>958</b>	<b>1.012</b>	<b>1.192</b>	<b>1.145</b>	<b>1.171</b>	<b>122</b>
modulo   module 1225 + 1225	CODICE CODE	PONTE 4 ANTE da 621 mm SPAN UNIT. w/4 DOORS 621 mm						
	EMMPO390	<b>1.050</b>	<b>1.084</b>	<b>1.162</b>	<b>1.380</b>	<b>1.322</b>	<b>1.356</b>	<b>150</b>

# BATTENTE | REGULAR DOOR

ponete con anta simply | span unit with simply door H. 850

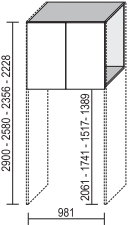
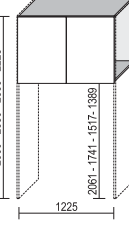
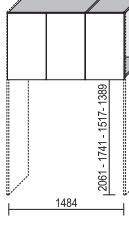
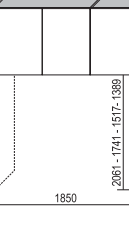
<p>- Aggiungere sempre i fianchi a pag.   Add always side panels on page 24</p> <p>- Prezzi calcolati con interno melaminico. Dotazione interna vano standard: non prevista, possibile inserimento di n. 1 ripiano per modulo.</p> <p>- Prices calculated with melamine inside finish. Standard internal equipment: not included, possible addition of 1 shelf per module.</p> <p>- Anta sempre senza maniglia, la presa avviene sotto l'anta.</p> <p>- Door always without handle, it can be opened from the bottom.</p>		SIMPLY lacc. opaco base basic matt lacq.	SIMPLY lacc. opaco colore colour matt lacq.	SIMPLY essenza wood	SIMPLY rovere lacc. poro aperto open pore lacq. oak	SIMPLY rovere termotrattato heat-treated oak	SIMPLY lacc. lucido glossy lacq.	<p>Maggiorazione per interno laccato opaco</p> <p>Increase for matt lacquered inside finish</p>
		<p>Sezione ante   Door section:</p> 						
<p><b>modulo   module 981</b></p> 	<p>CODICE CODE</p> <p>PONTE 2 ANTE da 499 mm SPAN UNIT. w/2 DOORS 499 mm</p>							
	EMMPO440	<b>539</b>	<b>556</b>	<b>588</b>	<b>687</b>	<b>662</b>	<b>678</b>	<b>57</b>
<p><b>modulo   module 1225</b></p> 	<p>CODICE CODE</p> <p>PONTE 2 ANTE da 621 mm SPAN UNIT. w/2 DOORS 621 mm</p>							
	EMMPO450	<b>605</b>	<b>624</b>	<b>666</b>	<b>789</b>	<b>753</b>	<b>776</b>	<b>71</b>
<p><b>modulo   module 981 + 478</b></p> 	<p>CODICE CODE</p> <p>PONTE 3 ANTE da 499 mm SPAN UNIT. w/3 DOORS 499 mm</p>							
	EMMPO460	<b>799</b>	<b>823</b>	<b>869</b>	<b>1.019</b>	<b>981</b>	<b>1.003</b>	<b>114</b>
<p><b>L. modulo   module 1225 + 600</b></p> 	<p>CODICE CODE</p> <p>PONTE 3 ANTE da 621 mm SPAN UNIT. w/3 DOORS 621 mm</p>							
	EMMPO470	<b>900</b>	<b>928</b>	<b>993</b>	<b>1.178</b>	<b>1.120</b>	<b>1.160</b>	<b>132</b>

# BATTENTE | REGULAR DOOR







ponete con anta simply | span unit with simply door H. 850

- Aggiungere sempre i fianchi a pag. | Add always side panels on page 24

- Prezzi calcolati con interno melaminico. Dotazione interna vano standard: non prevista, possibile inserimento di n. 1 ripiano per modulo.

- Prices calculated with melamine inside finish. Standard internal equipment: not included, possible addition of 1 shelf per module.

- Anta sempre senza maniglia, la presa avviene sotto l'anta.  
- Door always without handle, it can be opened from the bottom.

SIMPLY lacc. opaco base basic matt lacq.	SIMPLY lacc. opaco colore colour matt lacq.	SIMPLY essenza wood	SIMPLY rovere lacc. poro aperto open pore lacq. oak	SIMPLY rovere termotrattato heat-treated oak	SIMPLY lacc. lucido glossy lacq.
					

Maggiorazione per interno laccato opaco

Increase for matt lacquered inside finish



Sezione ante | Door section:

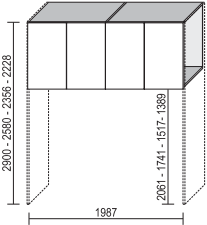
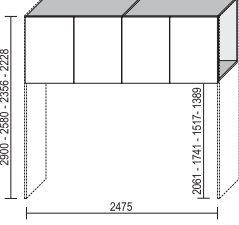

modulo   module 981 + 981	CODICE CODE	PONTE 4 ANTE da 499 mm SPAN UNIT. w/4 DOORS 499 mm						
	EMMPO480	<b>980</b>	<b>1.014</b>	<b>1.076</b>	<b>1.280</b>	<b>1.229</b>	<b>1.259</b>	<b>143</b>
modulo   module 1225 + 1225	CODICE CODE	PONTE 4 ANTE da 621 mm SPAN UNIT. w/4 DOORS 621 mm						
	EMMPO490	<b>1.118</b>	<b>1.156</b>	<b>1.238</b>	<b>1.488</b>	<b>1.410</b>	<b>1.460</b>	<b>171</b>

# BATTENTE | REGULAR DOOR

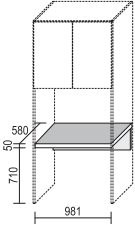
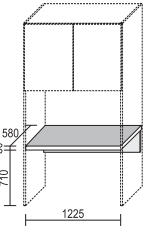
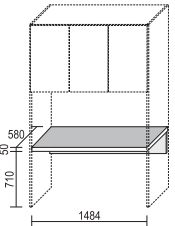
## piani scrivania | writing desk tops

<p>- Il piano scrivania va sempre inserito tra due moduli armadio o sotto un elemento ponte. - The writing desk top is always positioned between two wardrobe modules or below a span unit.</p>	<p>CODICE  CODE</p>	<p>lacc. opaco base  basic matt lacq.</p>	<p>lacc. opaco colore  colour matt lacq.</p>	<p>essenza  wood</p>	<p>rovere lacc. poro aperto  open pore lacq. oak</p>	<p>rovere termotrattato  heat-treated oak</p>	<p>lacc. lucido  glossy lacq.</p>		
<p>PIANO SCRIVANIA da 981 mm   WRITING DESK TOP 981 mm</p> 	<p>EMS20142</p>	<p><b>148</b></p>	<p><b>159</b></p>	<p><b>176</b></p>	<p><b>218</b></p>	<p><b>193</b></p>	<p><b>224</b></p>		
<p>PIANO SCRIVANIA da 1225 mm   WRITING DESK TOP 1225 mm</p> 	<p>EMS20152</p>	<p><b>171</b></p>	<p><b>186</b></p>	<p><b>204</b></p>	<p><b>257</b></p>	<p><b>223</b></p>	<p><b>267</b></p>		
<p>PIANO SCRIVANIA da 1484 mm   WRITING DESK TOP 1484 mm</p> 	<p>EMS20162</p>	<p><b>198</b></p>	<p><b>218</b></p>	<p><b>237</b></p>	<p><b>301</b></p>	<p><b>259</b></p>	<p><b>313</b></p>		
<p>LUCE LED L. 826 per elemento ponte con interruttore touch, compresa di trasformatore LED LIGHT L. 826 for span unit with touch switch, transformer included</p> 	<p>EMXLI343</p>	<p><b>252</b></p>							



# BATTENTE | REGULAR DOOR

cassettiere per scrivania | *drawer units for writing desks*

- La cassetiera è prevista solo con apertura "push pull".  
Disponibile a richiesta con 4 ruote piroettanti H. 45.  
- The drawer unit is provided only with "push pull" opening.  
Available on demand with 4 swivelling wheels H. 45.

CODICE	lacc. opaco	rovere moro	rovere termotrattato	lacc. lucido
CODE	mat lacq.	oak in mahogany finish	heat-treated oak	glossy lacq.

CASSETTIERA 4 cassetti | *DRAWER UNIT with 4 drawers*

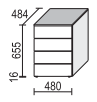

EMXS1423	<b>532</b>	<b>643</b>	<b>727</b>	<b>618</b>
maggiorazione 4 ruote surcharge 4 wheels	<b>25</b>			

CASSETTIERA 2 cassetti e 1 cestone  
*DRAWER UNIT 2 drawers and 1 deep drawer*

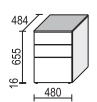

EMXS2423	<b>470</b>	<b>576</b>	<b>651</b>	<b>557</b>
maggiorazione 4 ruote surcharge 4 wheels	<b>25</b>			

CASSETTIERA 2 cestoni | *DRAWER UNIT 2 deep drawers*

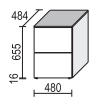

EMXS3423	<b>408</b>	<b>509</b>	<b>575</b>	<b>496</b>
maggiorazione 4 ruote surcharge 4 wheels	<b>25</b>			





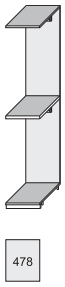
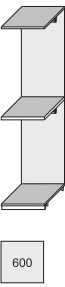
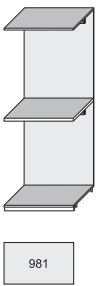
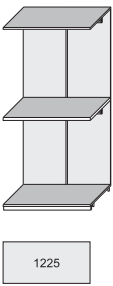

# BATTENTE | REGULAR DOOR

scocche vuote | empty bodies

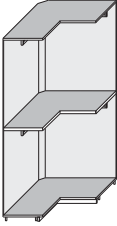
- Fianchi e divisioni a pag.   Side panels and partitions on page 24 - Ante da pag.   Doors on page 68 - Dotazione interna vano standard: N. 1 ripiano - N. 2 tubi appendiabiti - Standard internal equipment: 1 shelf - 2 clothes hangers		CODICE	melaminico magnolia	melaminico decorativo tessuto	melaminico rovere termotrattato	lacc. opaco				
		CODE	magnolia melamine	decorative material melamine	heat-treated oak melamine	mat lacq.				
<b>L. 478</b>  478	H.	CODICE	EL. 1 ANTA da 499 mm - escluso di fianchi, divisioni e ante							
	H.	CODE	EL. w/1 DOOR 499 mm - side panels, partitions and doors not included							
		2228	EMMB0220	160	160	160	226			
		2356	EMMB0320	161	161	161	230			
		2580	EMMB0420	164	164	164	235			
	2900	EMMB0620	167	167	167	245				
<b>L. 600</b>  600	H.	CODICE	EL. 1 ANTA da 621 mm - escluso di fianchi, divisioni e ante							
	H.	CODE	EL. w/1 DOOR 621 mm - side panels, partitions and doors not included							
		2228	EMMB0230	174	174	174	259			
		2356	EMMB0330	176	176	176	264			
		2580	EMMB0430	178	178	178	271			
	2900	EMMB0630	183	183	183	283				
<b>L. 981</b>  981	H.	CODICE	EL. 2 ANTE da 499 mm - escluso di fianchi, divisioni e ante							
	H.	CODE	EL. w/2 DOORS 499 mm - side panels, partitions and doors not included							
		2228	EMMB0250	237	237	237	377			
		2356	EMMB0350	240	240	240	383			
		2580	EMMB0450	244	244	244	393			
	2900	EMMB0650	251	251	251	412				
<b>L. 1225</b>  1225	H.	CODICE	EL. 2 ANTE da 621 mm - escluso di fianchi, divisioni e ante							
	H.	CODE	EL. w/2 DOORS 621 mm - side panels, partitions and doors not included							
		2228	EMMB0260	326	326	326	497			
		2356	EMMB0360	332	332	332	509			
		2580	EMMB0460	339	339	339	526			
	2900	EMMB0660	353	353	353	554				

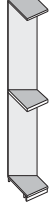
# BATTENTE | REGULAR DOOR

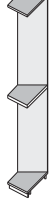
scocche vuote | empty bodies

- Fianchi e divisioni a pag.   Side panels and partitions on page 24 - Ante da pag.   Doors on page 68 - Dotazione interna vano angolo: N. 1 ripiano - N. 2 tubi appendiabiti Dotazione interna vano terminale: - N. 1 ripiano - Corner internal equipment: 1 shelf - 2 clothes hangers End unit internal equipment: - 1 shelf		CODICE	melaminico magnolia	melaminico decorativo tessuto	melaminico rovere termotrattato	lacc. opaco				
		CODE	magnolia melamine	decorative material melamine	heat-treated oak melamine	mat lacq.				
<b>L. 1104</b>  	H.	CODICE	ANGOLO 2 ANTE da 499 mm - escluso di fianchi, divisioni e ante							
	H.	CODE	CORNER w/2 DOORS 499 mm - side panels, partitions and doors not included							
		2228	EMMA0210	<b>551</b>	<b>551</b>	<b>551</b>	<b>832</b>			
		2356	EMMA0310	<b>560</b>	<b>560</b>	<b>560</b>	<b>848</b>			
		2580	EMMA0410	<b>571</b>	<b>571</b>	<b>571</b>	<b>872</b>			
	2900	EMMA0610	<b>598</b>	<b>598</b>	<b>598</b>	<b>925</b>				
<b>L. 421</b>  	H.	CODICE	TERMINALE DX 1 ANTA da 499 mm - escluso di fianchi, divisioni e ante							
	H.	CODE	RH END UNIT w/1 DOOR 499 mm - side panels, partitions and doors not included							
		2228	EMMT0210	<b>178</b>	<b>178</b>	<b>178</b>	<b>240</b>			
		2356	EMMT0310	<b>180</b>	<b>180</b>	<b>180</b>	<b>244</b>			
		2580	EMMT0410	<b>181</b>	<b>181</b>	<b>181</b>	<b>249</b>			
	2900	EMMT0610	<b>187</b>	<b>187</b>	<b>187</b>	<b>258</b>				
<b>L. 421</b>  	H.	CODICE	TERMINALE SX 1 ANTA da 499 mm - escluso di fianchi, divisioni e ante							
	H.	CODE	LH END UNIT w/1 DOOR 499 mm - side panels, partitions and doors not included							
		2228	EMMT0210	<b>178</b>	<b>178</b>	<b>178</b>	<b>240</b>			
		2356	EMMT0310	<b>180</b>	<b>180</b>	<b>180</b>	<b>244</b>			
		2580	EMMT0410	<b>181</b>	<b>181</b>	<b>181</b>	<b>249</b>			
	2900	EMMT0610	<b>187</b>	<b>187</b>	<b>187</b>	<b>258</b>				

# BATTENTE | REGULAR DOOR

abaco ante superficie termoformata | *thermoformed surface doors list*

- Maniglie a pag. 17  
- Handles on page 17

CODICE	superficie termoformata	lacc. opaco base	lacc. opaco colore
CODE	thermoformed surface	basic matt lacq.	colour matt lacq.

**BASIC** L. 499 mm



H.	CODICE	ANTA <b>DX</b> O <b>SX</b> - DA SPECIFICARE NELL'ORDINE <i>RH OR LH DOOR - TO BE SPECIFIED IN THE ORDER</i>						
H.	CODE							

2208	EMA04126	<b>135</b>		<b>218</b>				
2336	EMA04127	<b>144</b>		<b>227</b>				
2560	EMA04128	<b>152</b>		<b>235</b>				

**ASOLA** L. 499 mm

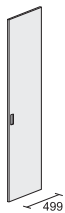

H.	CODICE	ANTA SOLO <b>DX</b> <i>ONLY RH DOOR</i>						
H.	CODE							

2208	EMA05126	<b>161</b>						
2336	EMA05127	<b>171</b>						
2560	EMA05128	<b>182</b>						

**LINEAR** L. 499 mm

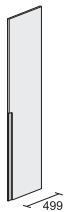

H.	CODICE	ANTA SOLO <b>DX</b> <i>ONLY RH DOOR</i>						
H.	CODE							

2208	EMA07126	<b>151</b>		<b>234</b>				
2336	EMA07127	<b>160</b>		<b>243</b>				
2560	EMA07128	<b>171</b>		<b>254</b>				

**DESIGN** L. 499 mm

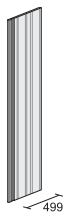



H.	CODICE	ANTA <b>DX</b> O <b>SX</b> - DA SPECIFICARE NELL'ORDINE <i>RH OR LH DOOR - TO BE SPECIFIED IN THE ORDER</i>						
H.	CODE							

2208	EMA10126	<b>174</b>						
2336	EMA10127	<b>185</b>						
2560	EMA10128	<b>196</b>						



# BATTENTE | REGULAR DOOR

## abaco ante simply | simply doors list

<ul style="list-style-type: none"> <li>- Maniglie a pag.   <i>Handles on page 17</i></li> <li>- L'anta simply vetro è disponibile solo con maniglia Gamma.</li> <li>- <i>The simply vetro door is only available with Gamma handle.</i></li> </ul>		CODICE	lacc. opaco base	lacc. opaco colore	essenza	rovere lacc. poro aperto	rovere termotrattato	lacc. lucido	vetro cat.1 int. lacc. opaco	vetro cat.2 int. lacc. opaco
		CODE	basic matt lacq.	colour matt lacq.	wood	open pore lacq. oak	heat-treated oak	glossy lacq.	glass cat.1 inside matt lacq.	glass cat.2 inside matt lacq.
<b>- CATEGORIA VETRI   GLASSES CATEGORY:</b> <b>Cat. 1:</b> sabbia chiaro, sabbia scuro, corda, grigio pietra, grigio chiaro, grigio medio, grigio polvere, blu piombo, giallo cromo, verde pompelmo, rosso rubino, nero, stopsol fumé, specchio, specchio bronzo, specchio fumo. <b>- Cat. 1:</b> light sand, dark sand, rope, stone grey, light grey, medium grey, powder grey, gun metal blue, chrome yellow, green grapefruit, ruby red, black, smoke-grey stopsol, mirror, bronze mirror, smoke mirror. <b>- Cat. 2:</b> bianco, magnolia   white, magnolia.										
<b>SIMPLY - SIMPLY VETRO L. 499 mm</b> 		H. H.	CODICE ANTA <b>DX</b> O <b>SX</b> - DA SPECIFICARE NELL'ORDINE CODE <i>RH</i> OR <i>LH</i> DOOR - TO BE SPECIFIED IN THE ORDER							
	2208	EMA00226	<b>148</b>	<b>172</b>	<b>209</b>	<b>274</b>	<b>270</b>	<b>285</b>	<b>288</b>	<b>379</b>
	2336	EMA00227	<b>156</b>	<b>179</b>	<b>222</b>	<b>290</b>	<b>286</b>	<b>302</b>	<b>300</b>	<b>388</b>
	2560	EMA00228	<b>165</b>	<b>191</b>	<b>236</b>	<b>312</b>	<b>304</b>	<b>325</b>	<b>323</b>	<b>420</b>
	2880	EMA00229	<b>189</b>	<b>219</b>	<b>265</b>	<b>349</b>	<b>342</b>	<b>365</b>		
<b>SIMPLY - SIMPLY VETRO L. 621 mm</b> 		H. H.	CODICE ANTA <b>DX</b> O <b>SX</b> - DA SPECIFICARE NELL'ORDINE CODE <i>RH</i> OR <i>LH</i> DOOR - TO BE SPECIFIED IN THE ORDER							
	2208	EMA00256	<b>172</b>	<b>200</b>	<b>242</b>	<b>324</b>	<b>313</b>	<b>338</b>	<b>338</b>	<b>451</b>
	2336	EMA00257	<b>180</b>	<b>209</b>	<b>257</b>	<b>343</b>	<b>331</b>	<b>359</b>	<b>351</b>	<b>462</b>
	2560	EMA00258	<b>193</b>	<b>224</b>	<b>277</b>	<b>370</b>	<b>357</b>	<b>388</b>	<b>379</b>	<b>500</b>
	2880	EMA00259	<b>221</b>	<b>257</b>	<b>311</b>	<b>416</b>	<b>401</b>	<b>437</b>		

# BATTENTE | REGULAR DOOR

abaco ante tecno | *tecno doors list*

- Maniglia inserita per tutta la lunghezza dell'anta: disponibile in finitura bianco, con maggiorazione di <b>30 euro</b> per la finitura brill spazzolato e laccato opaco colore (da specificare nell'ordine). - Handle built-in along the length of the door, available in white finish, with increase of <b>30 euros</b> for the brushed brill finish and matt lacquer colour (to be specified in the order). - CATEGORIA VETRI   GLASSES CATEGORY: Cat. 1: sabbia chiaro, sabbia scuro, corda, grigio pietra, grigio chiaro, grigio medio, grigio polvere, blu piombo, giallo cromo, verde pompelmo, rosso rubino, nero, stopsol fumé, specchio, specchio bronzo, specchio fumo. - Cat. 1: light sand, dark sand, rope, stone grey, light grey, medium grey, powder grey, gun metal blue, chrome yellow, green grapefruit, ruby red, black, smoke-grey stopsol, mirror, bronze mirror, smoke mirror. - Cat. 2: bianco, magnolia   white, magnolia.		CODICE	lacc. opaco base	lacc. opaco colore	essenza	rovere lacc. poro aperto	rovere termotrattato	lacc. lucido	vetro cat.1 int. lacc. opaco	vetro cat.2 int. lacc. opaco
		CODE	basic matt lacq.	colour matt lacq.	wood	open pore lacq. oak	heat-treated oak	glossy lacq.	glass cat.1 inside matt lacq.	glass cat.2 inside matt lacq.
<b>TECNO - TECNO VETRO L. 377 mm</b> 	H. H.	CODICE CODE	ANTA SOLO <b>DX</b> ONLY <b>RH</b> DOOR							
		2208 EMA02206	<b>146</b>	<b>164</b>	<b>195</b>	<b>240</b>	<b>236</b>	<b>257</b>	<b>253</b>	<b>315</b>
		2336 EMA02207	<b>152</b>	<b>172</b>	<b>207</b>	<b>254</b>	<b>250</b>	<b>273</b>	<b>266</b>	<b>325</b>
		2560 EMA02208	<b>161</b>	<b>181</b>	<b>220</b>	<b>271</b>	<b>265</b>	<b>292</b>	<b>282</b>	<b>346</b>
		2880 EMA02209	<b>183</b>	<b>206</b>	<b>249</b>	<b>308</b>	<b>301</b>	<b>331</b>		
<b>TECNO - TECNO VETRO L. 499 mm</b> 	H. H.	CODICE CODE	ANTA <b>DX</b> O <b>SX</b> - DA SPECIFICARE NELL'ORDINE <b>RH</b> OR <b>LH</b> DOOR - TO BE SPECIFIED IN THE ORDER							
		2208 EMA02226	<b>195</b>	<b>223</b>	<b>264</b>	<b>328</b>	<b>319</b>	<b>354</b>	<b>330</b>	<b>414</b>
		2336 EMA02227	<b>203</b>	<b>227</b>	<b>278</b>	<b>345</b>	<b>336</b>	<b>368</b>	<b>342</b>	<b>421</b>
		2560 EMA02228	<b>213</b>	<b>241</b>	<b>295</b>	<b>368</b>	<b>356</b>	<b>392</b>	<b>365</b>	<b>452</b>
		2880 EMA02229	<b>242</b>	<b>273</b>	<b>334</b>	<b>418</b>	<b>404</b>	<b>445</b>		
<b>TECNO - TECNO VETRO L. 621 mm</b> 	H. H.	CODICE CODE	ANTA <b>DX</b> O <b>SX</b> - DA SPECIFICARE NELL'ORDINE <b>RH</b> OR <b>LH</b> DOOR - TO BE SPECIFIED IN THE ORDER							
		2208 EMA02256	<b>218</b>	<b>246</b>	<b>296</b>	<b>372</b>	<b>358</b>	<b>400</b>	<b>378</b>	<b>483</b>
		2336 EMA02257	<b>227</b>	<b>257</b>	<b>314</b>	<b>394</b>	<b>380</b>	<b>425</b>	<b>392</b>	<b>493</b>
		2560 EMA02258	<b>241</b>	<b>273</b>	<b>333</b>	<b>421</b>	<b>403</b>	<b>454</b>	<b>420</b>	<b>530</b>
		2880 EMA02259	<b>273</b>	<b>310</b>	<b>378</b>	<b>478</b>	<b>457</b>	<b>516</b>		



# ANTA BATTENTE CUBO | REGULAR DOOR CUBO

componibilità orizzontale | horizontal modularity

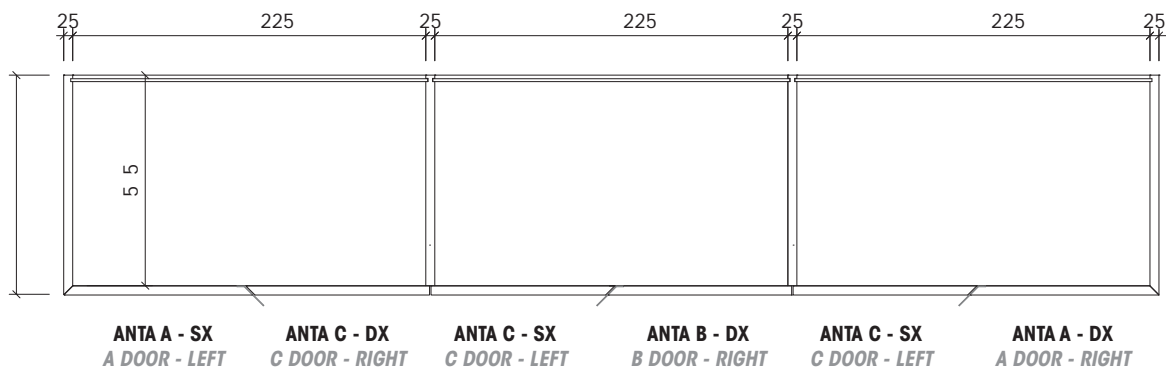
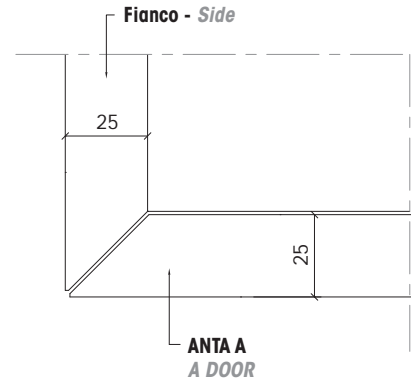

larghezza length		larghezza length		larghezza length	
2037		3287		4537	
2281		3531		5025	
2525		3775			
3043		4049			



# ANTA BATTENTE CUBO | REGULAR DOOR CUBO

tipologia di ante | doors type

## CASSETTIERE armadio CUBO | DRAWER UNITS FOR CUBO wardrobe

### ARMADIO CUBO - CUBO WARDROBE

Impossibile utilizzare una cassettera su tutto il vano laterale. Le cerniere dell'anta laterale -A- impediscono l'uscita del cassetto.

*A drawer unit cannot be used on the whole width of the side compartment. The hinges on side door -A- prevent the drawer from opening.*

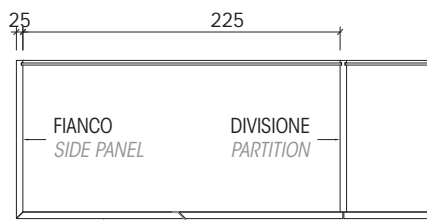
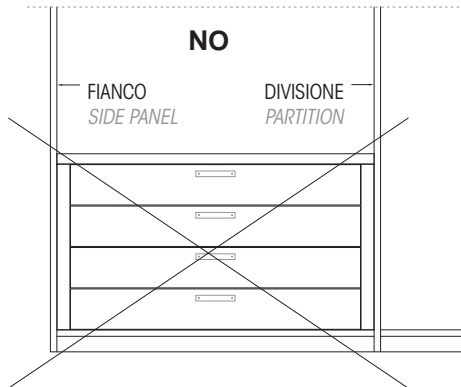

**ANTA LATERALE -A-  
SIDE DOOR -A-**

### ARMADIO CUBO - CUBO WARDROBE

L'alternativa è quella di utilizzare una cassettera più piccola appoggiata sul lato divisione.

*As an alternative, fit a smaller drawer unit on the partition side.*

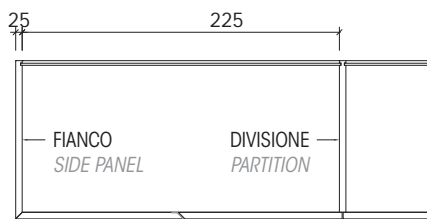
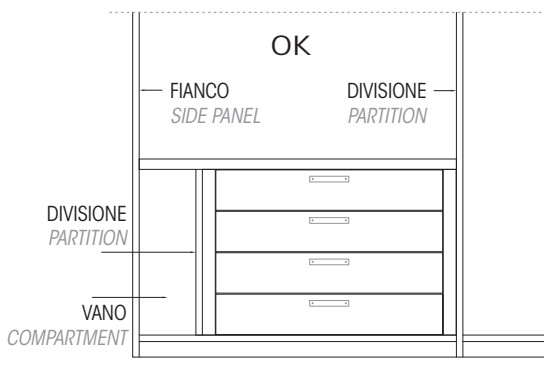

**ANTA LATERALE -A-  
SIDE DOOR -A-**

## CUBO A anta battente | regular door

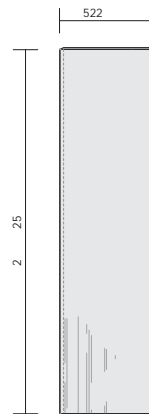

sezione | section



dx | rh      sx | lh

### FINITURE PANNELLO | PANEL FINISHES

- laccato opaco, laccato lucido, rovere termotrattato, rovere nodi  
- *Matt lacquered, glossy lacquered, heat-treated oak, oak knots\*\**

### CARATTERISTICHE TECNICHE | TECHNICAL CHARACTERISTICS

Pannello di particelle di legno di classe E1 sp. 25 mm  
impiallacciato rovere nodi e rovere termotrattato, laccato opaco - laccato lucido  
*25mm thick Class E1 wood particle board panel coated with oak knots, heat-treated oak, matt lacquered or glossy lacquered*

### FINITURA MANIGLIA | HANDLE FINISH

laccato opaco - *Matt lacquered*

### ATTENZIONE | ATTENTION

La maniglia è già compresa nell'anta - *The handle is included in the door*

\*\* disponibile in tutta la gamma colori | *available in the whole colour range*

# ANTA BATTENTE CUBO | REGULAR DOOR CUBO

tipologia di ante | door type

## CUBO B anta battente | regular door

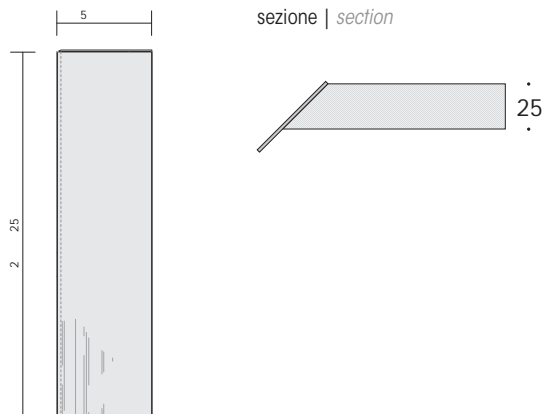

dx | rh      sx | lh

### FINITURE PANNELLO | PANEL FINISHES

- laccato opaco, laccato lucido, rovere termotrattato, rovere nodi \*\*  
- *Matt lacquered, glossy lacquered, heat-treated oak, oak knots \*\**

### CARATTERISTICHE TECNICHE | TECHNICAL CHARACTERISTICS

Pannello di particelle di legno di classe E1 sp. 25 mm  
impiallacciato rovere nodi e rovere termotrattato, laccato opaco - laccato lucido  
*25mm thick Class E1 wood particle board panel coated with oak knots, heat-treated oak, matt lacquered or glossy lacquered*

### FINITURA MANIGLIA | HANDLE FINISH

laccato opaco - *Matt lacquered*

### ATTENZIONE | ATTENTION

La maniglia è già compresa nell'anta - *The handle is included in the door*

## CUBO C anta battente | regular door

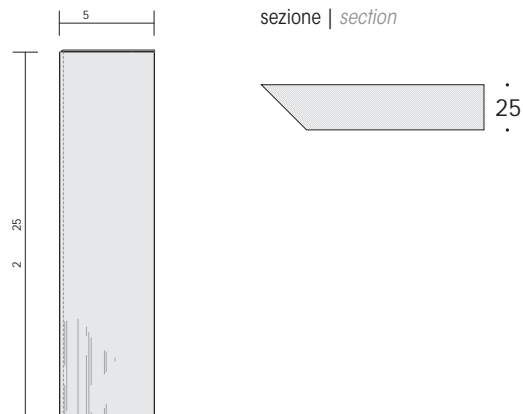

dx | rh      sx | lh

### FINITURE PANNELLO | PANEL FINISHES

- laccato opaco, laccato lucido, rovere termotrattato, rovere nodi \*\*  
- *Matt lacquered, glossy lacquered, heat-treated oak, oak knots\*\**

### CARATTERISTICHE TECNICHE | TECHNICAL CHARACTERISTICS





Pannello di particelle di legno di classe E1 sp. 25 mm  
impiallacciato rovere nodi e rovere termotrattato, laccato opaco - laccato lucido  
*25mm thick Class E1 wood particle board panel coated with oak knots, heat-treated oak, matt lacquered or glossy lacquered*

### ATTENZIONE | ATTENTION



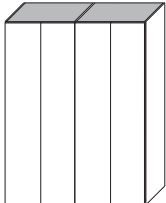
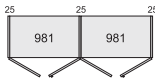
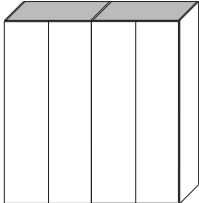

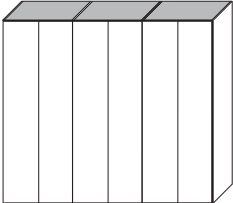
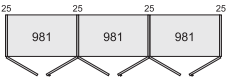
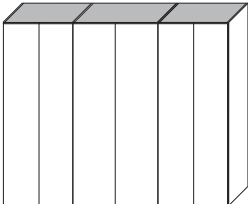
L'anta non necessita di maniglia - *This door doesn't require any kind of handle.*

\*\* disponibile in tutta la gamma colori | available in the whole colour range

# ANTA BATTENTE CUBO | REGULAR DOOR CUBO

<p>- <b>Attenzione: la finitura dei fianchi segue la finitura dell'anta</b>                      - <i>Attention: the finish of the sides matches the finish of the door</i></p> <p>- <b>Prezzi calcolati con interno melaminico.</b>                      Dotazione interna vano standard: - N. 1 ripiano - N. 2 tubi appendiabiti                      - <i>Prices calculated with melamine inside finish.</i>                      Standard internal equipment: - 1 shelf - 2 clothes hangers</p> <p>- <b>Per i prezzi delle componibilità previste a pag. 72 ma non riportate di seguito, rivolgersi all'ufficio commerciale.</b>                      - <i>Consult our sales office for prices related to the combinations of items shown on page 72 but not listed below.</i></p>			CUBO laccato opaco base <i>basic matt lacq.</i>	CUBO laccato opaco colore <i>colour matt lacquered</i>	CUBO laccato lucido <i>glossy lacquered</i>	CUBO rovere nodi <i>oak knots</i>	CUBO rovere termotrattato <i>heat-treated oak</i>	Maggiorazione per interno laccato opaco  <i>Surcharge for matt lacquered inside finish</i>		
<p><b>L. 2037</b></p>  			H. H.	CODICE CODE	EL. 4 ANTE EL. w/4 DOORS					
			2356	EMAB3203	<b>1.920</b>	<b>2.000</b>	<b>2.524</b>	<b>2.524</b>	<b>3.096</b>	<b>455</b>
			2580	EMAB4203	<b>1.998</b>	<b>2.082</b>	<b>2.650</b>	<b>2.642</b>	<b>3.258</b>	<b>484</b>
<p><b>L. 2525</b></p>  			H. H.	CODICE CODE	EL. 4 ANTE EL. w/4 DOORS					
			2356	EMAB3233	<b>2.206</b>	<b>2.296</b>	<b>2.902</b>	<b>2.866</b>	<b>3.530</b>	<b>523</b>
			2580	EMAB4233	<b>2.290</b>	<b>2.386</b>	<b>3.046</b>	<b>2.992</b>	<b>3.712</b>	<b>560</b>
<p><b>L. 3043</b></p>  			H. H.	CODICE CODE	EL. 6 ANTE EL. w/6 DOORS					
			2356	EMAB3303	<b>2.740</b>	<b>2.844</b>	<b>3.541</b>	<b>3.539</b>	<b>4.331</b>	<b>679</b>
			2580	EMAB4303	<b>2.847</b>	<b>2.957</b>	<b>3.714</b>	<b>3.697</b>	<b>4.555</b>	<b>723</b>
<p><b>L. 3287</b></p>  			H. H.	CODICE CODE	EL. 6 ANTE EL. w/6 DOORS					
			2356	EMAB3323	<b>2.883</b>	<b>2.992</b>	<b>3.730</b>	<b>3.710</b>	<b>4.548</b>	<b>713</b>
			2580	EMAB4323	<b>2.993</b>	<b>3.109</b>	<b>3.911</b>	<b>3.874</b>	<b>4.782</b>	<b>761</b>

# ANTA BATTENTE CUBO | REGULAR DOOR CUBO

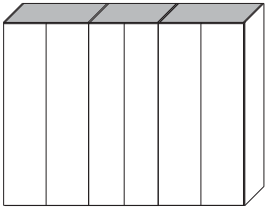
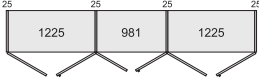
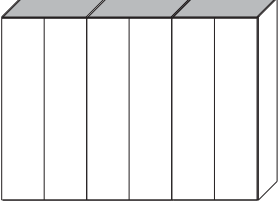
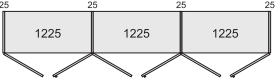
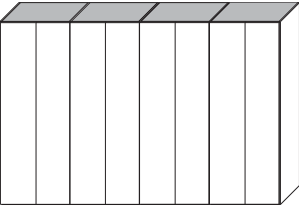
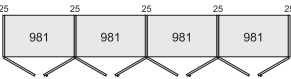
<p>- <b>Attenzione: la finitura dei fianchi segue la finitura dell'anta</b>                      - <i>Attention: the finish of the sides matches the finish of the door</i></p> <p>- <b>Prezzi calcolati con interno melaminico.</b>                      Dotazione interna vano standard: - N. 1 ripiano - N. 2 tubi appendiabiti                      - <i>Prices calculated with melamine inside finish.</i>                      Standard internal equipment: - 1 shelf - 2 clothes hangers</p> <p>- <b>Per i prezzi delle componibilità previste a pag. 72</b>                      ma non riportate di seguito, rivolgersi all'ufficio commerciale.                      - <i>Consult our sales office for prices related to the combinations of items shown on page 72 but not listed below.</i></p>			<p><b>CUBO</b>                      laccato opaco base  <i>basic matt lacq.</i></p> 	<p><b>CUBO</b>                      laccato opaco colore  <i>colour matt lacquered</i></p> 	<p><b>CUBO</b>                      laccato lucido  <i>glossy lacquered</i></p> 	<p><b>CUBO</b>                      rovere nodi  <i>oak knots</i></p> 	<p><b>CUBO</b>                      rovere termotrattato  <i>heat-treated oak</i></p> 	<p>Maggiorazione per interno laccato opaco                       Surcharge for matt lacquered inside finish</p>		
<p><b>L. 3531</b></p>  	<p>H. H.</p>	<p>CODICE CODE</p>	<p>EL. 6 ANTE EL. w/6 DOORS</p>							
			2356	EMAB3333	<b>3.026</b>	<b>3.140</b>	<b>3.919</b>	<b>3.881</b>	<b>4.765</b>	<b>747</b>
			2580	EMAB4333	<b>3.139</b>	<b>3.261</b>	<b>4.110</b>	<b>4.047</b>	<b>5.009</b>	<b>799</b>
<p><b>L. 3775</b></p>  	<p>H. H.</p>	<p>CODICE CODE</p>	<p>EL. 6 ANTE EL. w/6 DOORS</p>							
			2356	EMAB3363	<b>3.169</b>	<b>3.288</b>	<b>4.108</b>	<b>4.052</b>	<b>4.982</b>	<b>781</b>
			2580	EMAB4363	<b>3.285</b>	<b>3.413</b>	<b>4.307</b>	<b>4.224</b>	<b>5.236</b>	<b>837</b>
<p><b>L. 4049</b></p>  	<p>H. H.</p>	<p>CODICE CODE</p>	<p>EL. 8 ANTE EL. w/8 DOORS</p>							
			2356	EMAB3400	<b>3.560</b>	<b>3.688</b>	<b>4.558</b>	<b>4.554</b>	<b>5.566</b>	<b>903</b>
			2580	EMAB4400	<b>3.696</b>	<b>3.832</b>	<b>4.778</b>	<b>4.752</b>	<b>5.852</b>	<b>962</b>

# BATTENTE | REGULAR DOOR

## composizioni fotografiche | photo compositions

**DOTAZIONE INTERNA VANO STANDARD: N. 1 ripiano, N. 2 tubi appendiabiti** | **STANDARD INTERNAL EQUIPMENT: 1 shelf, 2 clothes hangers**

### COMPOSIZIONE | COMPOSITION 1

L. 3043 H. 2580 P. | D. 608

**€ 2.011,00** prezzo: esterno come foto; interno con dotazione standard  
*price: outside as per photo; inside as per standard equipment*

- ANTE SPRINT  
- SPRINT DOORS
- FIANCHI  
- SIDES
- STRUTTURA INTERNA  
- INTERNAL STRUCTURE
- MANIGLIA OMEGA  
- OMEGA HANDLE
- melaminico materico olmo beige  
- textured melamine beige elm
- melaminico materico olmo beige  
- textured melamine beige elm
- melaminico  
- melamine
- laccata opaca canapa  
- hemp matt lacquered

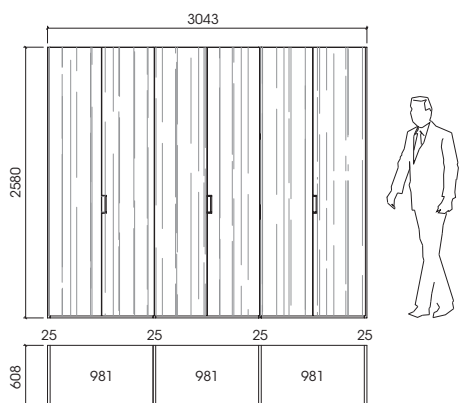

### COMPOSIZIONE | COMPOSITION 2

L. 3043 H. 2580 P. | D. 608

**€ 1.957,00** prezzo: esterno come foto; interno con dotazione standard  
*price: outside as per photo; inside as per standard equipment*

- ANTE SX SPRINT  
- SPRINT LH DOORS
- ANTE DX SPRINT PLUS  
- SPRINT PLUS RH DOORS
- FIANCHI  
- SIDES
- STRUTTURA INTERNA  
- INTERNAL STRUCTURE
- melaminico materico olmo bianco  
- textured melamine white elm
- melaminico materico olmo bianco maniglia ricavata  
- textured melamine white elm with built-in handle
- melaminico materico olmo bianco  
- textured melamine white elm
- melaminico  
- melamine

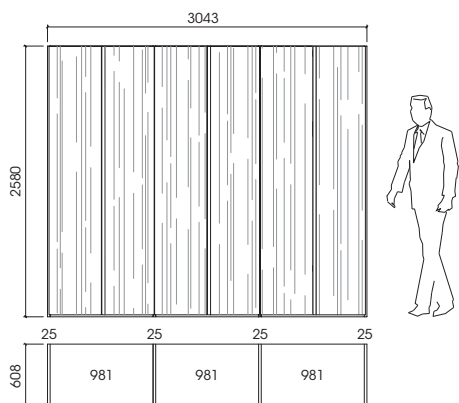

### COMPOSIZIONE | COMPOSITION 3

L. 4049 H. 2580 P. | D. 608

**€ 2.566,00** prezzo: esterno come foto; interno con dotazione standard  
*price: outside as per photo; inside as per standard equipment*

- ANTE SX SPRINT  
- SPRINT LH DOORS
- ANTE DX SPRINT PLUS  
- SPRINT PLUS RH DOORS
- FIANCHI  
- SIDES
- STRUTTURA INTERNA  
- INTERNAL STRUCTURE
- melaminico materico olmo taupe  
- textured melamine taupe elm
- melaminico materico olmo taupe maniglia ricavata  
- textured melamine taupe elm with built-in handle
- melaminico materico olmo taupe  
- textured melamine taupe elm
- melaminico  
- melamine

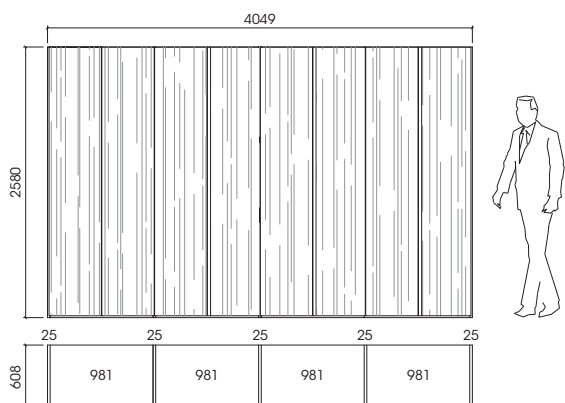

# BATTENTE | REGULAR DOOR

## composizioni fotografiche | photo compositions

DOTAZIONE INTERNA VANO STANDARD: N. 1 ripiano, N. 2 tubi appendiabiti | STANDARD INTERNAL EQUIPMENT: 1 shelf, 2 clothes hangers

### COMPOSIZIONE | COMPOSITION 4

L. 4049 H. 2580 P. | D. 608

**€ 2.824,00** prezzo: esterno come foto; interno con dotazione standard  
*price: outside as per photo; inside as per standard equipment*

- ANTE SX BASIC
- BASIC LH DOORS
- ANTE DX ASOLA
- ASOLA RH DOORS
- FIANCHI
- SIDES
- STRUTTURA INTERNA
- INTERNAL STRUCTURE
- superficie termoformata bianco
- white thermoformed surface
- superficie termoformata bianco maniglia ricavata
- white thermoformed surface with built-in handle
- laccato opaco bianco 9003
- matt lacquer white 9003
- melaminico
- melamine

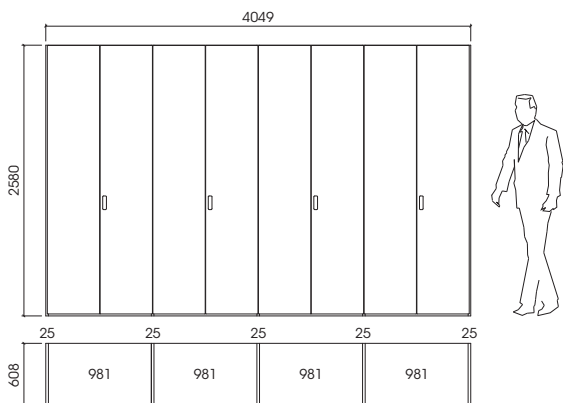

### COMPOSIZIONE | COMPOSITION 5

L. 4049 H. 2580 P. | D. 608

**€ 2.780,00** prezzo: esterno come foto; interno con dotazione standard  
*price: outside as per photo; inside as per standard equipment*

- ANTE SX BASIC
- BASIC LH DOORS
- ANTE DX LINEAR
- LINEAR RH DOORS
- FIANCHI
- SIDES
- STRUTTURA INTERNA
- INTERNAL STRUCTURE
- superficie termoformata bianco
- white thermoformed surface
- superficie termoformata bianco maniglia laterale ricavata
- white thermoformed surface with built-in side handle
- laccato opaco bianco 9003
- matt lacquered white 9003
- melaminico
- melamine

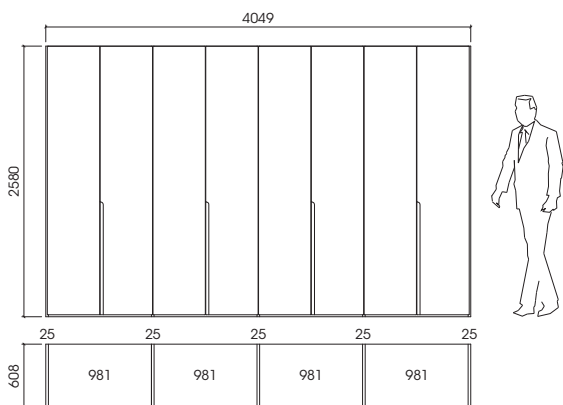

### COMPOSIZIONE | COMPOSITION 6

L. 4049 H. 2580 P. | D. 608

**€ 3.056,00** prezzo: esterno come foto; interno con dotazione standard  
*price: outside as per photo; inside as per standard equipment*

- ANTE DESIGN
- DESIGN DOORS
- FIANCHI
- SIDES
- STRUTTURA INTERNA
- INTERNAL STRUCTURE
- superficie termoformata bianco maniglia laterale ricavata
- white thermoformed surface with built-in side handle
- laccato opaco bianco 9003
- matt lacquered white 9003
- melaminico
- melamine

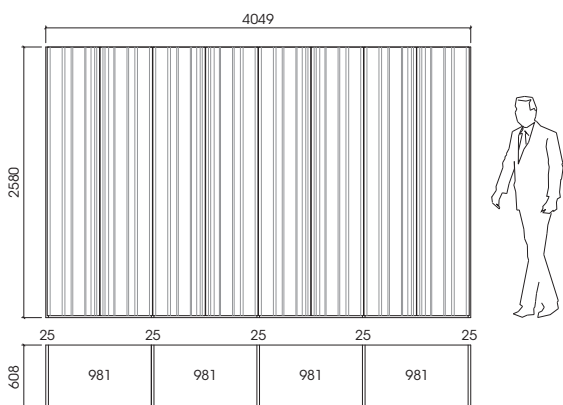

# BATTENTE | REGULAR DOOR

## composizioni fotografiche | photo compositions

**DOTAZIONE INTERNA VANO STANDARD: N. 1 ripiano, N. 2 tubi appendiabiti** | **STANDARD INTERNAL EQUIPMENT: 1 shelf, 2 clothes hangers**

### COMPOSIZIONE | COMPOSITION 7

L. 4049 H. 2580 P. | D. 611

**€ 4.550,00** prezzo: esterno come foto; interno con dotazione standard  
*price: outside as per photo; inside as per standard equipment*

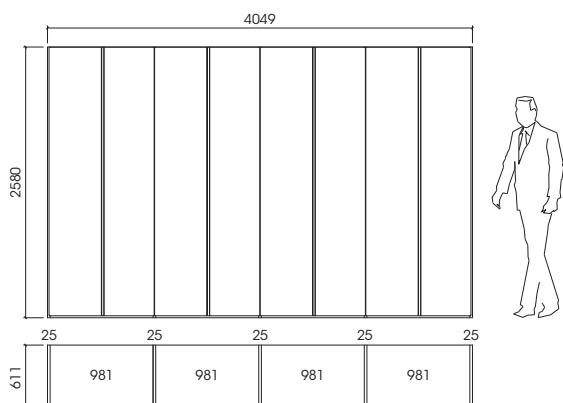

- |   |  |
|---|--|
| - ANTE SX SIMPLY<br>- SIMPLY LH DOORS       | - laccato lucido bianco 9003<br>- glossy lacquered white 9003  |
| - ANTE DX TECNO<br>- TECNO RH DOORS         | - laccato lucido bianco 9003<br>- glossy lacquered white 9003  |
| - FIANCHI<br>- SIDES                        | - laccato lucido bianco 9003<br>- glossy lacquered white 9003  |
| - STRUTTURA INTERNA<br>- INTERNAL STRUCTURE | - melaminico<br>- melamine   |
| - MANIGLIA TECNO<br>- TECNO HANDLE          | - laccato opaco bianco 9003 (già inserita nell'anta)<br>- matt lacquered white 9003 (already included in the door) |

### COMPOSIZIONE | COMPOSITION 8

L. 3668 H. 2580 P. | D. 611

**€ 3.359,00** prezzo: esterno come foto; interno con dotazione standard  
*price: outside as per photo; inside as per standard equipment*

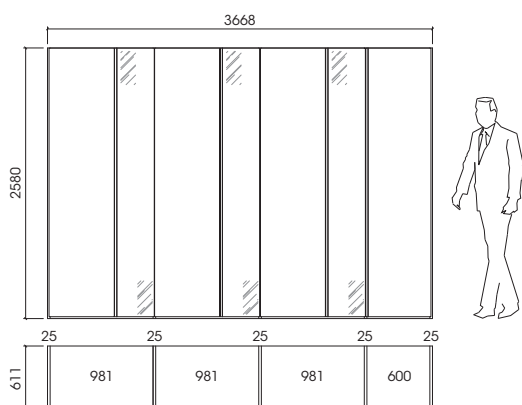

- |   |  |
|---|--|
| - ANTE SX SIMPLY<br>- SIMPLY LH DOORS           | - laccato opaco grigio chiaro 7035<br>- matt lacquered light grey 7035   |
| - ANTE DX TECNO VETRO<br>- TECNO VETRO RH DOORS | - laccato opaco grigio chiaro 7035 con specchio<br>- matt lacquered light grey 7035 with mirror                                |
| - ANTE DX TECNO<br>- TECNO RH DOORS             | - laccato opaco grigio chiaro 7035<br>- matt lacquered light grey 7035   |
| - FIANCHI<br>- SIDES                            | - laccato opaco grigio chiaro 7035<br>- matt lacquered light grey 7035   |
| - STRUTTURA INTERNA<br>- INTERNAL STRUCTURE     | - melaminico<br>- melamine   |
| - MANIGLIA TECNO<br>- TECNO HANDLE              | - laccato opaco grigio chiaro 7035 (già inserita nell'anta)<br>- matt lacquered light grey 7035 (already included in the door) |

### COMPOSIZIONE | COMPOSITION 9

L. 4049 H. 2580 P. | D. 611

**€ 4.524,00** prezzo: esterno come foto; interno con dotazione standard  
*price: outside as per photo; inside as per standard equipment*

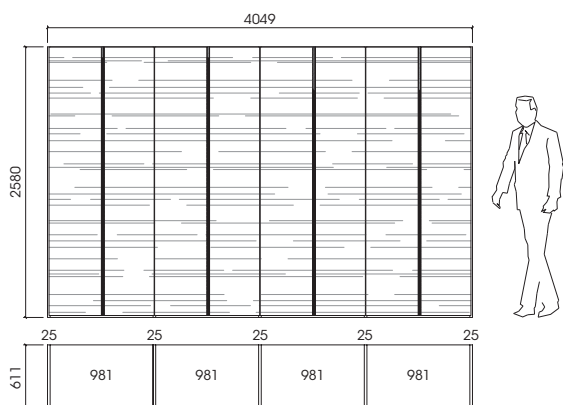

- |   |   |
|---|---|
| - ANTE SX SIMPLY<br>- SIMPLY LH DOORS       | - laccato rovere poro aperto light grey y18231<br>- matt lacquered open-pore oak light grey y18231                            |
| - ANTE DX TECNO<br>- TECNO RH DOORS         | - laccato rovere poro aperto light grey y18231<br>- matt lacquered open-pore oak light grey y18231                            |
| - FIANCHI<br>- SIDES                        | - laccato rovere poro aperto light grey y18231<br>- matt lacquered open-pore oak light grey y18231                            |
| - STRUTTURA INTERNA<br>- INTERNAL STRUCTURE | - melaminico<br>- melamine  |
| - MANIGLIA TECNO<br>- TECNO HANDLE          | - laccato opaco dark grey y18232 (già inserita nell'anta)<br>- matt lacquered dark grey y18232 (already included in the door) |

# BATTENTE | *REGULAR DOOR*

## composizioni fotografiche | *photo compositions*

**DOTAZIONE INTERNA VANO STANDARD: N. 1 ripiano, N. 2 tubi appendiabiti** | **STANDARD INTERNAL EQUIPMENT: 1 shelf, 2 clothes hangers**

### COMPOSIZIONE | *COMPOSITION 10*

L. 4049 H. 2580 P. | D. 611

**€ 4.176,00** prezzo: esterno come foto; interno con dotazione standard  
*price: outside as per photo; inside as per standard equipment*

- ANTE SIMPLY - *SIMPLY DOORS* - laccato opaco light grey y18231 - *matt lacquered light grey y18231*
- FIANCHI - *SIDES* - laccato opaco light grey y18231 - *matt lacquered light grey y18231*
- STRUTTURA INTERNA - *INTERNAL STRUCTURE* - laccato opaco light grey y18231 - *matt lacquered light grey y18231*
- MANIGLIA ALFA - *ALFA HANDLE* - nichel satinato - *satin nickel*

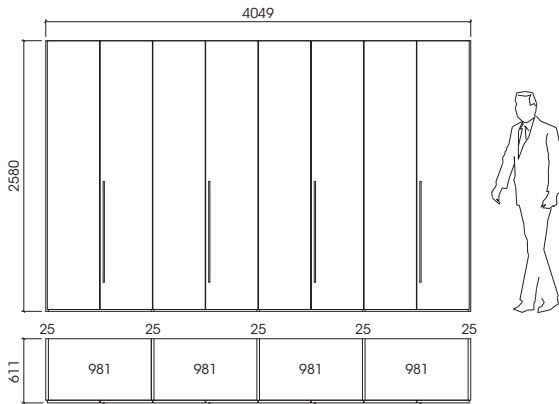

### COMPOSIZIONE | *COMPOSITION 11*

L. 3043 H. 2580 P. | D. 611

**€ 2.380,00** prezzo: esterno come foto; interno con dotazione standard  
*price: outside as per photo; inside as per standard equipment*

- ANTE SIMPLY - *SIMPLY DOORS* - laccato opaco bianco 9003 - *matt lacquered white 9003*
- FIANCHI - *SIDES* - laccato opaco bianco 9003 - *matt lacquered white 9003*
- STRUTTURA INTERNA - *INTERNAL STRUCTURE* - melaminico - *melamine*
- MANIGLIA DELTA - *DELTA HANDLE* - laccato opaco blu piombo 255 - *matt lacquered gun metal blue 255*

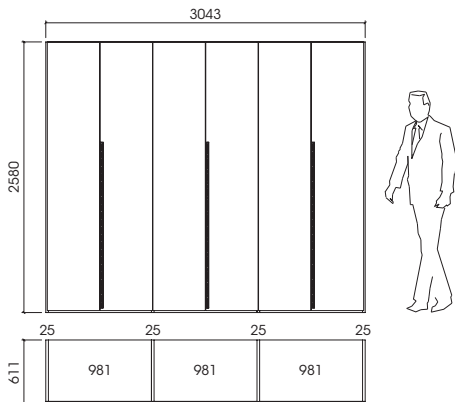

### COMPOSIZIONE | *COMPOSITION 12*

L. 3043 H. 2580 P. | D. 611

**€ 3.876,00** prezzo: esterno come foto; interno con dotazione standard  
*price: outside as per photo; inside as per standard equipment*

- ANTE SIMPLY - *SIMPLY DOORS* - laccato opaco dark grey y18232 - *matt lacquered dark grey y18232*
- FIANCHI - *SIDES* - laccato opaco dark grey y18232 - *matt lacquered dark grey y18232*
- STRUTTURA INTERNA - *INTERNAL STRUCTURE* - laccato opaco dark grey y18232 - *matt lacquered dark grey y18232*
- MANIGLIA RETTA - *RETTA HANDLE* - laccato opaco dark grey y18232 - *matt lacquered dark grey y18232*

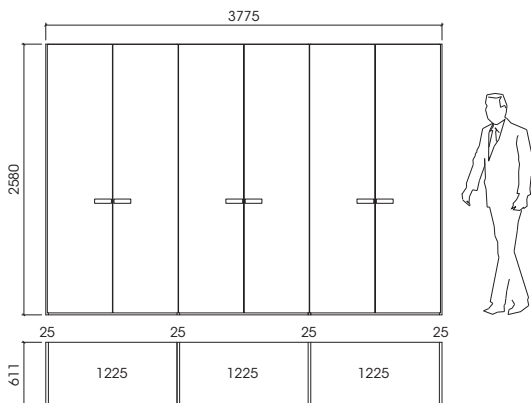



# BATTENTE | REGULAR DOOR

## composizioni fotografiche | photo compositions

**DOTAZIONE INTERNA VANO STANDARD: N. 1 ripiano, N. 2 tubi appendiabiti** | **STANDARD INTERNAL EQUIPMENT: 1 shelf, 2 clothes hangers**

### COMPOSIZIONE | COMPOSITION 13

L. 3546 H. 2356 P. | D. 611

**€ 3.127,00** prezzo: esterno come foto; interno con dotazione standard  
*price: outside as per photo; inside as per standard equipment*

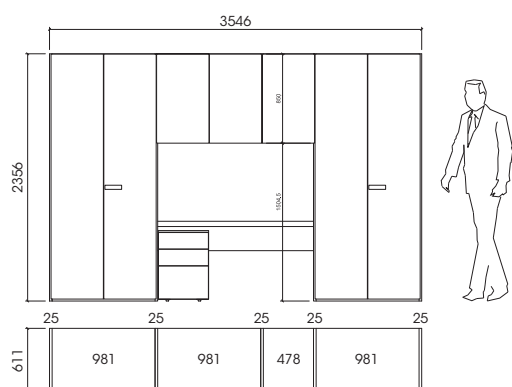

- ANTE SIMPLY  
- SIMPLY DOORS
- FIANCHI  
- SIDES
- STRUTTURA INTERNA  
- INTERNAL STRUCTURE
- MANIGLIA RETTA  
- RETTA HANDLE
- PIANO SCRIVANIA L. 1484  
- DESK TOP W. 1484
- CASSETTIERA  
- DRAWER UNIT
- laccato opaco bianco 9003  
- matt lacquered white 9003
- laccato opaco bianco 9003  
- matt lacquered white 9003
- melaminico  
- melamine
- laccato opaco bianco 9003  
- matt lacquered white 9003
- laccato opaco dark grey y18232  
- matt lacquered dark grey y18232
- laccato opaco dark grey y18232  
- matt lacquered dark grey y18232

### COMPOSIZIONE | COMPOSITION 14

L. 3775 H. 2580 P. | D. 611

**€ 5.236,00** prezzo: esterno come foto; interno con dotazione standard  
*price: outside as per photo; inside as per standard equipment*

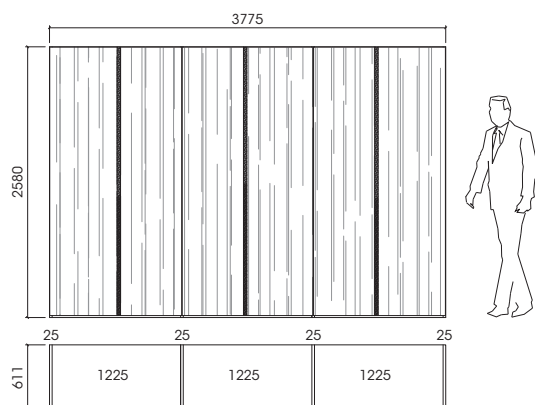

- ANTE CUBO BORDO 45°  
- DOORS CUBO W/45° EDGE CUT
- FIANCHI BORDO 45°  
- SIDES W/45° EDGE CUT
- STRUTTURA INTERNA  
- INTERNAL STRUCTURE
- MANIGLIA CUBO  
- CUBO HANDLE
- rovere termotrattato  
- heat-treated oak
- rovere termotrattato  
- heat-treated oak
- melaminico  
- melamine
- laccato opaco rosso 3003  
- matt lacquered red 3003

### COMPOSIZIONE | COMPOSITION 15

L. 3043 H. 2580 P. | D. 611

**€ 2.957,00** prezzo: esterno come foto; interno con dotazione standard  
*price: outside as per photo; inside as per standard equipment*

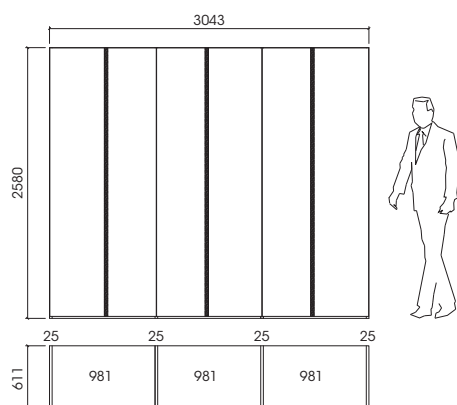

- ANTE CUBO BORDO 45°  
- DOORS CUBO W/45° EDGE CUT
- FIANCHI BORDO 45°  
- SIDES W/45° EDGE CUT
- STRUTTURA INTERNA  
- INTERNAL STRUCTURE
- MANIGLIA CUBO  
- CUBO HANDLE
- laccato opaco grigio seta 7044  
- matt lacquered silk grey 7044
- laccato opaco grigio seta 7044  
- matt lacquered silk grey 7044
- melaminico  
- melamine
- laccato opaco biscotto 2010  
- matt lacquered biscuit 2010

# BATTENTE | *REGULAR DOOR*

## composizioni fotografiche | *photo compositions*

DOTAZIONE INTERNA VANO STANDARD: N. 1 ripiano, N. 2 tubi appendiabiti | *STANDARD INTERNAL EQUIPMENT: 1 shelf, 2 clothes hangers*

### COMPOSIZIONE | *COMPOSITION 16*

L. 4049 H. 2580 P. | D. 611

**€ 4.418,00** prezzo: esterno come foto; interno con dotazione standard  
*price: outside as per photo; inside as per standard equipment*

- ANTE GLASS VETRO  
- *GLASS VETRO DOORS*

- telaio brunito - vetro trasparente grigio  
- *burnished frame - transparent grey glass*

- FIANCHI  
- *SIDES*

- laccato opaco dark grey y18232  
- *matt lacquered dark grey y18232*

- STRUTTURA INTERNA  
- *INTERNAL STRUCTURE*

- melaminico  
- *melamine*

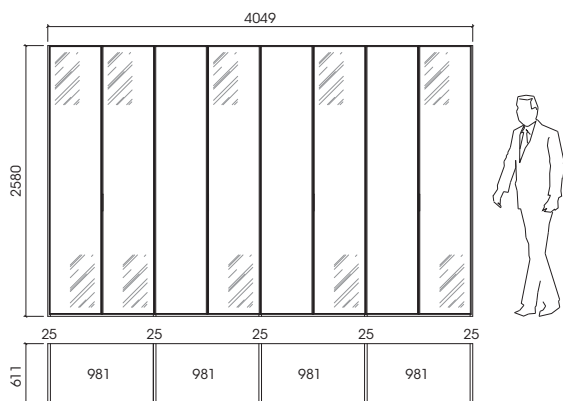





SCORREVOLE  
SLIDING DOOR



# SCORREVOLE | SLIDING DOOR

caratteristiche dimensionali | *dimensional characteristics*

## MODULARITÀ ORIZZONTALE | *HORIZONTAL MODULES*

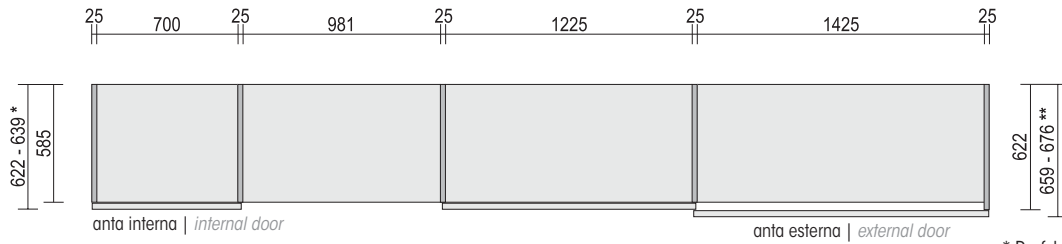

## MODULARITÀ VERTICALE | *VERTICAL MODULES*

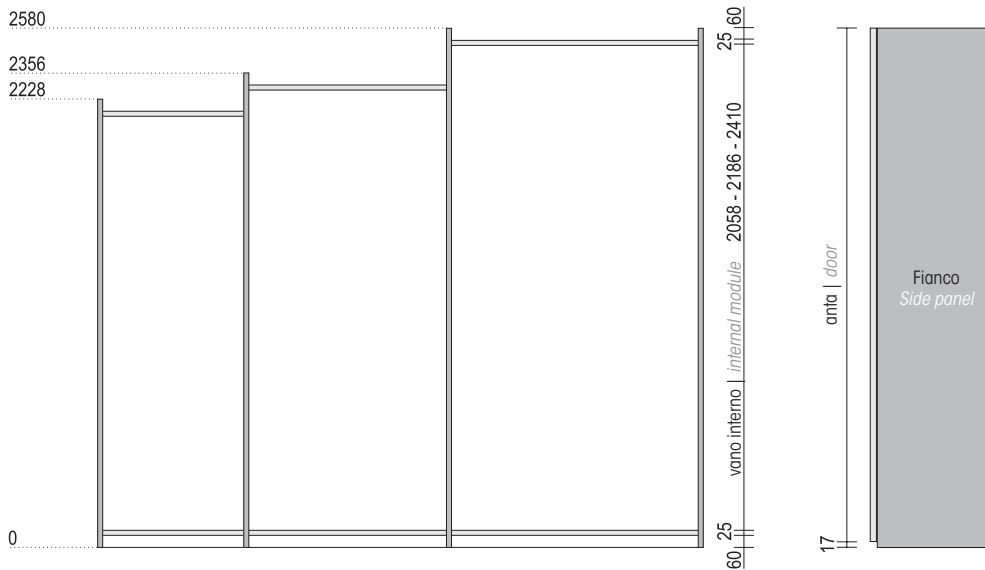





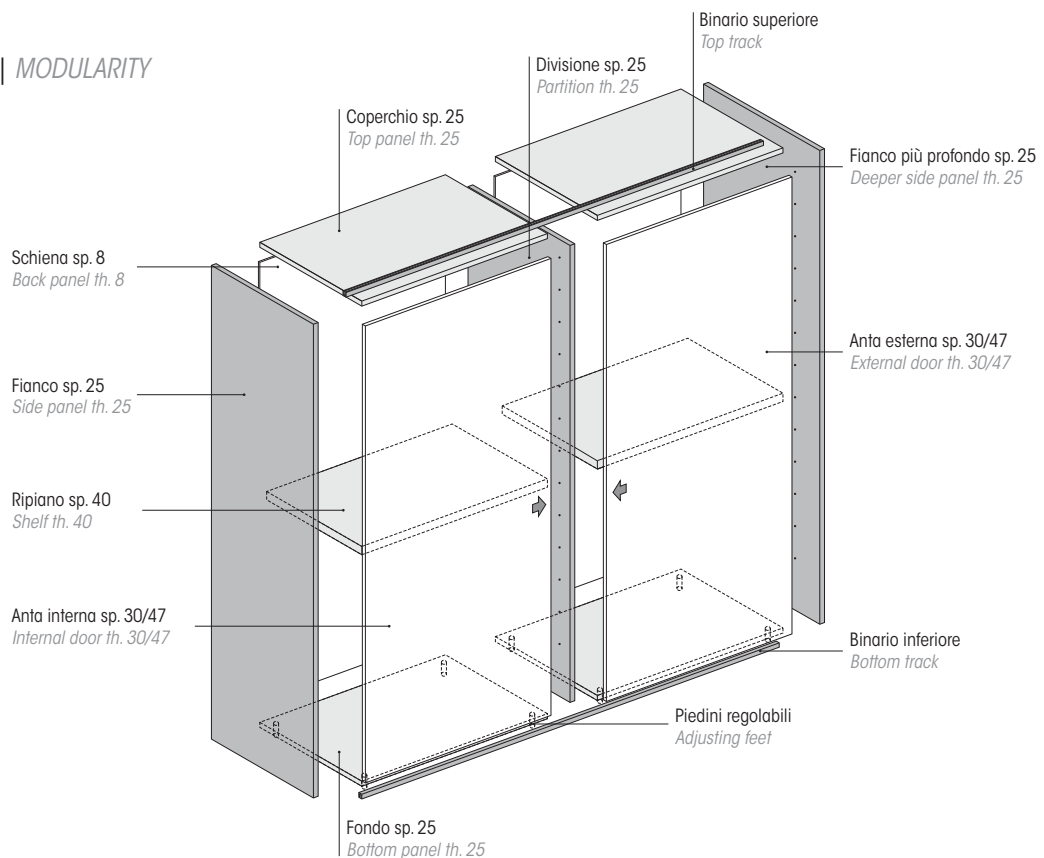



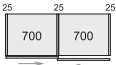
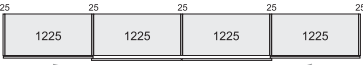

- \* Prof. lato c/anta interna:  
622 con anta sp. 30  
639 c/anta telaio sp. 47
- \* Depth side w/internal door:  
622 with door th. 30  
639 w/frame door th. 47
- \*\* Prof. totale armadio:  
659 con anta sp. 30  
676 c/anta telaio sp. 47
- \*\* Wardrobe total depth:  
659 with door th. 30  
676 w/frame door th. 47

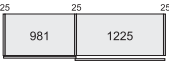
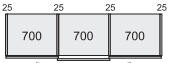
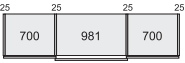
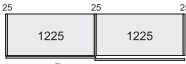
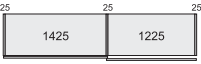
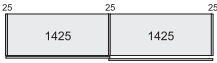
## COMPONIBILITÀ | *MODULARITY*

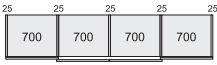
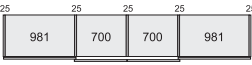
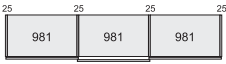
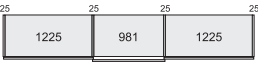

# SCORREVOLE | SLIDING DOOR

componibilità orizzontale | horizontal modularity

larghezza length		larghezza length	
1475		5025	
2037		2281	
2200		2481	
2525		2725	
2925		3287	
2925		3487	
3043		3531	
3775		4175	
4049		4537	
4375			<p><b>* vano non attrezzabile con cassettiere o elementi estraibili</b></p> <p><i>* no internal drawers nor removable elements can be placed inside</i></p>

### ATTENZIONE:

I binari di scorrimento delle ante sono predisposti per il collegamento di un minimo di 2 e di un massimo di 3 vani, qualsiasi sia la loro dimensione. Per composizioni con più di 3 vani si utilizzano più binari.

I binari di scorrimento vengono consegnati in un collo a parte e in dimensione intera. La lunghezza è pari alla larghezza totale dell'armadio al netto dei fianchi.

I binari per gli armadi a 2 ante alloggiano di regola 1 anta interna a sinistra e 1 anta esterna a destra, ma è possibile anche la configurazione opposta.

I binari per gli armadi a 3 ante alloggiano 1 anta interna a sinistra, 1 anta esterna centrale (con scorrimento di regola a destra, ma è possibile anche l'inverso) ed 1 anta interna a destra.

Gli armadi composti da più di 3 vani utilizzano più binari. In questo caso la 1° anta a sinistra del 2° binario è dello stesso tipo dell'ultima anta a destra del binario che la precede.

### ATTENTION:

The tracks on which the doors slide have been projected for minimum 2- maximum 3 units, whichever their size may be. For larger closets more tracks are needed. The tracks are packed separately and delivered entire. Their length corresponds to the wardrobe length minus the side panels.

The 2-door wardrobe tracks fit for 1 left internal door and 1 right external door, but also the opposite configuration is possible.

The 3-door wardrobe tracks fit for 1 left internal door, 1 middle external door (sliding rightward, but also the contrary is possible) and 1 right internal door.

The wardrobe with more than 3 units need more tracks. The first left door of the second track shall be of the same kind of the last right door of the preceding track.

**SCORREVOLE | SLIDING DOOR**  
 utilizzo fianchi | employ of side panels

**FIANCO | SIDE PANEL**



Pianta - Plan

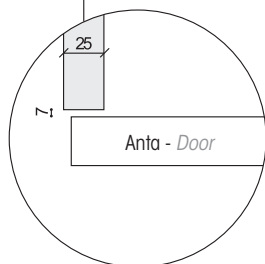
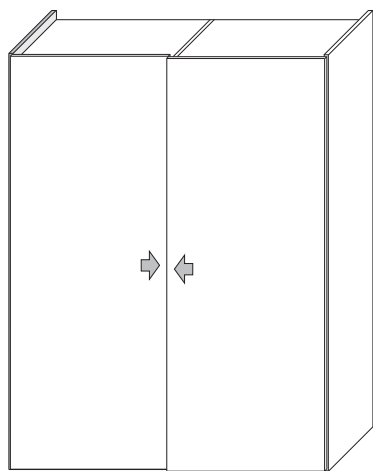

**FIANCO | SIDE PANEL**  
 P. | D. 585  
 Sp. | Th. 25  
 H. 2228 - 2356 - 2580

**FIANCO PIÙ PROFONDO | DEEPER SIDE PANEL**



Pianta - Plan

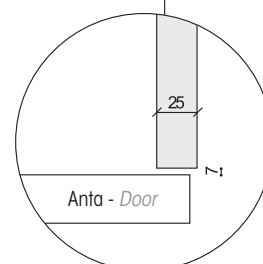
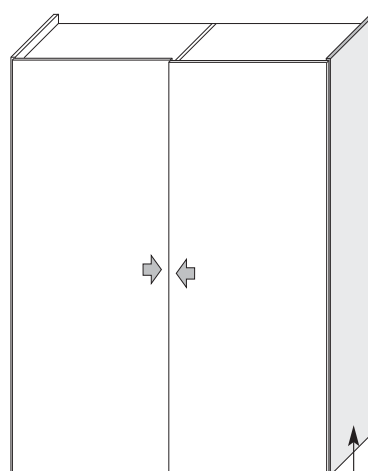

**FIANCO PIÙ PROFONDO | DEEPER SIDE PANEL**  
 P. | D. 622  
 Sp. | Th. 25  
 H. 2228 - 2356 - 2580

# SCORREVOLE | SLIDING DOOR

utilizzo divisioni | employ of partitions

## DIVISIONI | PARTITIONS

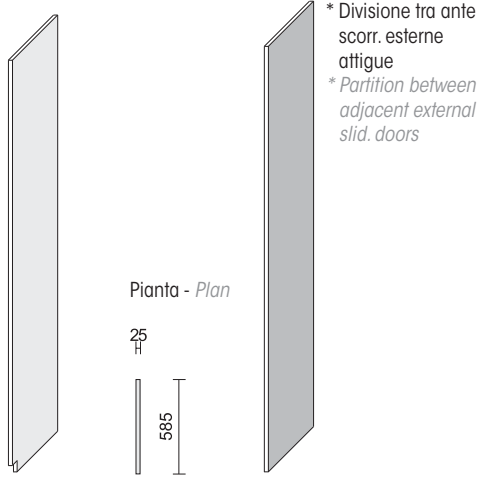

\* Divisione tra ante scorr. esterne attigue  
\* Partition between adjacent external slid. doors

Ante scorr. esterne attigue | Adjacent external slid. doors

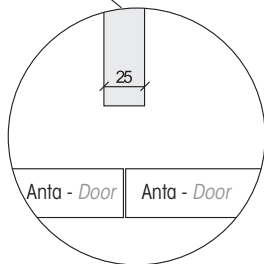
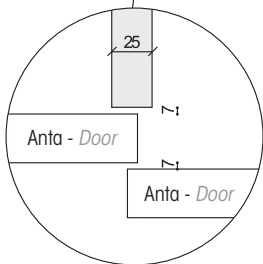
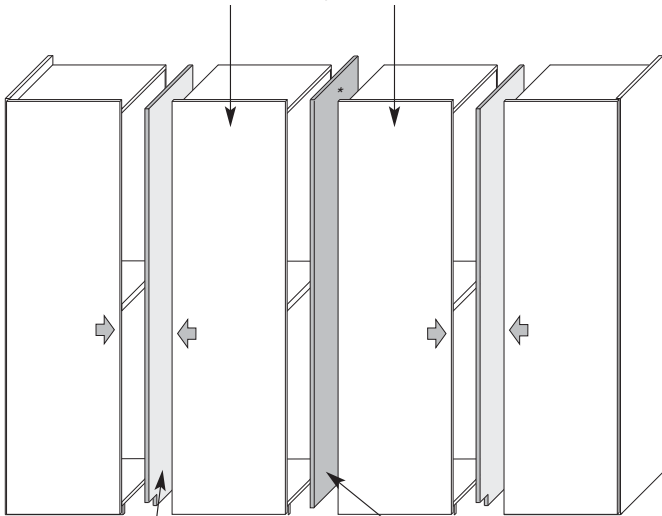

**DIVISIONE | PARTITION**  
P. | D. 585  
Sp. | Th. 25  
H. 2168 - 2296 - 2520

**DIVISIONE TRA ANTE SCORR. ESTERNE ATTIGUE**  
**PARTITION BETWEEN ADJAC. EXTERNAL SLID. DOORS**  
P. | D. 585  
Sp. | Th. 25

## DIVISIONE SPECIALE | SPECIAL PARTITION

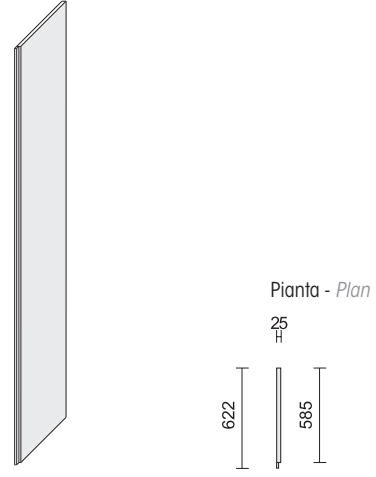

Divisione standard ar. battente  
Standard partition for regular wardrobe

Divisione speciale  
Special partition

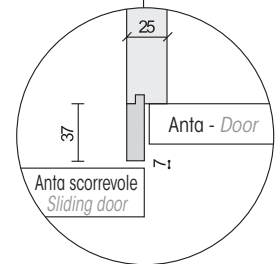
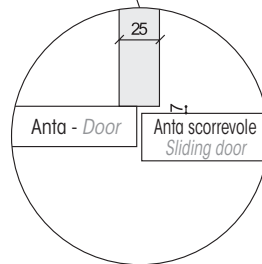
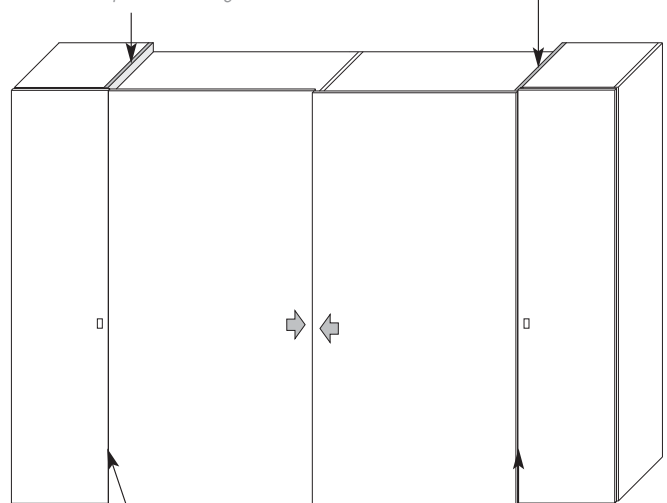

**DIVISIONE SPECIALE tra battente e scorrevole**  
**SPECIAL PARTITION between regular and sliding door**  
P. | D. 622  
Sp. | Th. 25  
H. 2228 - 2356 - 2580

# SCORREVOLE | SLIDING DOOR

caratteristiche fianchi e divisioni | characteristics of side panels and partitions

## FIANCHI | SIDE PANELS

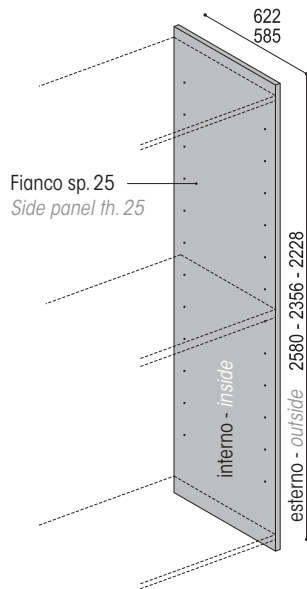

### FINITURE | FINISHES

#### Interno | Inside

- melaminico magnolia | *magnolia melamine*
- melaminico decorativo tessuto | *decorative material melamine*
- melaminico rovere termotrattato | *heat-treated oak melamine*
- laccato opaco | *mat lacquer* \*\*

#### Esterno | Outside

- laccato opaco e lucido | *mat and glossy lacquer* \*\*
- rovere moro (venatura orizz.) | *oak in mahogany finish (horiz. grain)*
- rovere tabacco (venatura orizz.) | *oak in tobacco finish (horiz. grain)*
- rovere lacc. poro aperto (venatura orizz.) | *lacq. oak open pore (horiz. grain)*
- rovere nodi (venatura vert.) | *oak knots (vertical grain)*
- rovere termotrattato (venatura vert.) | *heat-treated oak (vertical grain)*

### CARATTERISTICHE TECNICHE | TECHNICAL CHARACTERISTICS

Pannello di particelle di legno di classe E1 sp. 25 mm impiallacciato rovere nella finitura moro - tabacco - lacc. poro aperto - rovere nodi - rovere termotrattato; nobilitato con carta melaminica per i laccati opachi o lucidi.  
25 mm thick E1 wood particle panels veneered with oak in mahogany-tobacco finish - lacq. open pore oak - oak knots - heat-treated oak; laminated with melamine paper for matt or glossy lacquers.

**N.B.:** Nel lato interno è presente una foratura diametro 3 mm a passo 160, per il posizionamento degli eventuali ripiani.  
*Note: Internally, on the side, there is a drilling of diameter 3 mm, step 160, for the placement of shelves.*

## DIVISIONI | PARTITIONS

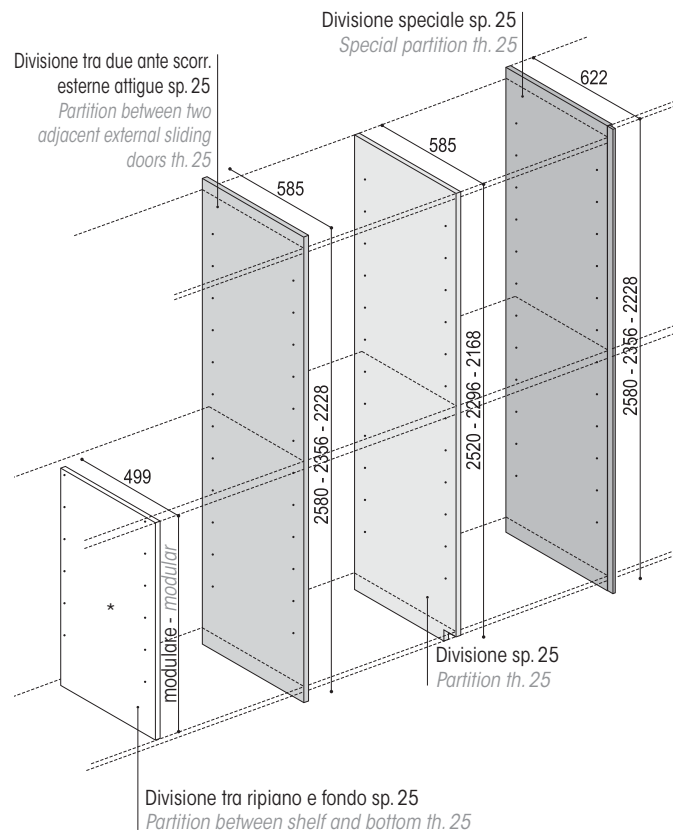

### FINITURE | FINISHES

- melaminico magnolia | *magnolia melamine*
- melaminico decorativo tessuto | *decorative material melamine*
- melaminico rovere termotrattato | *heat-treated oak melamine*
- laccato opaco | *mat lacquer* \*\*

### CARATTERISTICHE TECNICHE | TECHNICAL CHARACTERISTICS

Pannello di particelle di legno di classe E1 sp. 25 mm nobilitato con carta melaminica finitura magnolia, decorativo tessuto e rovere termotrattato; disponibile anche laccato opaco.  
25 mm thick E1 wood particle panels with melamine paper, magnolia finish, decorative material and heat-treated oak; also available matt lacquered.

**N.B.:** Nelle divisioni è presente una foratura diametro 3 mm a passo 160, per il posizionamento degli eventuali ripiani. La divisione tra ripiano e fondo viene tagliata in base all'utilizzo a passo 160 mm.

*Note: Partitions include a drilling of diameter 3 mm, step 160, for the placement of shelves. The partition between shelf and bottom is cut depending on use with step 160 mm.*

\*\* disponibile in tutta la gamma colori - available in all the colour range



# SCORREVOLE | SLIDING DOOR

maniglie | handles

ALFA	BETA	EPSILON	VIP	LAMA H. 40	LAMA H. 330
<b>FINITURE - FINISHES</b>					
Nichel satinato <i>Satin nickel</i>	Nichel satinato <i>Satin nickel</i>	Cromo <i>Chrome</i>	Brunito - <i>Burnished</i> Bianco - <i>White</i> Lacc. opaco ** <i>Matt lacquer **</i>	Laccato opaco bianco e colori cartella ** <i>White matt lacquered or</i> <i>colour as per samples card **</i>	Laccato opaco bianco e colori cartella ** <i>White matt lacquered or</i> <i>colour as per samples card **</i>
<b>LUNGHEZZA E POSIZIONAMENTO - LENGHT AND POSITIONING</b>					
<b>L. 960</b> 	<b>L. 655 - 335</b> 	<b>L. 67</b> ad incasso laterale - <i>built-in on the side</i> 	<b>L. 395</b> ad incasso - <i>built-in</i> 	<b>L. 40</b> 	<b>L. 330</b> 
<b>UTILIZZABILE NELL'ANTA - TO BE USED WITH DOOR</b>					
SLIDE INCISA - ONDA	SLIDE INCISA - ONDA	SLIDE INCISA - ONDA COMPOSTA VERTICAL	SLIDE INCISA - ONDA COMPOSTA	VERTICAL RIGA SLIDE - INCISA ONDA	VERTICAL SLIDE - INCISA ONDA
<b>CODICE E PREZZO - CODE AND PRICE</b>					
<b>43</b>	L. 655 <b>34</b>  L. 335 <b>25</b>	<b>22</b>	Brunito-bianco <i>Burnish-white</i> <b>36</b>  Lacc. opaco <i>Matt lacquer</i> <b>48</b>	Bianco <i>White</i> <b>35</b>  Lacc. opaco <i>Matt lacquer</i> <b>35</b>	Bianco <i>White</i> <b>43</b>  Lacc. opaco <i>Matt lacquer</i> <b>43</b>

\*\* disponibile in tutta la gamma colori - available in all the colour range

# SCORREVOLE | SLIDING DOOR

tipologia di ante | door type

## SLIDE anta scorrevole | sliding door

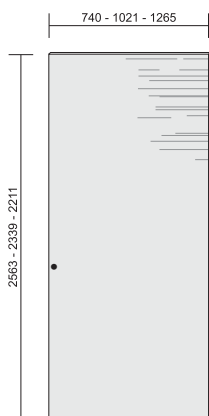

sezione - section

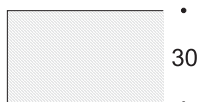

### FINITURE | FINISHES

- laccato opaco e lucido | *mat and glossy lacquer* \*\*
- rovere lacc. poro aperto (venatura orizz.) | *lacq. oak. open pore (horizontal grain.)* \*\*
- rovere nodi (venatura orizz.) | *oak knots (horizontal grain.)*
- rovere termotrattato (venatura orizz.) | *heat-treated oak (horizontal grain.)*

### CARATTERISTICHE TECNICHE | TECHNICAL CHARACTERISTICS

Pannello tamburato sp. 30 con copertine in particelle di legno ad alta densità di classe E1 sp. 4 mm, impiallacciato rovere per il lacc. poro aperto, rovere nodi, rovere termotrattato, laccato opaco o lucido.

*Honeycomb panel th. 30 with covers made of high density E1 class th. 4 mm wood particles, in oak veneer for the open pore lacq., oak knots, heat-treated oak, mat or glossy lacquer.*

### MANIGLIE UTILIZZABILI | HANDLES

- Alfa - Beta - Epsilon - Vip
- Lama H. 40 - Lama H. 330

### MODULARITÀ PREVISTA | PROVIDED MODULARITY



## INCISA - ONDA anta scorrevole | sliding door

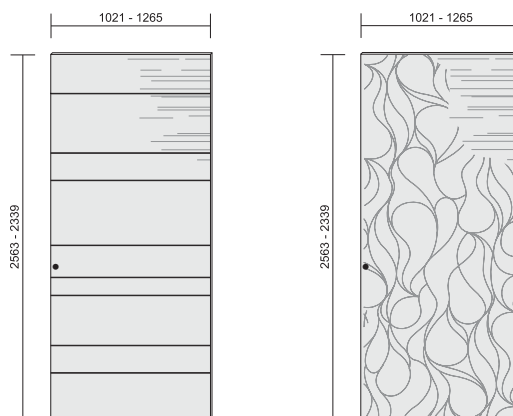

sezione - section

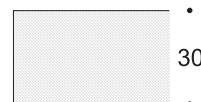

### FINITURE | FINISHES

- rovere lacc. poro aperto con incisioni (venatura orizz.) \*\*
- lacq. oak open pore with engravings (horiz. grain) \*\*

### CARATTERISTICHE TECNICHE | TECHNICAL CHARACTERISTICS

Pannello tamburato sp. 30 con copertine in particelle di legno ad alta densità di classe E1 sp. 4 mm, impiallacciato rovere lacc. poro aperto con incisioni.  
*Honeycomb panel th. 30 with covers made of high density E1 class th. 4 mm wood particles, in oak veneer for the open pore lacq. with engravings.*

### MANIGLIE UTILIZZABILI | HANDLES

- Alfa - Beta - Epsilon - Vip
- Lama H. 40 - Lama H. 330

### MODULARITÀ PREVISTA | PROVIDED MODULARITY



\*\* disponibile in tutta la gamma colori - available in all the colour range

# SCORREVOLE | SLIDING DOOR

tipologia di ante | door type

## TECNO anta scorrevole | sliding door

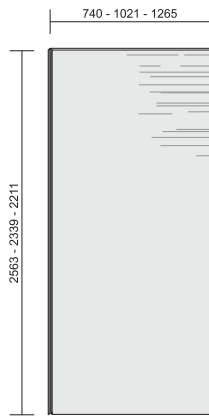

sezione - section

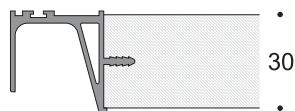

### FINITURE | FINISHES

- laccato opaco e lucido | *mat and glossy lacquer* \*\*
- rovere lacc. poro aperto (venatura orizz.) | *lacq. oak. open pore (horizontal grain.)* \*\*
- rovere nodi (venatura orizz.) | *oak knots (horizontal grain.)*
- rovere termotrattato (venatura orizz.) | *heat-treated oak (horizontal grain.)*

### CARATTERISTICHE TECNICHE | TECHNICAL CHARACTERISTICS

Pannello tamburato sp. 30 con copertine in particelle di legno ad alta densità di classe E1 sp. 4 mm, impiallacciato rovere per il lacc. poro aperto, rovere nodi, rovere termotrattato, laccato opaco o lucido.

*Honeycomb panel th. 30 with covers made of high density E1 class th. 4 mm wood particles, in oak veneer for the open pore lacq., oak knots, heat-treated oak, matt or glossy lacquer.*

**MANIGLIA:** inserita per tutta la lunghezza dell'anta, disponibile in finitura bianco, brill spazzolato e laccato opaco colore \*\*

*HANDLE: built-in along the length of the door, finish available in white, brushed brill, and colour matt lacquer \*\**

### MODULARITÀ PREVISTA | PROVIDED MODULARITY



## COMPOSTA anta scorr./complanare | sliding/flush-fitting door

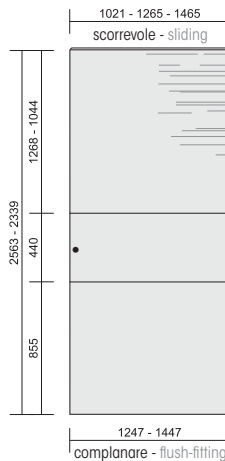

sezione - section

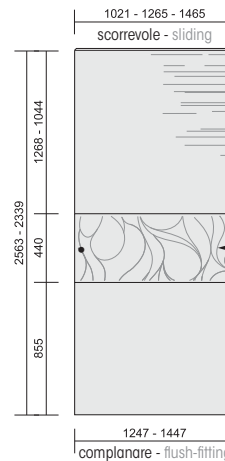

Possibilità di gestire e comporre ognuno dei 3 pannelli con una finitura diversa in base ai propri gusti. **Il pannello centrale inoltre è disponibile anche inciso.**

*Possibility to manage and compose each one of the 3 panels with a different finish according to personal taste.*

**The middle panel is also available in the engraved version.**

### FINITURE | FINISHES

- laccato opaco e lucido | *mat and glossy lacquer* \*\*
- rovere moro (venatura orizz.) | *oak in mahogany finish (horiz. grain)*
- rovere tabacco (venatura orizz.) | *oak in tobacco finish (horiz. grain)*
- rovere lacc. poro aperto (venatura orizz.) | *lacq. oak open pore (horiz. grain.)* \*\*
- rovere nodi (venatura orizz.) | *oak knots (horizontal grain.)*
- rovere termotrattato (venatura orizz.) | *heat-treated oak (horizontal grain.)*

### CARATTERISTICHE TECNICHE | TECHNICAL CHARACTERISTICS

Pannello tamburato sp. 30 con copertine in particelle di legno ad alta densità di classe E1 sp. 4 mm, impiallacciato rovere nella finitura moro - tabacco - lacc. poro aperto, rovere nodi, rovere termotrattato; laccato opaco o lucido.

*Honeycomb panel th. 30 with covers made of high density E1 class th. 4 mm wood particle panels veneered with oak in mahogany-tobacco finish, lacq. open pore oak, oak knots, heat-treated oak, matt or glossy lacquer.*

### MANIGLIE UTILIZZABILI | HANDLES

- Epsilon (solo per anta scorrevole | *only for sliding door*)
- Vip

### MODULARITÀ PREVISTA | PROVIDED MODULARITY



Solo per anta scorrevole - *Only for sliding door*

\*\* disponibile in tutta la gamma colori - *available in all the colour range*

# SCORREVOLE | SLIDING DOOR

tipologia di ante | door type

## COMPOSTA PLUS anta scorrevole | sliding door

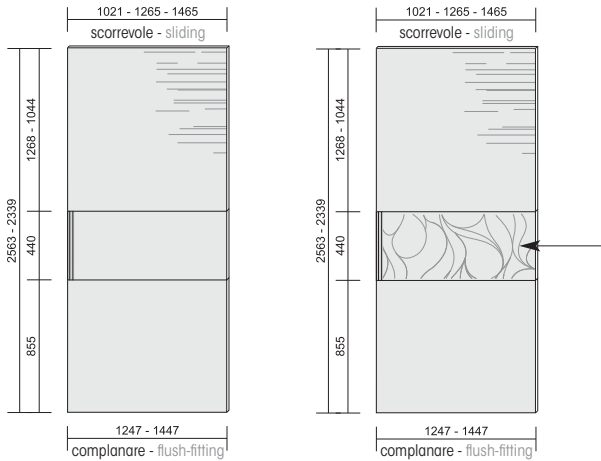

sezione - section

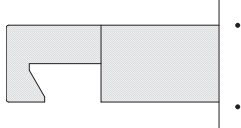

Possibilità di gestire e comporre ognuno dei 3 pannelli con una finitura diversa in base ai propri gusti. **Il pannello centrale inoltre è disponibile anche inciso.**  
*Possibility to manage and compose each one of the 3 panels with a different finish according to personal taste. The middle panel is also available in the engraved version.*

### FINITURE | FINISHES

- laccato opaco e lucido | *matt and glossy lacquer* \*\*
- rovere moro (venatura orizz.) | *oak in mahogany finish (horiz. grain)*
- rovere tabacco (venatura orizz.) | *oak in tobacco finish (horiz. grain)*
- rovere lacc. poro aperto (venatura orizz.) | *lacq. oak. open pore (horizontal grain.)* \*\*
- rovere nodi (venatura orizz.) | *oak knots (horizontal grain.)*
- rovere termotrattato (venatura orizz.) | *heat-treated oak (horizontal grain.)*

### CARATTERISTICHE TECNICHE | TECHNICAL CHARACTERISTICS

Pannello tamburato sp. 30 con copertine in particelle di legno ad alta densità di classe E1 sp. 4 mm, impiallacciato rovere per il lacc. poro aperto, rovere moro, rovere tabacco, rovere nodi, rovere termotrattato, laccato opaco o lucido.  
*Honeycomb panel th. 30 with covers made of high density E1 class th. 4 mm wood particles, in oak veneer for the open pore lacq., oak in mahogany finish, oak in tobacco, finish, oak knots, heat-treated oak, matt or glossy lacquer.*

**MANIGLIA:** inserita su pannello H. 440. Disponibile in finitura opaco, rovere nodi, rovere termotrattato, rovere laccato poro aperto, rovere moro, rovere tabacco, lucido.

*HANDLE: built-in along the panel H. 440. Available in matt lacquer, oak knots, heat-treated oak, open pore lacq. oak, oak in mahogany finish, oak in tobacco finish, glossy lacquer*

### MODULARITÀ PREVISTA | PROVIDED MODULARITY



Solo per anta scorrevole - Only for sliding door

## GREEN anta scorrevole/complanare | sliding/flush-fitting door

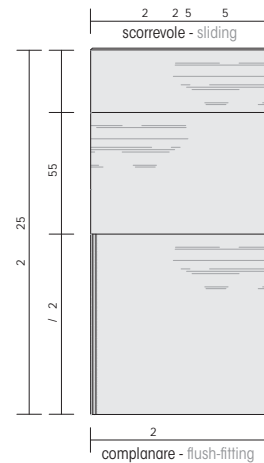

sezione - section

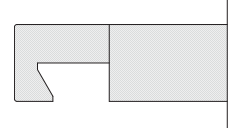

### FINITURE PANNELLO | PANEL FINISHES

- laccato opaco e lucido | *matt and glossy lacquer* \*\*
- rovere nodi (venatura orizz.) | *oak knots (horizontal grain.)*
- rovere termotrattato (venatura orizz.) | *heat-treated oak (horizontal grain.)*
- rovere lacc. poro aperto (venatura orizz.) | *lacq. oak. open pore (horizontal grain.)* \*\*

### CARATTERISTICHE TECNICHE | TECHNICAL CHARACTERISTICS

Pannello tamburato sp. 30 con copertine in particelle di legno ad alta densità di classe E1 sp. 4 mm, impiallacciato rovere per il laccato poro aperto, rovere nodi e rovere termotrattato; laccato opaco o lucido.

*30 mm thick honeycomb panel coated with high density E1 class th. 4 mm wood particle sheet, in oak veneer for the open pore lacq. oak, oak knots or heat-treated oak; matt or glossy lacquer.*

**MANIGLIA:** inserita per tutta la lunghezza pannello inferiore H. 1044 - 1268, disponibile in finitura opaco, rovere nodi, rovere termotrattato, rovere laccato poro aperto, lucido.

*HANDLE: built-in along the length of the H. 1044-1268 lower panel, available in matt lacquer, oak knots, heat-treated oak, open pore lacq., glossy finish*

### MODULARITÀ PREVISTA | PROVIDED MODULARITY



Solo per anta scorrevole - Only for sliding door

\*\* disponibile in tutta la gamma colori - available in all the colour range

# SCORREVOLE | SLIDING DOOR

tipologia di ante | door type

## VERTICAL anta scorrevole | sliding door

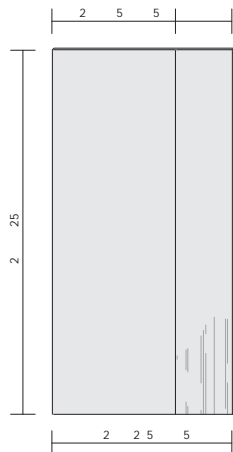

sezione - section

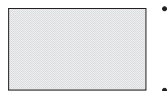

### FINITURE PANNELLO "A" | PANEL "A" FINISHES

- laccato opaco, laccato lucido | *Matt lacquered, glossy lacquered* \*\*

### CARATTERISTICHE TECNICHE | TECHNICAL CHARACTERISTICS

Pannello tamburato sp. 30 con copertine in particelle di legno ad alta densità di classe E1 sp. 4 mm, laccato opaco o lucido.

*Honeycomb panel th. 30 coated with high density E1 class th.4 mm wood particle sheet, in matt or glossy lacquer.*

### FINITURE PANNELLO "B" | PANEL "B" FINISHES

- laccato opaco, laccato lucido, rovere nodi, rovere termotrattato, rovere laccato poro aperto, rovere moro, rovere tabacco

- *matt lacquered, glossy lacquered, oak knots, heat treated oak, open pore lacq. oak, oak in mahogany finish, oak in tobacco finish* \*\*

### CARATTERISTICHE TECNICHE | TECHNICAL CHARACTERISTICS

Pannello in truciolare melaminico per laccato o truciolare grezzo impiallacciato per essenza, sp. 30 mm

*30mm thick wood particle board panel coated with melamine paper for lacquers, or chipboard panel with veneer for wood finishes.*

### MANIGLIE UTILIZZABILI | HANDLES AVAILABLE

- EPSILON
- LAMA H. 40
- LAMA H. 330

### MODULARITÀ PREVISTA | PROVIDED MODULARITY



## RIGA anta scorrevole | sliding door

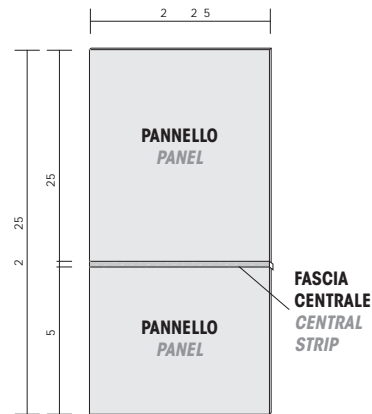

sezione - section

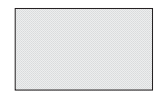

### FINITURE PANNELLO | PANEL FINISH

- laccato opaco, laccato lucido | *Matt lacquered, glossy lacquered* \*\*

### FINITURE FASCIA CENTRALE | CENTRAL STRIP FINISHES

- laccato opaco, laccato lucido, rovere nodi, rovere termotrattato, rovere laccato poro aperto, rovere moro, rovere tabacco

- *matt lacquered, glossy lacquered, oak knots, heat treated oak, open pore lacq. oak, oak in mahogany finish, oak in tobacco finish* \*\*

### CARATTERISTICHE TECNICHE | TECHNICAL CHARACTERISTICS

Pannello tamburato sp. 30 con copertine in particelle di legno ad alta densità di classe E1 sp. 4 mm., laccato opaco o lucido.

Fascia centrale in legno laccato opaco e lucido o finitura rovere nodi e rovere termotrattato, Sp.30mm.

*30 mm thick honeycomb panel coated with high density E1 class th. 4 mm wood particle sheet in matt or glossy lacquer. Central strip in matt or glossy lacquered wood or oak knots and heat-treated oak, th. 30 mm*

### MANIGLIE UTILIZZABILI | HANDLES AVAILABLE

- LAMA H. 40

### MODULARITÀ PREVISTA | PROVIDED MODULARITY



\*\* disponibile in tutta la gamma colori - available in all the colour range

# SCORREVOLE | SLIDING DOOR

tipologia di ante | door type

## TELAIO "O" anta scorrevole | sliding door

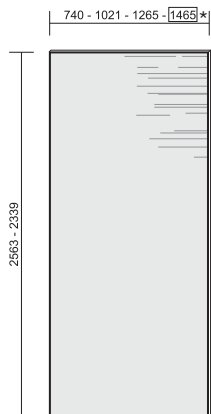

\* Questa larghezza è disponibile solo con vetro bianco o specchi.

\* This width is available only with white glass or mirrors.

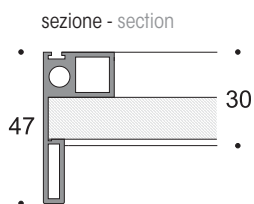

### FINITURE | FINISHES

- laccato opaco e lucido | *matt and glossy lacquer* \*\*
- rovere moro (venatura orizz.) | *oak in mahogany finish (horiz. grain)*
- rovere tabacco (venatura orizz.) | *oak in tobacco finish (horiz. grain)*
- rovere lacc. poro aperto (venatura orizz.) | *lacq. oak open pore (horiz. grain)* \*\*
- vetro o specchio | *glass or mirror* \*\*

### CARATTERISTICHE TECNICHE | TECHNICAL CHARACTERISTICS

Pannello di particelle di legno di classe E1 sp. 12 mm impiallacciato rovere nella finitura moro - tabacco - lacc. poro aperto; nobilitato con carta melaminica per i laccati opachi o lucidi. Vetro o specchio sp. 4 mm.

12 mm thick E1 wood particle panels veneered with oak in mahogany-tobacco finish - lacq. open pore; laminated with melamine paper for matt or glossy lacquers. 4 mm th. glass or mirror. 4 mm.

MANIGLIA: il telaio dell'anta permette la presa senza bisogno di maniglia, disponibile in alluminio finitura bianco, brill spazzolato o laccato opaco colore \*\*  
HANDLE: The door frame allows the opening without the need of a handle, available in white aluminium finish, brushed brill or matt lacquered color \*\*

### MODULARITÀ PREVISTA | PROVIDED MODULARITY



## TELAIO "A" anta scorrevole | sliding door

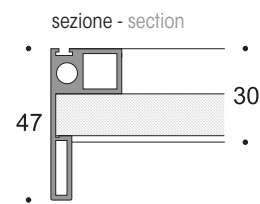
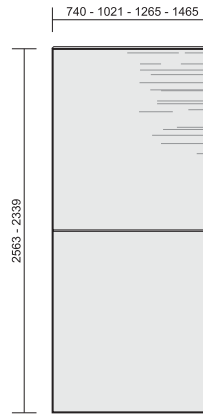

### FINITURE | FINISHES

- laccato opaco e lucido | *matt and glossy lacquer* \*\*
- rovere moro (venatura orizz.) | *oak in mahogany finish (horiz. grain)*
- rovere tabacco (venatura orizz.) | *oak in tobacco finish (horiz. grain)*
- rovere lacc. poro aperto (venatura orizz.) | *lacq. oak open pore (horiz. grain)* \*\*
- vetro o specchio | *glass or mirror* \*\*

### CARATTERISTICHE TECNICHE | TECHNICAL CHARACTERISTICS

Pannello di particelle di legno di classe E1 sp. 12 mm impiallacciato rovere nella finitura moro - tabacco - lacc. poro aperto; nobilitato con carta melaminica per i laccati opachi o lucidi. Vetro o specchio sp. 4 mm.

12 mm thick E1 wood particle panels veneered with oak in mahogany-tobacco finish - lacq. open pore; laminated with melamine paper for matt or glossy lacquers. 4 mm th. glass or mirror. 4 mm.

MANIGLIA: il telaio dell'anta permette la presa senza bisogno di maniglia, disponibile in alluminio finitura bianco, brill spazzolato o laccato opaco colore \*\*  
HANDLE: The door frame allows the opening without the need of a handle, available in white aluminium finish, brushed brill or matt lacquered color \*\*

### MODULARITÀ PREVISTA | PROVIDED MODULARITY



\*\* disponibile in tutta la gamma colori - available in all the colour range

# SCORREVOLE | SLIDING DOOR

tipologia di ante | door type

## TELAIO "C" anta scorrevole | sliding door

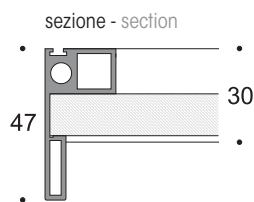

### FINITURE | FINISHES

- laccato opaco e lucido | *matt and glossy lacquer* \*\*
- rovere moro (venatura orizz.) | *oak in mahogany finish (horiz. grain)*
- rovere tabacco (venatura orizz.) | *oak in tobacco finish (horiz. grain)*
- rovere lacc. poro aperto (venatura orizz.) | *lacq. oak open pore (horiz. grain)* \*\*
- vetro o specchio | *glass or mirror* \*\*

### CARATTERISTICHE TECNICHE | TECHNICAL CHARACTERISTICS

Pannello di particelle di legno di classe E1 sp. 12 mm impiallacciato rovere nella finitura moro - tabacco - lacc. poro aperto; nobilitato con carta melaminica per i laccati opachi o lucidi. Vetro o specchio sp. 4 mm.

*12 mm thick E1 wood particle panels veneered with oak in mahogany-tobacco finish - lacq. open pore; laminated with melamine paper for matt or glossy lacquers. 4 mm th. glass or mirror. 4 mm.*

**MANIGLIA:** il telaio dell'anta permette la presa senza bisogno di maniglia, disponibile in alluminio finitura bianco, brill spazzolato o laccato opaco colore \*\*  
*HANDLE:* The door frame allows the opening without the need of a handle, available in white aluminium finish, brushed brill or matt lacquered color \*\*

### MODULARITÀ PREVISTA | PROVIDED MODULARITY



## TELAIO "D" anta scorrevole | sliding door

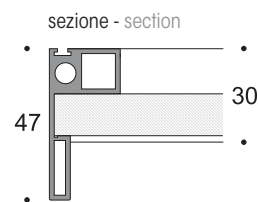
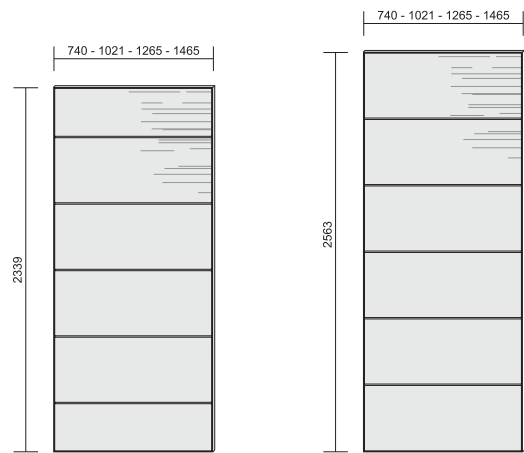

### FINITURE | FINISHES

- laccato opaco e lucido | *matt and glossy lacquer* \*\*
- rovere moro (venatura orizz.) | *oak in mahogany finish (horiz. grain)*
- rovere tabacco (venatura orizz.) | *oak in tobacco finish (horiz. grain)*
- rovere lacc. poro aperto (venatura orizz.) | *lacq. oak open pore (horiz. grain)* \*\*
- vetro o specchio | *glass or mirror* \*\*

### CARATTERISTICHE TECNICHE | TECHNICAL CHARACTERISTICS

Pannello di particelle di legno di classe E1 sp. 12 mm impiallacciato rovere nella finitura moro - tabacco - lacc. poro aperto; nobilitato con carta melaminica per i laccati opachi o lucidi. Vetro o specchio sp. 4 mm.

*12 mm thick E1 wood particle panels veneered with oak in mahogany-tobacco finish - lacq. open pore; laminated with melamine paper for matt or glossy lacquers. 4 mm th. glass or mirror. 4 mm.*

**MANIGLIA:** il telaio dell'anta permette la presa senza bisogno di maniglia, disponibile in alluminio finitura bianco, brill spazzolato o laccato opaco colore \*\*  
*HANDLE:* The door frame allows the opening without the need of a handle, available in white aluminium finish, brushed brill or matt lacquered color \*\*

### MODULARITÀ PREVISTA | PROVIDED MODULARITY



\*\* disponibile in tutta la gamma colori - available in all the colour range

# SCORREVOLE | SLIDING DOOR

## fianchi | side panels

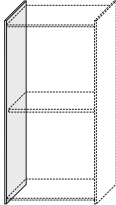
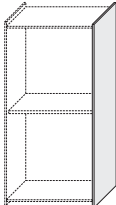
<p>- Prezzi di fianchi con finitura interna melaminico magnolia, decorativo tessuto e melaminico rovere termotrattato, per interno lacc. opaco applicare la maggiorazione.</p> <p>- Prices for side panels with magnolia, decorative material or heat-treated oak melamine inside finish, for inside with matt lacquer apply the increase.</p>	<p>CODICE</p> <p>CODE</p>	<p>lacc. opaco base</p> <p>basic matt lacq.</p>	<p>lacc. opaco colore</p> <p>colour matt lacq.</p>	<p>essenza</p> <p>wood</p>	<p>rovere lacc. poro aperto</p> <p>open pore lacq. oak</p>	<p>rovere termotrattato</p> <p>heat-treated oak</p>	<p>lacc. lucido</p> <p>glossy lacq.</p>		<p>Maggiorazione per interno laccato</p> <p>Increase for matt lacquered inside finish</p>
<p><b>FIANCO   SIDE PANEL</b></p> 	<p><b>P.   D. 585</b></p>								
<p><b>FIANCO PIÙ PROFONDO DEEPER SIDE PANEL</b></p> 	<p><b>P.   D. 622</b></p>								



# SCORREVOLE | SLIDING DOOR

divisioni | partitions

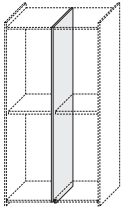
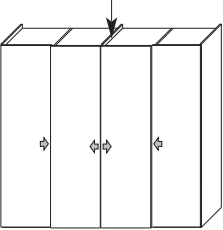
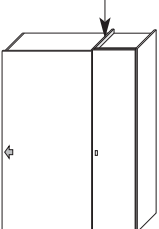
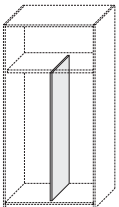
	CODICE	melaminico magnolia	melaminico decorativo tessuto	melaminico rovere termotrattato	lacc. opaco				
	CODE	magnolia melamine	decorative material melamine	heat-treated oak melamine	mat lacq.				
<b>DIVISIONE   PARTITION</b>									
	<b>P.   D. 585</b>								
	H. 2168	EMD15522	84	84	84	162			
	H. 2296	EMD15523	86	86	86	170			
	H. 2520	EMD15524	89	89	89	179			
<b>DIVISIONE</b> tra ante scorr. esterne attigue <b>PARTITION</b> between adjac. external slid. doors									
	<b>P.   D. 585</b>								
	H. 2228	EMD10522	81	81	81	158			
	H. 2356	EMD10523	84	84	84	165			
	H. 2580	EMD10524	88	88	88	178			
<b>DIVISIONE SPECIALE</b> tra battente e scorrevole <b>SPECIAL PARTITION</b> between regular and sliding door									
	<b>P.   D. 622</b>								
	H. 2228	EMD30622	190	190	190	268			
	H. 2356	EMD30623	193	193	193	274			
	H. 2580	EMD30624	198	198	198	287			
<b>DIVISIONE</b> tra ripiano e fondo, tagliata a misura modulare passo 160 <b>PARTITION</b> between shelf and bottom, cut to modular size with step 160									
	<b>P.   D. 499</b>								
		EMD40525	105	105	105	146			

# SCORREVOLE | SLIDING DOOR

slide

- Fianchi e divisioni a pag. | Side panels and partitions on page 96

- Prezzi calcolati con interno melaminico.

Dotazione interna vano standard: - N. 1 ripiano - N. 2 tubi appendiabiti







- Prices calculated with melamine inside finish.

Standard internal equipment: - 1 shelf - 2 clothes hangers

Maniglie a pag. | Handles on page 89







- Nell'anta TECNO la maniglia è inserita per tutta la lunghezza dell'anta: disponibile in finitura bianco, con maggiorazione di 35 euro per la finitura brill spazzolato e laccato opaco colore (da specificare nell'ordine).

- In the TECNO door, the handle is built-in along the length of the door: available in white finish, with increase of 35 euros for the brushed brill finish and colour matt lacquer (to be specified in the order).

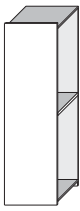
SLIDE lacc. opaco base basic matt lacq.	SLIDE lacc. opaco colore colour matt lacq.	SLIDE rovere lacc. poro aperto open pore lacq. oak	SLIDE lacc. lucido glossy lacq.	SLIDE rovere nodi oak knots	SLIDE rovere termotrattato heat-treated oak
					

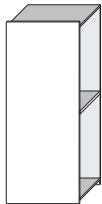
Sezione ante | Door section:

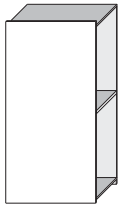











L. 700	H. H.	CODICE CODE	EL. 1 ANTA da 740 mm - escluso di fianchi e divisioni EL. 1 DOOR 740 mm - side panels and partitions not included						
 		2228 EMMS0245		<b>502</b>	<b>541</b>	<b>709</b>	<b>720</b>	<b>613</b>	<b>659</b>
		2356 EMMS0345		<b>512</b>	<b>551</b>	<b>728</b>	<b>740</b>	<b>627</b>	<b>674</b>
		2580 EMMS0445		<b>528</b>	<b>570</b>	<b>761</b>	<b>775</b>	<b>653</b>	<b>703</b>
L. 981	H. H.	CODICE CODE	EL. 1 ANTA da 1021 mm - escluso di fianchi e divisioni EL. 1 DOOR 1021 mm - side panels and partitions not included						
 		2228 EMMS0255		<b>651</b>	<b>703</b>	<b>893</b>	<b>949</b>	<b>768</b>	<b>826</b>
		2356 EMMS0355		<b>659</b>	<b>714</b>	<b>914</b>	<b>972</b>	<b>781</b>	<b>840</b>
		2580 EMMS0455		<b>690</b>	<b>750</b>	<b>963</b>	<b>1.030</b>	<b>819</b>	<b>885</b>
L. 1225	H. H.	CODICE CODE	EL. 1 ANTA da 1265 mm - escluso di fianchi e divisioni EL. 1 DOOR 1265 mm - side panels and partitions not included						
 		2228 EMMS0265		<b>807</b>	<b>868</b>	<b>1.102</b>	<b>1.163</b>	<b>948</b>	<b>1.012</b>
		2356 EMMS0365		<b>819</b>	<b>885</b>	<b>1.131</b>	<b>1.194</b>	<b>963</b>	<b>1.031</b>
		2580 EMMS0465		<b>857</b>	<b>928</b>	<b>1.193</b>	<b>1.265</b>	<b>1.008</b>	<b>1.087</b>

Ulteriori combinazioni di aperture e finiture sono possibili utilizzando le scocche vuote a pag. | Additional finishes and opening combinations are possible using the empty bodies on page 168

# SCORREVOLE | SLIDING DOOR

incisa, onda, tecno

INCISA rovere lacc. poro aperto <i>open pore lacq. oak</i>	ONDA rovere lacc. poro aperto <i>open pore lacq. oak</i>	TECNO lacc. opaco base <i>basic matt lacq.</i>	TECNO lacc. opaco colore <i>colour matt lacq.</i>	TECNO rovere lacc. poro aperto <i>open pore lacq. oak</i>	TECNO lacc. lucido <i>glossy lacq.</i>	TECNO rovere nodi <i>oak knots</i>	TECNO rovere termotrattato <i>heat-treated oak</i>		Maggiorazione per interno laccato opaco  <i>Increase for matt lacquered inside finish</i>
									
									
EL. 1 ANTA da 740 mm - escluso di fianchi e divisioni <i>EL. 1 DOOR 740 mm - side panels and partitions not included</i>									
		<b>545</b>	<b>586</b>	<b>750</b>	<b>769</b>	<b>662</b>	<b>706</b>		<b>93</b>
		<b>552</b>	<b>595</b>	<b>768</b>	<b>787</b>	<b>674</b>	<b>721</b>		<b>96</b>
		<b>571</b>	<b>616</b>	<b>802</b>	<b>824</b>	<b>703</b>	<b>755</b>		<b>101</b>
EL. 1 ANTA da 1021 mm - escluso di fianchi e divisioni <i>EL. 1 DOOR 1021 mm - side panels and partitions not included</i>									
		<b>684</b>	<b>735</b>	<b>941</b>	<b>997</b>	<b>813</b>	<b>871</b>		<b>132</b>
<b>975</b>	<b>1.027</b>	<b>692</b>	<b>746</b>	<b>962</b>	<b>1.019</b>	<b>826</b>	<b>885</b>		<b>136</b>
<b>1.026</b>	<b>1.077</b>	<b>724</b>	<b>782</b>	<b>1.001</b>	<b>1.062</b>	<b>871</b>	<b>932</b>		<b>142</b>
EL. 1 ANTA da 1265 mm - escluso di fianchi e divisioni <i>EL. 1 DOOR 1265 mm - side panels and partitions not included</i>									
		<b>845</b>	<b>906</b>	<b>1.136</b>	<b>1.200</b>	<b>992</b>	<b>1.055</b>		<b>164</b>
<b>1.196</b>	<b>1.248</b>	<b>858</b>	<b>922</b>	<b>1.165</b>	<b>1.228</b>	<b>1.004</b>	<b>1.074</b>		<b>170</b>
<b>1.261</b>	<b>1.312</b>	<b>898</b>	<b>967</b>	<b>1.232</b>	<b>1.300</b>	<b>1.069</b>	<b>1.137</b>		<b>176</b>

Ulteriori combinazioni di aperture e finiture sono possibili utilizzando le scocche vuote a pag. | *Additional finishes and opening combinations are possible using the empty bodies on page 168*

# SCORREVOLE | SLIDING DOOR

## slide

- **Attenzione:** la finitura dei fianchi segue la finitura dell'anta (ES: anta rovere lacc. poro aperto - fianco rovere lacc. poro aperto / anta lacc. opaco base - fianco lacc. opaco base).  
 - **Attention:** the finish of the sides follows the finish of the door (EX: open pore lacq. oak door - open pore lacq. oak side / basic matt lacq. door - basic matt lacq. side).

- **Prezzi calcolati con interno melaminico.**

**Dotazione interna vano standard:** - N. 1 ripiano - N. 2 tubi appendiabiti

- *Prices calculated with melamine inside finish.*

*Standard internal equipment:* - 1 shelf - 2 clothes hangers

- **Maniglie a pag. | Handles on page 89**

- **Nell'anta TECNO la maniglia è inserita per tutta la lunghezza dell'anta:** disponibile in finitura bianco, con maggiorazione di **35 euro** per la finitura brill spazzolato e laccato opaco colore (da specificare nell'ordine).

- *In the TECNO door, the handle is built-in along the length of the door: available in white finish, with increase of **35 euros** for the brushed brill finish and colour matt lacquer (to be specified in the order).*

**SLIDE**  
lacc. opaco base  
basic matt lacq.



**SLIDE**  
lacc. opaco colore  
colour matt lacq.



**SLIDE**  
rovere lacc. poro aperto  
open pore lacq. oak



**SLIDE**  
lacc. lucido  
glossy lacq.



**SLIDE**  
rovere nodi  
oak knots



**SLIDE**  
rovere termotrattato  
heat-treated oak



**Sezione ante | Door section:**











L. 1475	H. H.	CODICE CODE	EL. 2 ANTE da 740 mm EL. 2 DOORS 740 mm					
			1.314	1.421	1.906	1.926	1.629	1.790
		2228 EMAS2130	1.314	1.421	1.906	1.926	1.629	1.790
		2356 EMAS3130	1.345	1.451	1.964	1.985	1.672	1.840
		2580 EMAS4130	1.397	1.509	2.065	2.092	1.750	1.929
L. 2037	H. H.	CODICE CODE	EL. 2 ANTE da 1021 mm EL. 2 DOORS 1021 mm					
			1.612	1.745	2.274	2.384	1.939	2.124
		2228 EMAS2200	1.612	1.745	2.274	2.384	1.939	2.124
		2356 EMAS3200	1.639	1.777	2.336	2.449	1.980	2.172
		2580 EMAS4200	1.721	1.869	2.469	2.602	2.082	2.293
L. 2525	H. H.	CODICE CODE	EL. 2 ANTE da 1265 mm EL. 2 DOORS 1265 mm					
			1.924	2.075	2.692	2.812	2.299	2.496
		2228 EMAS2230	1.924	2.075	2.692	2.812	2.299	2.496
		2356 EMAS3230	1.959	2.119	2.770	2.893	2.344	2.554
		2580 EMAS4230	2.055	2.225	2.929	3.072	2.460	2.697

Ulteriori combinazioni di aperture e finiture sono possibili utilizzando le scocche vuote a pag. | Additional finishes and opening combinations are possible using the empty bodies on page 168

# SCORREVOLE | SLIDING DOOR

incisa, onda, tecno

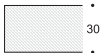
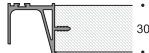
INCISA rovere lacc. poro aperto <i>open pore lacq. oak</i>	ONDA rovere lacc. poro aperto <i>open pore lacq. oak</i>	TECNO lacc. opaco base <i>basic matt lacq.</i>	TECNO lacc. opaco colore <i>colour matt lacq.</i>	TECNO rovere lacc. poro aperto <i>open pore lacq. oak</i>	TECNO lacc. lucido <i>glossy lacq.</i>	TECNO rovere nodi <i>oak knots</i>	TECNO rovere termotrattato <i>heat-treated oak</i>		Maggiorazione per interno laccato opaco  <i>Increase for matt lacquered inside finish</i>
									
									
EL. 2 ANTE da 740 mm <i>EL. 2 DOORS 740 mm</i>									
		<b>1.400</b>	<b>1.511</b>	<b>1.988</b>	<b>2.024</b>	<b>1.727</b>	<b>1.884</b>		<b>349</b>
		<b>1.425</b>	<b>1.539</b>	<b>2.044</b>	<b>2.079</b>	<b>1.766</b>	<b>1.934</b>		<b>368</b>
		<b>1.483</b>	<b>1.601</b>	<b>2.147</b>	<b>2.190</b>	<b>1.850</b>	<b>2.033</b>		<b>391</b>
EL. 2 ANTE da 1021 mm <i>EL. 2 DOORS 1021 mm</i>									
		<b>1.678</b>	<b>1.809</b>	<b>2.370</b>	<b>2.480</b>	<b>2.029</b>	<b>2.214</b>		<b>427</b>
<b>2.458</b>	<b>2.562</b>	<b>1.705</b>	<b>1.841</b>	<b>2.432</b>	<b>2.543</b>	<b>2.070</b>	<b>2.262</b>		<b>448</b>
<b>2.595</b>	<b>2.697</b>	<b>1.789</b>	<b>1.933</b>	<b>2.545</b>	<b>2.666</b>	<b>2.186</b>	<b>2.387</b>		<b>473</b>
EL. 2 ANTE da 1265 mm <i>EL. 2 DOORS 1265 mm</i>									
		<b>2.000</b>	<b>2.151</b>	<b>2.760</b>	<b>2.886</b>	<b>2.387</b>	<b>2.582</b>		<b>491</b>
<b>2.900</b>	<b>3.004</b>	<b>2.037</b>	<b>2.193</b>	<b>2.838</b>	<b>2.961</b>	<b>2.426</b>	<b>2.640</b>		<b>516</b>
<b>3.065</b>	<b>3.167</b>	<b>2.137</b>	<b>2.303</b>	<b>3.007</b>	<b>3.142</b>	<b>2.582</b>	<b>2.797</b>		<b>541</b>

Ulteriori combinazioni di aperture e finiture sono possibili utilizzando le scocche vuote a pag. | *Additional finishes and opening combinations are possible using the empty bodies on page 168*

# SCORREVOLE | SLIDING DOOR

## slide

- **Attenzione:** la finitura dei fianchi segue la finitura dell'anta (ES: anta rovere lacc. poro aperto - fianco rovere lacc. poro aperto / anta lacc. opaco base - fianco lacc. opaco base).  
 - **Attention:** the finish of the sides follows the finish of the door (EX. open pore lacq. oak door - open pore lacq. oak side / basic matt lacq. door - basic matt lacq. side).

- **Prezzi calcolati con interno melaminico.**

**Dotazione interna vano standard:** - N. 1 ripiano - N. 2 tubi appendiabiti

- **Prices calculated with melamine inside finish.**

**Standard internal equipment:** - 1 shelf - 2 clothes hangers

- **Maniglie a pag. | Handles on page 89**

- **Nell'anta TECNO la maniglia è inserita per tutta la lunghezza dell'anta:** disponibile in finitura bianco, con maggiorazione di **35 euro** per la finitura brill spazzolato e laccato opaco colore (da specificare nell'ordine).

- **In the TECNO door, the handle is built-in along the length of the door:** available in white finish, with increase of **35 euros** for the brushed brill finish and colour matt lacquer (to be specified in the order).

**SLIDE**  
lacc. opaco base  
basic matt lacq.



**SLIDE**  
lacc. opaco colore  
colour matt lacq.



**SLIDE**  
rovere lacc. poro aperto  
open pore lacq. oak



**SLIDE**  
lacc. lucido  
glossy lacq.



**SLIDE**  
rovere nodi  
oak knots



**SLIDE**  
rovere termotrattato  
heat-treated oak



**Sezione ante | Door section:**









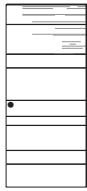

Model	H. H.	CODICE CODE	EL. 3 ANTE da 740 mm EL. 3 DOORS 740 mm								
L. 2200 				2228	EMAS2210	<b>1.896</b>	<b>2.039</b>	<b>2.689</b>	<b>2.720</b>	<b>2.319</b>	<b>2.525</b>
				2356	EMAS3210	<b>1.938</b>	<b>2.083</b>	<b>2.768</b>	<b>2.802</b>	<b>2.377</b>	<b>2.594</b>
				2580	EMAS4210	<b>2.010</b>	<b>2.162</b>	<b>2.905</b>	<b>2.945</b>	<b>2.485</b>	<b>2.713</b>
L. 3043 				2228	EMAS2300	<b>2.343</b>	<b>2.525</b>	<b>3.241</b>	<b>3.407</b>	<b>2.784</b>	<b>3.026</b>
				2356	EMAS3300	<b>2.379</b>	<b>2.572</b>	<b>3.326</b>	<b>3.498</b>	<b>2.839</b>	<b>3.092</b>
				2580	EMAS4300	<b>2.496</b>	<b>2.702</b>	<b>3.511</b>	<b>3.710</b>	<b>2.983</b>	<b>3.259</b>
L. 3775 				2228	EMAS2360	<b>2.811</b>	<b>3.020</b>	<b>3.868</b>	<b>4.049</b>	<b>3.324</b>	<b>3.584</b>
				2356	EMAS3360	<b>2.859</b>	<b>3.085</b>	<b>3.977</b>	<b>4.164</b>	<b>3.385</b>	<b>3.665</b>
				2580	EMAS4360	<b>2.997</b>	<b>3.236</b>	<b>4.201</b>	<b>4.415</b>	<b>3.350</b>	<b>3.865</b>
L. 4049 				2228	EMAS2400	<b>3.075</b>	<b>3.309</b>	<b>4.215</b>	<b>4.437</b>	<b>3.633</b>	<b>3.933</b>
				2356	EMAS3400	<b>3.122</b>	<b>3.370</b>	<b>4.324</b>	<b>4.554</b>	<b>3.704</b>	<b>4.016</b>
				2580	EMAS4400	<b>3.274</b>	<b>3.540</b>	<b>4.562</b>	<b>4.828</b>	<b>3.890</b>	<b>4.232</b>

Ulteriori combinazioni di aperture e finiture sono possibili utilizzando le scocche vuote a pag. | Additional finishes and opening combinations are possible using the empty bodies on page 168

# SCORREVOLE | SLIDING DOOR

incisa, onda, tecno

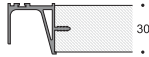
INCISA rovere lacc. poro aperto <i>open pore lacq. oak</i>	ONDA rovere lacc. poro aperto <i>open pore lacq. oak</i>	TECNO lacc. opaco base <i>basic matt lacq.</i>	TECNO lacc. opaco colore <i>colour matt lacq.</i>	TECNO rovere lacc. poro aperto <i>open pore lacq. oak</i>	TECNO lacc. lucido <i>glossy lacq.</i>	TECNO rovere nodi <i>oak knots</i>	TECNO rovere termotrattato <i>heat-treated oak</i>		Maggiorazione per interno laccato opaco  <i>Increase for matt lacquered inside finish</i>
									
EL. 3 ANTE da 740 mm <i>EL. 3 DOORS 740 mm</i>									
		<b>2.025</b>	<b>2.174</b>	<b>2.812</b>	<b>2.867</b>	<b>2.466</b>	<b>2.666</b>		<b>519</b>
		<b>2.058</b>	<b>2.215</b>	<b>2.888</b>	<b>2.943</b>	<b>2.518</b>	<b>2.735</b>		<b>544</b>
		<b>2.139</b>	<b>2.300</b>	<b>3.028</b>	<b>3.092</b>	<b>2.635</b>	<b>2.869</b>		<b>579</b>
EL. 3 ANTE da 1021 mm <i>EL. 3 DOORS 1021 mm</i>									
		<b>2.442</b>	<b>2.621</b>	<b>3.385</b>	<b>3.551</b>	<b>2.919</b>	<b>3.161</b>		<b>636</b>
<b>3.509</b>	<b>3.665</b>	<b>2.478</b>	<b>2.668</b>	<b>3.470</b>	<b>3.639</b>	<b>2.974</b>	<b>3.227</b>		<b>664</b>
<b>3.700</b>	<b>3.853</b>	<b>2.598</b>	<b>2.798</b>	<b>3.625</b>	<b>3.806</b>	<b>3.139</b>	<b>3.400</b>		<b>702</b>
EL. 3 ANTE da 1265 mm <i>EL. 3 DOORS 1265 mm</i>									
		<b>2.925</b>	<b>3.134</b>	<b>3.970</b>	<b>4.160</b>	<b>3.456</b>	<b>3.713</b>		<b>732</b>
<b>4.172</b>	<b>4.328</b>	<b>2.976</b>	<b>3.196</b>	<b>4.079</b>	<b>4.266</b>	<b>3.508</b>	<b>3.794</b>		<b>766</b>
<b>4.405</b>	<b>4.558</b>	<b>3.120</b>	<b>3.353</b>	<b>4.318</b>	<b>4.520</b>	<b>3.733</b>	<b>4.015</b>		<b>804</b>
EL. 4 ANTE da 1021 mm <i>EL. 4 DOORS 1021 mm</i>									
		<b>3.207</b>	<b>3.437</b>	<b>4.407</b>	<b>4.629</b>	<b>3.813</b>	<b>4.113</b>		<b>846</b>
<b>4.568</b>	<b>4.776</b>	<b>3.254</b>	<b>3.498</b>	<b>4.516</b>	<b>4.742</b>	<b>3.884</b>	<b>4.196</b>		<b>882</b>
<b>4.814</b>	<b>5.018</b>	<b>3.410</b>	<b>3.668</b>	<b>4.714</b>	<b>4.956</b>	<b>4.098</b>	<b>4.420</b>		<b>934</b>

Ulteriori combinazioni di aperture e finiture sono possibili utilizzando le scocche vuote a pag. | *Additional finishes and opening combinations are possible using the empty bodies on page 168*

# SCORREVOLE | SLIDING DOOR

## telaio "O"

VETRI: cat. 1 sabbia chiara, sabbia scura, corda, grigio pietra, grigio chiaro, grigio medio, grigio polvere, blu piombo, giallo cromo, verde pompelmo, rosso rubino, nero, stopsol fumé, specchio, specchio bronzo, specchio fumo. cat. 2 bianco, magnolia.

- Fianchi e divisioni a pag. | Side panels and partitions on page 96

- Prezzi calcolati con interno melaminico.

Dotazione interna vano standard: - N. 1 ripiano - N. 2 tubi appendiabiti

- Prices calculated with melamine inside finish.





Standard internal equipment: - 1 shelf - 2 clothes hangers

- Il telaio dell'anta permette la presa senza bisogno di maniglia.

Telaio in alluminio disponibile in finitura bianco, con maggiorazione per la finitura brill spazzolato e laccato opaco colore di 96 euro per modulo (da specificare nell'ordine).

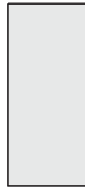

- The door frame allows the opening without the need of a handle.

Aluminium frame available in white finish, with increase for the brushed brill finish and colour matt lacquer of 96 euro per module (to be specified in the order).

TELAIO "O" lacc. opaco base basic matt lacq.	TELAIO "O" lacc. opaco colore colour matt lacq.	TELAIO "O" essenza wood	TELAIO "O" rovere lacc. poro aperto open pore lacq. oak	TELAIO "O" lacc. lucido glossy lacq.	TELAIO "O" vetro cat. 1 glass cat. 1
					

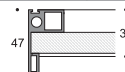
Sezione ante | Door section:

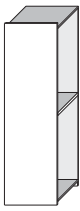
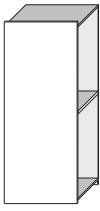
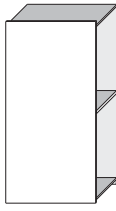

L. 700	H. H.	CODICE CODE	EL. 1 ANTA da 740 mm - escluso di fianchi e divisioni EL. 1 DOOR 740 mm - side panels and partitions not included	648	664	773	836	823	813
 700		2356 EMMSO345							
		2580 EMMSO445		660	677	794	862	849	838
L. 981	H. H.	CODICE CODE	EL. 1 ANTA da 1021 mm - escluso di fianchi e divisioni EL. 1 DOOR 1021 mm - side panels and partitions not included	757	779	920	1.005	994	984
 981		2356 EMMSO355							
		2580 EMMSO455		773	796	947	1.041	1.031	1.021
L. 1225	H. H.	CODICE CODE	EL. 1 ANTA da 1265 mm - escluso di fianchi e divisioni EL. 1 DOOR 1265 mm - side panels and partitions not included	919	945	1.114	1.220	1.210	1.200
 1225		2356 EMMSO365							
		2580 EMMSO465		940	968	1.150	1.266	1.258	1.247
L. 1425	H. H.	CODICE CODE	EL. 1 ANTA da 1465 mm - escluso di fianchi e divisioni EL. 1 DOOR 1465 mm - side panels and partitions not included						1.326
 1425		2356 EMMSO375							
		2580 EMMSO475							1.379

Ulteriori combinazioni di aperture e finiture sono possibili utilizzando le scocche vuote a pag. | Additional finishes and opening combinations are possible using the empty bodies on page 168



# SCORREVOLE | SLIDING DOOR

## telaio "0"

**GLASSES: cat. 1** light sand, dark sand, rope, stone grey, light grey, medium grey, powder grey, gun metal blue, chrome yellow, grapefruit green, ruby red, black, smoke-grey stapsol, mirror, bronze mirror, smoke mirror. **cat. 2** white, magnolia.

<b>TELAIO "0"</b> <b>vetro cat. 2</b> <b>glass cat. 2</b>								Maggiorazione per interno laccato opaco  <i>Increase                      for matt lacquered                      inside finish</i>
								
EL. 1 ANTA da 740 mm - escluso di fianchi e divisioni EL. 1 DOOR 740 mm - side panels and partitions not included								
<b>950</b>								<b>96</b>
<b>988</b>								<b>101</b>
EL. 1 ANTA da 1021 mm - escluso di fianchi e divisioni EL. 1 DOOR 1021 mm - side panels and partitions not included								
<b>1.172</b>								<b>136</b>
<b>1.228</b>								<b>142</b>
EL. 1 ANTA da 1265 mm - escluso di fianchi e divisioni EL. 1 DOOR 1265 mm - side panels and partitions not included								
<b>1.435</b>								<b>170</b>
<b>1.504</b>								<b>176</b>
EL. 1 ANTA da 1465 mm - escluso di fianchi e divisioni EL. 1 DOOR 1465 mm - side panels and partitions not included								
<b>1.529</b>								<b>189</b>
<b>1.600</b>								<b>199</b>

Ulteriori combinazioni di aperture e finiture sono possibili utilizzando le scocche vuote a pag. | Additional finishes and opening combinations are possible using the empty bodies on page 168

# SCORREVOLE | SLIDING DOOR

## telaiο "O"

VETRI: cat. 1 sabbia chiaro, sabbia scuro, corda, grigio pietra, grigio chiaro, grigio medio, grigio polvere, blu piombo, giallo cromo, verde pompelmo, rosso rubino, nero, stopsol fumé, specchio, specchio bronzo, specchio fumo. cat. 2 bianco, magnolia.

- **Attenzione: la finitura dei fianchi segue la finitura dell'anta (ES: anta essenza - fianco essenza / anta vetro - fianco lacc. opaco base).**  
 - *Attention: the finish of the sides follows the finish of the door (EX. wooden door - wooden side / glass door - basic matt lacq. side).*  
 - **Prezzi calcolati con interno melaminico.**  
 Dotazione interna vano standard: - N. 1 ripiano - N. 2 tubi appendiabiti  
 - *Prices calculated with melamine inside finish.*  
 Standard internal equipment: - 1 shelf - 2 clothes hangers  
 - **Il telaio dell'anta permette la presa senza bisogno di maniglia.**  
 Telaio in alluminio disponibile in finitura bianco, con maggiorazione per la finitura brill spazzolato e laccato opaco colore di **96 euro per modulo (da specificare nell'ordine).**  
 - *The door frame allows the opening without the need of a handle.*  
 Aluminium frame available in white finish, with increase for the brushed brill finish and colour matt lacquer of **96 euro per modulo (to be specified in the order).**



Sezione ante | Door section:

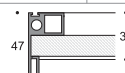

Model	Dimensions	Code	EL. 2 ANTE da 740 mm EL. 2 DOORS 740 mm	EL. 2 ANTE da 1021 mm EL. 2 DOORS 1021 mm	EL. 2 ANTE da 1265 mm EL. 2 DOORS 1265 mm	EL. 2 ANTE da 1465 mm EL. 2 DOORS 1465 mm			
L. 1475		H. H. CODICE CODE	2356 EMAS3130	1.617	1.677	1.964	2.180	2.151	1.947
			2580 EMAS4130	1.661	1.723	2.032	2.267	2.240	2.017
L. 2037		H. H. CODICE CODE	2356 EMAS3200	1.835	1.907	2.258	2.518	2.493	2.289
			2580 EMAS4200	1.887	1.961	2.338	2.625	2.604	2.383
L. 2525		H. H. CODICE CODE	2356 EMAS3230	2.159	2.239	2.646	2.948	2.925	2.721
			2580 EMAS4230	2.221	2.305	2.744	3.075	3.058	2.835
L. 2925		H. H. CODICE CODE	2356 EMAS3280						2.973
			2580 EMAS4280						

Ulteriori combinazioni di aperture e finiture sono possibili utilizzando le scocche vuote a pag. | Additional finishes and opening combinations are possible using the empty bodies on page 168

# SCORREVOLE | SLIDING DOOR

## telaiο "0"

GLASSES: **cat. 1** light sand, dark sand, rope, stone grey, light grey, medium grey, powder grey, gun metal blue, chrome yellow, grapefruit green, ruby red, black, smoke-grey stapsol, mirror, bronze mirror, smoke mirror. **cat. 2** white, magnolia.

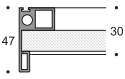
<p><b>TELAIO "0"</b> vetro <b>cat. 2</b> glass <b>cat. 2</b></p>  		<p>Maggiorazione per interno laccato opaco</p> <p><i>Increase for matt lacquered inside finish</i></p>
<p>EL. 2 ANTE da 740 mm EL. 2 DOORS 740 mm</p>		
<p><b>2.221</b></p>		<p><b>368</b></p>
<p><b>2.317</b></p>		<p><b>391</b></p>
<p>EL. 2 ANTE da 1021 mm EL. 2 DOORS 1021 mm</p>		
<p><b>2.665</b></p>		<p><b>448</b></p>
<p><b>2.797</b></p>		<p><b>473</b></p>
<p>EL. 2 ANTE da 1265 mm EL. 2 DOORS 1265 mm</p>		
<p><b>3.191</b></p>		<p><b>516</b></p>
<p><b>3.349</b></p>		<p><b>541</b></p>
<p>EL. 2 ANTE da 1465 mm EL. 2 DOORS 1465 mm</p>		
<p><b>3.379</b></p>		<p><b>554</b></p>
<p><b>3.541</b></p>		<p><b>587</b></p>

Ulteriori combinazioni di aperture e finiture sono possibili utilizzando le scocche vuote a pag. | Additional finishes and opening combinations are possible using the empty bodies on page 168



# SCORREVOLE | SLIDING DOOR

## telaio "0"

GLASSES: **cat. 1** light sand, dark sand, rope, stone grey, light grey, medium grey, powder grey, gun metal blue, chrome yellow, grapefruit green, ruby red, black, smoke-grey stapsol, mirror, bronze mirror, smoke mirror. **cat. 2** white, magnolia.

<b>TELAIO "0"</b> <b>vetro cat. 2</b> <b>glass cat. 2</b>									Maggiorazione per interno laccato opaco  <i>Increase            for matt lacquered            inside finish</i>
									
EL. 3 ANTE da 740 mm EL. 3 DOORS 740 mm									
<b>3.252</b>									<b>544</b>
<b>3.390</b>									<b>579</b>
EL. 3 ANTE da 1021 mm EL. 3 DOORS 1021 mm									
<b>3.918</b>									<b>664</b>
<b>4.110</b>									<b>702</b>
EL. 3 ANTE da 1265 mm EL. 3 DOORS 1265 mm									
<b>4.707</b>									<b>766</b>
<b>4.938</b>									<b>804</b>
EL. 4 ANTE da 1021 mm EL. 4 DOORS 1021 mm									
<b>5.174</b>									<b>882</b>
<b>5.426</b>									<b>934</b>

Ulteriori combinazioni di aperture e finiture sono possibili utilizzando le scocche vuote a pag. | Additional finishes and opening combinations are possible using the empty bodies on page 168

# SCORREVOLE | SLIDING DOOR

## telaiο "A"

VETRI: cat. 1 sabbia chiaro, sabbia scuro, corda, grigio pietra, grigio chiaro, grigio medio, grigio polvere, blu piombo, giallo cromo, verde pompelmo, rosso rubino, nero, stopsol fumé, specchio, specchio bronzo, specchio fumo. cat. 2 bianco, magnolia.

- Fianchi e divisioni a pag. | Side panels and partitions on page 96

- Prezzi calcolati con interno melaminico.

Dotazione interna vano standard: - N. 1 ripiano - N. 2 tubi appendiabiti





- Prices calculated with melamine inside finish.

Standard internal equipment: - 1 shelf - 2 clothes hangers

- Il telaio dell'anta permette la presa senza bisogno di maniglia.

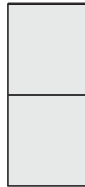

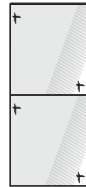
Telaio in alluminio disponibile in finitura bianco, con maggiorazione per la finitura brill spazzolato e laccato opaco colore di 103 euro per modulo (da specificare nell'ordine).

- The door frame allows the opening without the need of a handle. Aluminium frame available in white finish, with increase for the brushed brill finish and colour matt lacquer of 103 euro per module (to be specified in the order).

TELAIO "A" lacc. opaco base basic matt lacq.	TELAIO "A" lacc. opaco colore colour matt lacq.	TELAIO "A" essenza wood	TELAIO "A" rovere lacc. poro aperto open pore lacq. oak	TELAIO "A" lacc. lucido glossy lacq.	TELAIO "A" vetro cat. 1 glass cat. 1
					

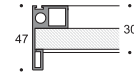
Sezione ante | Door section:

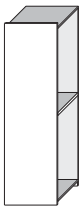
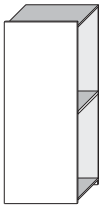
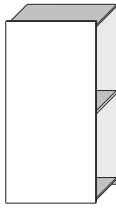

L. 700	H. H.	CODICE CODE	EL. 1 ANTA da 740 mm - escluso di fianchi e divisioni EL. 1 DOOR 740 mm - side panels and partitions not included	657	679	781	845	829	817
 700		2356 EMMSO345							
		2580 EMMSO445		669	691	803	871	857	845
L. 981	H. H.	CODICE CODE	EL. 1 ANTA da 1021 mm - escluso di fianchi e divisioni EL. 1 DOOR 1021 mm - side panels and partitions not included	768	796	932	1.016	1.006	986
 981		2356 EMMSO355							
		2580 EMMSO455		786	816	958	1.052	1.040	1.022
L. 1225	H. H.	CODICE CODE	EL. 1 ANTA da 1265 mm - escluso di fianchi e divisioni EL. 1 DOOR 1265 mm - side panels and partitions not included	933	967	1.127	1.231	1.221	1.203
 1225		2356 EMMSO365							
		2580 EMMSO465		953	991	1.161	1.277	1.267	1.249
L. 1425	H. H.	CODICE CODE	EL. 1 ANTA da 1465 mm - escluso di fianchi e divisioni EL. 1 DOOR 1465 mm - side panels and partitions not included	1.011	1.051	1.231	1.355	1.345	1.331
 1425		2356 EMMSO375							
		2580 EMMSO475		1.036	1.078	1.272	1.408	1.400	1.384

Ulteriori combinazioni di aperture e finiture sono possibili utilizzando le scocche vuote a pag. | Additional finishes and opening combinations are possible using the empty bodies on page 168

# SCORREVOLE | SLIDING DOOR

## telaio "A"

**GLASSES: cat. 1** light sand, dark sand, rope, stone grey, light grey, medium grey, powder grey, gun metal blue, chrome yellow, grapefruit green, ruby red, black, smoke-grey stapsol, mirror, bronze mirror, smoke mirror. **cat. 2** white, magnolia.

<b>TELAIO "A"</b> vetro cat. 2 glass cat. 2	<b>TELAIO "A"</b> l. opaco colore / essenza colour matt l. / wood	<b>TELAIO "A"</b> vetro 1 / l. opaco colore glass 1 / col. matt lacq.	<b>TELAIO "A"</b> vetro 2 / l. opaco colore glass 2 / col. matt lacq.	<b>TELAIO "A"</b> vetro 1 / essenza glass 1 / wood	<b>TELAIO "A"</b> vetro 2 / essenza glass 2 / wood				Maggiorazione per interno laccato opaco  Increase for matt lacquered inside finish
EL. 1 ANTA da 740 mm - escluso di fianchi e divisioni EL. 1 DOOR 740 mm - side panels and partitions not included									
<b>955</b>	<b>730</b>	<b>748</b>	<b>817</b>	<b>799</b>	<b>868</b>				<b>96</b>
<b>995</b>	<b>747</b>	<b>768</b>	<b>843</b>	<b>824</b>	<b>899</b>				<b>101</b>
EL. 1 ANTA da 1021 mm - escluso di fianchi e divisioni EL. 1 DOOR 1021 mm - side panels and partitions not included									
<b>1.178</b>	<b>864</b>	<b>891</b>	<b>987</b>	<b>959</b>	<b>1.055</b>				<b>136</b>
<b>1.232</b>	<b>887</b>	<b>919</b>	<b>1.024</b>	<b>990</b>	<b>1.095</b>				<b>142</b>
EL. 1 ANTA da 1265 mm - escluso di fianchi e divisioni EL. 1 DOOR 1265 mm - side panels and partitions not included									
<b>1.441</b>	<b>1.047</b>	<b>1.085</b>	<b>1.204</b>	<b>1.165</b>	<b>1.284</b>				<b>170</b>
<b>1.509</b>	<b>1.076</b>	<b>1.120</b>	<b>1.250</b>	<b>1.205</b>	<b>1.335</b>				<b>176</b>
EL. 1 ANTA da 1465 mm - escluso di fianchi e divisioni EL. 1 DOOR 1465 mm - side panels and partitions not included									
<b>1.605</b>	<b>1.141</b>	<b>1.191</b>	<b>1.328</b>	<b>1.281</b>	<b>1.418</b>				<b>189</b>
<b>1.684</b>	<b>1.175</b>	<b>1.231</b>	<b>1.381</b>	<b>1.328</b>	<b>1.478</b>				<b>199</b>

Ulteriori combinazioni di aperture e finiture sono possibili utilizzando le scocche vuote a pag. | Additional finishes and opening combinations are possible using the empty bodies on page 168

# SCORREVOLE | SLIDING DOOR

## telaiο "A"

**VETRI: cat. 1** sabbia chiara, sabbia scura, corda, grigio pietra, grigio chiaro, grigio medio, grigio polvere, blu piombo, giallo cromo, verde pompelmo, rosso rubino, nero, stopsol fumé, specchio, specchio bronzo, specchio fumo. **cat. 2** bianco, magnolia.

- **Attenzione: la finitura dei fianchi segue la finitura dell'anta (ES: anta mista - fianco come pannello inferiore / anta vetro - fianco lacc. opaco base).**
- **Attention: the finish of the sides follows the finish of the door (EX. mixed door - side like lower panel / glass door - basic matt lacq. side).**
- **Prezzi calcolati con interno melaminico.**
- **Dotazione interna vano standard: - N. 1 ripiano - N. 2 tubi appendiabiti**
- **Prices calculated with melamine inside finish.**
- **Standard internal equipment: - 1 shelf - 2 clothes hangers**
- **Il telaio dell'anta permette la presa senza bisogno di maniglia.**
- **Telaio in alluminio disponibile in finitura bianco, con maggiorazione per la finitura brill spazzolato e laccato opaco colore di 103 euro per modulo (da specificare nell'ordine).**
- **The door frame allows the opening without the need of a handle.**
- **Alluminium frame available in white finish, with increase for the brushed brill finish and colour matt lacquer of 103 euro per module (to be specified in the order).**

**TELAIO "A"**  
lacc. opaco base  
basic matt lacq.



**TELAIO "A"**  
lacc. opaco colore  
colour matt lacq.

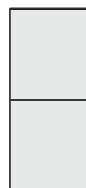

**TELAIO "A"**  
essenza  
wood



**TELAIO "A"**  
rovere lacc. poro aperto  
open pore lacq. oak



**TELAIO "A"**  
lacc. lucido  
glossy lacq.



**TELAIO "A"**  
vetro cat. 1  
glass cat. 1



Sezione ante | Door section:

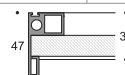

Model	Dimensions	Code	EL. 2 ANTE da 740 mm EL. 2 DOORS 740 mm	EL. 2 ANTE da 1021 mm EL. 2 DOORS 1021 mm	EL. 2 ANTE da 1265 mm EL. 2 DOORS 1265 mm	EL. 2 ANTE da 1465 mm EL. 2 DOORS 1465 mm			
L. 1475		H. H. CODICE CODE	2356 EMAS3130	1.635	1.707	1.980	2.198	2.163	1.955
			2580 EMAS4130	1.679	1.751	2.050	2.285	2.256	2.031
L. 2037		H. H. CODICE CODE	2356 EMAS3200	1.857	1.941	2.282	2.540	2.517	2.293
			2580 EMAS4200	1.913	2.001	2.360	2.647	2.622	2.385
L. 2525		H. H. CODICE CODE	2356 EMAS3230	2.187	2.283	2.672	2.970	2.947	2.727
			2580 EMAS4230	2.247	2.351	2.766	3.097	3.076	2.839
L. 2925		H. H. CODICE CODE	2356 EMAS3280	2.343	2.451	2.880	3.218	3.195	2.983
			2580 EMAS4280	2.413	2.525	2.988	3.359	3.342	3.109







Ulteriori combinazioni di aperture e finiture sono possibili utilizzando le scocche vuote a pag. | Additional finishes and opening combinations are possible using the empty bodies on page 168



# SCORREVOLE | SLIDING DOOR

## telaio "A"

GLASSES: **cat. 1** light sand, dark sand, rope, stone grey, light grey, medium grey, powder grey, gun metal blue, chrome yellow, grapefruit green, ruby red, black, smoke-grey stapsol, mirror, bronze mirror, smoke mirror. **cat. 2** white, magnolia.

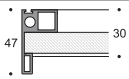
TELAIO "A" vetro cat. 2 glass cat. 2	TELAIO "A" l. opaco colore / essenza colour matt l. / wood	TELAIO "A" vetro 1 / l. opaco colore glass 1 / col. matt lacq.	TELAIO "A" vetro 2 / l. opaco colore glass 2 / col. matt lacq.	TELAIO "A" vetro 1 / essenza glass 1 / wood	TELAIO "A" vetro 2 / essenza glass 2 / wood				Maggiorazione per interno laccato opaco  Increase for matt lacquered inside finish
									
									
EL. 2 ANTE da 740 mm EL. 2 DOORS 740 mm									
<b>2.231</b>	<b>1.878</b>	<b>1.845</b>	<b>1.983</b>	<b>2.016</b>	<b>2.154</b>				<b>368</b>
<b>2.331</b>	<b>1.938</b>	<b>1.905</b>	<b>2.055</b>	<b>2.092</b>	<b>2.242</b>				<b>391</b>
EL. 2 ANTE da 1021 mm EL. 2 DOORS 1021 mm									
<b>2.677</b>	<b>2.146</b>	<b>2.131</b>	<b>2.323</b>	<b>2.336</b>	<b>2.528</b>				<b>448</b>
<b>2.805</b>	<b>2.218</b>	<b>2.207</b>	<b>2.417</b>	<b>2.424</b>	<b>2.634</b>				<b>473</b>
EL. 2 ANTE da 1265 mm EL. 2 DOORS 1265 mm									
<b>3.203</b>	<b>2.512</b>	<b>2.519</b>	<b>2.757</b>	<b>2.748</b>	<b>2.986</b>				<b>516</b>
<b>3.359</b>	<b>2.596</b>	<b>2.609</b>	<b>2.869</b>	<b>2.854</b>	<b>3.114</b>				<b>541</b>
EL. 2 ANTE da 1465 mm EL. 2 DOORS 1465 mm									
<b>3.531</b>	<b>2.700</b>	<b>2.731</b>	<b>3.005</b>	<b>2.980</b>	<b>3.254</b>				<b>554</b>
<b>3.709</b>	<b>2.794</b>	<b>2.831</b>	<b>3.131</b>	<b>3.100</b>	<b>3.400</b>				<b>587</b>





Ulteriori combinazioni di aperture e finiture sono possibili utilizzando le scocche vuote a pag. | Additional finishes and opening combinations are possible using the empty bodies on page 168

# SCORREVOLE | SLIDING DOOR

## telaiο "A"

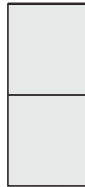
**VETRI: cat. 1** sabbia chiara, sabbia scura, corda, grigio pietra, grigio chiaro, grigio medio, grigio polvere, blu piombo, giallo cromo, verde pompelmo, rosso rubino, nero, stopsol fumé, specchio, specchio bronzo, specchio fumo. **cat. 2** bianco, magnolia.

- **Attenzione: la finitura dei fianchi segue la finitura dell'anta (ES: anta mista - fianco come pannello inferiore / anta vetro - fianco lacc. opaco base).**
- **Attention: the finish of the sides follows the finish of the door (EX. mixed door - side like lower panel / glass door - basic matt lacq. side).**
- **Prezzi calcolati con interno melaminico.**
- **Dotazione interna vano standard: - N. 1 ripiano - N. 2 tubi appendiabiti**
- **Prices calculated with melamine inside finish.**
- **Standard internal equipment: - 1 shelf - 2 clothes hangers**
- **Il telaio dell'anta permette la presa senza bisogno di maniglia.**
- **Telaio in alluminio disponibile in finitura bianco, con maggiorazione per la finitura brill spazzolato e laccato opaco colore di 103 euro per modulo (da specificare nell'ordine).**
- **The door frame allows the opening without the need of a handle.**
- **Alluminium frame available in white finish, with increase for the brushed brill finish and colour matt lacquer of 103 euro per module (to be specified in the order).**

TELAIO "A" lacc. opaco base basic matt lacq.	TELAIO "A" lacc. opaco colore colour matt lacq.	TELAIO "A" essenza wood	TELAIO "A" rovere lacc. poro aperto open pore lacq. oak	TELAIO "A" lacc. lucido glossy lacq.	TELAIO "A" vetro cat. 1 glass cat. 1
					

### Sezione ante | Door section:

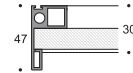

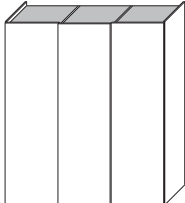
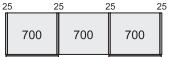
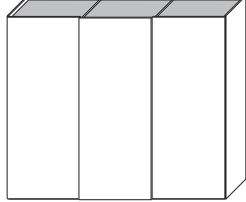
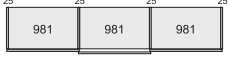
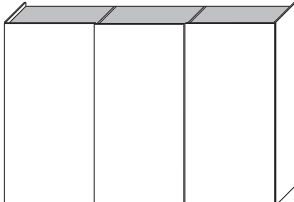
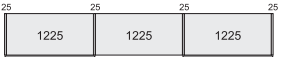
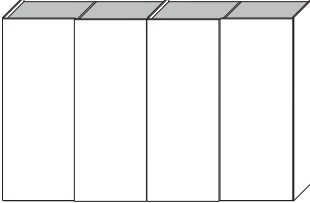
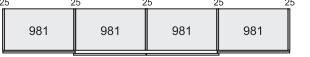





L. 2200	H. H.	CODICE CODE	EL. 3 ANTE da 740 mm EL. 3 DOORS 740 mm						
			2356	EMAS3210	2.373	2.467	2.839	3.119	3.069
 		EMAS4210	2580	2.433	2.525	2.935	3.235	3.191	2.961
L. 3043	H. H.	CODICE CODE	EL. 3 ANTE da 1021 mm EL. 3 DOORS 1021 mm						
			2356	EMAS3300	2.706	2.818	3.292	3.632	3.600
 		EMAS4300	2580	2.784	2.900	3.400	3.778	3.740	3.492
L. 3775	H. H.	CODICE CODE	EL. 3 ANTE da 1265 mm EL. 3 DOORS 1265 mm						
			2356	EMAS3360	3.201	3.331	3.877	4.277	4.245
 		EMAS4360	2580	3.285	3.425	4.009	4.453	4.421	4.173
L. 4049	H. H.	CODICE CODE	EL. 4 ANTE da 1021 mm EL. 4 DOORS 1021 mm						
			2356	EMAS3400	3.558	3.698	4.308	4.732	4.690
 		EMAS4400	2580	3.658	3.804	4.446	4.918	4.868	4.602

Ulteriori combinazioni di aperture e finiture sono possibili utilizzando le scocche vuote a pag. | Additional finishes and opening combinations are possible using the empty bodies on page 168

# SCORREVOLE | SLIDING DOOR

## telaio "A"

GLASSES: **cat. 1** light sand, dark sand, rope, stone grey, light grey, medium grey, powder grey, gun metal blue, chrome yellow, grapefruit green, ruby red, black, smoke-grey stapsol, mirror, bronze mirror, smoke mirror. **cat. 2** white, magnolia.

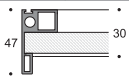
TELAIO "A" vetro cat. 2 glass cat. 2	TELAIO "A" l. opaco colore / essenza colour matt l. / wood	TELAIO "A" vetro 1 / l. opaco colore glass 1 / col. matt lacq.	TELAIO "A" vetro 2 / l. opaco colore glass 2 / col. matt lacq.	TELAIO "A" vetro 1 / essenza glass 1 / wood	TELAIO "A" vetro 2 / essenza glass 2 / wood				Maggiorazione per interno laccato opaco  Increase for matt lacquered inside finish
									
									
EL. 3 ANTE da 740 mm EL. 3 DOORS 740 mm									
<b>3.267</b>	<b>2.686</b>	<b>2.674</b>	<b>2.881</b>	<b>2.893</b>	<b>3.100</b>				<b>544</b>
<b>3.411</b>	<b>2.767</b>	<b>2.756</b>	<b>2.981</b>	<b>2.998</b>	<b>3.223</b>				<b>579</b>
EL. 3 ANTE da 1021 mm EL. 3 DOORS 1021 mm									
<b>3.936</b>	<b>3.088</b>	<b>3.103</b>	<b>3.391</b>	<b>3.373</b>	<b>3.661</b>				<b>664</b>
<b>4.122</b>	<b>3.187</b>	<b>3.209</b>	<b>3.524</b>	<b>3.496</b>	<b>3.811</b>				<b>702</b>
EL. 3 ANTE da 1265 mm EL. 3 DOORS 1265 mm									
<b>4.725</b>	<b>3.637</b>	<b>3.685</b>	<b>4.042</b>	<b>3.991</b>	<b>4.348</b>				<b>766</b>
<b>4.953</b>	<b>3.754</b>	<b>3.812</b>	<b>4.202</b>	<b>4.141</b>	<b>4.531</b>				<b>804</b>
EL. 4 ANTE da 1021 mm EL. 4 DOORS 1021 mm									
<b>5.198</b>	<b>4.036</b>	<b>4.078</b>	<b>4.462</b>	<b>4.416</b>	<b>4.800</b>				<b>882</b>
<b>5.442</b>	<b>4.162</b>	<b>4.216</b>	<b>4.636</b>	<b>4.574</b>	<b>4.994</b>				<b>934</b>

Ulteriori combinazioni di aperture e finiture sono possibili utilizzando le scocche vuote a pag. | Additional finishes and opening combinations are possible using the empty bodies on page 168

# SCORREVOLE | SLIDING DOOR

## telaiο "C"

VETRI: cat. 1 sabbia chiaro, sabbia scuro, corda, grigio pietra, grigio chiaro, grigio medio, grigio polvere, blu piombo, giallo cromo, verde pompelmo, rosso rubino, nero, stopsol fumé, specchio, specchio bronzo, specchio fumo. cat. 2 bianco, magnolia.

- Fianchi e divisioni a pag. | Side panels and partitions on page 96

- Prezzi calcolati con interno melaminico.

Dotazione interna vano standard: - N. 1 ripiano - N. 2 tubi appendiabiti





- Prices calculated with melamine inside finish.

Standard internal equipment: - 1 shelf - 2 clothes hangers

- Il telaio dell'anta permette la presa senza bisogno di maniglia.

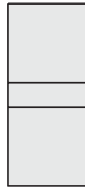
Telaio in alluminio disponibile in finitura bianco, con maggiorazione per la finitura brill spazzolato e laccato opaco colore di 111 euro per modulo (da specificare nell'ordine).

- The door frame allows the opening without the need of a handle. Aluminium frame available in white finish, with increase for the brushed brill finish and colour matt lacquer of 111 euro per module (to be specified in the order).

TELAIO "C" lacc. opaco base basic matt lacq.	TELAIO "C" lacc. opaco colore colour matt lacq.	TELAIO "C" essenza wood	TELAIO "C" rovere lacc. poro aperto open pore lacq. oak	TELAIO "C" lacc. lucido glossy lacq.	TELAIO "C" vetro cat. 1 glass cat. 1
					

Sezione ante | Door section:

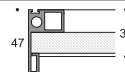

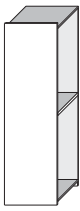
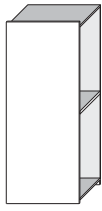
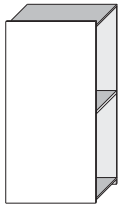
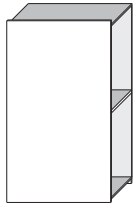
L. 700	H. H.	CODICE CODE	EL. 1 ANTA da 740 mm - escluso di fianchi e divisioni EL. 1 DOOR 740 mm - side panels and partitions not included	683	704	818	878	857	841
 700		2356 EMMS0345							
		2580 EMMS0445		696	719	837	905	886	868
L. 981	H. H.	CODICE CODE	EL. 1 ANTA da 1021 mm - escluso di fianchi e divisioni EL. 1 DOOR 1021 mm - side panels and partitions not included	801	829	970	1.054	1.037	1.013
 981		2356 EMMS0355							
		2580 EMMS0455		815	847	996	1.092	1.073	1.049
L. 1225	H. H.	CODICE CODE	EL. 1 ANTA da 1265 mm - escluso di fianchi e divisioni EL. 1 DOOR 1265 mm - side panels and partitions not included	968	1.004	1.170	1.277	1.260	1.232
 1225		2356 EMMS0365							
		2580 EMMS0465		989	1.027	1.205	1.324	1.307	1.279
L. 1425	H. H.	CODICE CODE	EL. 1 ANTA da 1465 mm - escluso di fianchi e divisioni EL. 1 DOOR 1465 mm - side panels and partitions not included	1.052	1.094	1.279	1.402	1.388	1.363
 1425		2356 EMMS0375							
		2580 EMMS0475		1.075	1.119	1.320	1.455	1.443	1.414

Ulteriori combinazioni di aperture e finiture sono possibili utilizzando le scocche vuote a pag. | Additional finishes and opening combinations are possible using the empty bodies on page 168

# SCORREVOLE | SLIDING DOOR

## telaiο "C"

**GLASSES: cat. 1** light sand, dark sand, rope, stone grey, light grey, medium grey, powder grey, gun metal blue, chrome yellow, grapefruit green, ruby red, black, smoke-grey stapsol, mirror, bronze mirror, smoke mirror. **cat. 2** white, magnolia.

TELAIO "C" vetro cat. 2 glass cat. 2	TELAIO "C" l. opaco colore / essenza colour matt l. / wood	TELAIO "C" l. opaco colore / vetro 1 col. matt lacq. / glass 1	TELAIO "C" l. opaco colore / vetro 2 col. matt lacq. / glass 2	TELAIO "C" essenza / vetro 1 wood / glass 1	TELAIO "C" essenza / vetro 2 wood / glass 2				Maggiorazione per interno laccato opaco  Increase for matt lacquered inside finish
EL. 1 ANTA da 740 mm - escluso di fianchi e divisioni EL. 1 DOOR 740 mm - side panels and partitions not included									
<b>977</b>	<b>722</b>	<b>719</b>	<b>737</b>	<b>815</b>	<b>833</b>				<b>96</b>
<b>1.016</b>	<b>737</b>	<b>734</b>	<b>752</b>	<b>834</b>	<b>852</b>				<b>101</b>
EL. 1 ANTA da 1021 mm - escluso di fianchi e divisioni EL. 1 DOOR 1021 mm - side panels and partitions not included									
<b>1.202</b>	<b>850</b>	<b>849</b>	<b>874</b>	<b>969</b>	<b>994</b>				<b>136</b>
<b>1.256</b>	<b>868</b>	<b>867</b>	<b>892</b>	<b>995</b>	<b>1.020</b>				<b>142</b>
EL. 1 ANTA da 1265 mm - escluso di fianchi e divisioni EL. 1 DOOR 1265 mm - side panels and partitions not included									
<b>1.467</b>	<b>1.030</b>	<b>1.030</b>	<b>1.061</b>	<b>1.170</b>	<b>1.201</b>				<b>170</b>
<b>1.536</b>	<b>1.053</b>	<b>1.053</b>	<b>1.084</b>	<b>1.205</b>	<b>1.236</b>				<b>176</b>
EL. 1 ANTA da 1465 mm - escluso di fianchi e divisioni EL. 1 DOOR 1465 mm - side panels and partitions not included									
<b>1.634</b>	<b>1.121</b>	<b>1.123</b>	<b>1.160</b>	<b>1.281</b>	<b>1.318</b>				<b>189</b>
<b>1.711</b>	<b>1.146</b>	<b>1.148</b>	<b>1.185</b>	<b>1.322</b>	<b>1.359</b>				<b>199</b>





Ulteriori combinazioni di aperture e finiture sono possibili utilizzando le scocche vuote a pag. | Additional finishes and opening combinations are possible using the empty bodies on page 168

# SCORREVOLE | SLIDING DOOR

## telaiο "C"

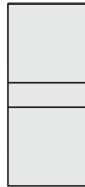
**VETRI: cat. 1** sabbia chiara, sabbia scura, corda, grigio pietra, grigio chiaro, grigio medio, grigio polvere, blu piombo, giallo cromo, verde pompelmo, rosso rubino, nero, stopsol fumé, specchio, specchio bronzo, specchio fumo. **cat. 2** bianco, magnolia.

- **Attenzione: la finitura dei fianchi segue la finitura dell'anta (ES: anta mista - fianco come pannelli grandi / anta vetro - fianco lacc. opaco base).**  
 - **Attention: the finish of the sides follows the finish of the door (EX. mixed door - side like big panels / glass door - basic matt lacq. side).**  
 - **Prezzi calcolati con interno melaminico.**  
**Dotazione interna vano standard: - N. 1 ripiano - N. 2 tubi appendiabiti**  
 - **Prices calculated with melamine inside finish.**  
**Standard internal equipment: - 1 shelf - 2 clothes hangers**  
 - **Il telaio dell'anta permette la presa senza bisogno di maniglia.**  
**Telaio in alluminio disponibile in finitura bianco, con maggiorazione per la finitura brill spazzolato e laccato opaco colore di 111 euro per modulo (da specificare nell'ordine).**  
 - **The door frame allows the opening without the need of a handle.**  
**Aluminium frame available in white finish, with increase for the brushed brill finish and colour matt lacquer of 111 euro per module (to be specified in the order).**

TELAIO "C" lacc. opaco base basic matt lacq.	TELAIO "C" lacc. opaco colore colour matt lacq.	TELAIO "C" essenza wood	TELAIO "C" rovere lacc. poro aperto open pore lacq. oak	TELAIO "C" lacc. lucido glossy lacq.	TELAIO "C" vetro cat. 1 glass cat. 1
					

Sezione ante | Door section:

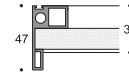

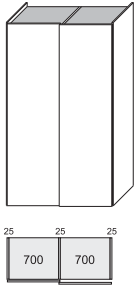
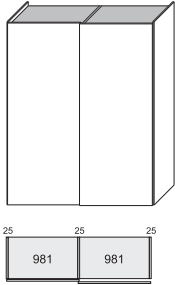
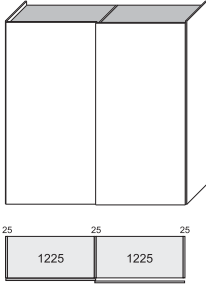
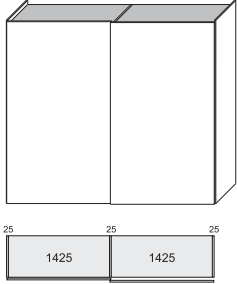





L. 1475		H. H.	CODICE CODE	EL. 2 ANTE da 740 mm EL. 2 DOORS 740 mm							
				2356	EMAS3130	1.687	1.757	2.054	2.264	2.219	2.003
				2580	EMAS4130	1.733	1.807	2.118	2.353	2.314	2.077
L. 2037		H. H.	CODICE CODE	EL. 2 ANTE da 1021 mm EL. 2 DOORS 1021 mm							
				2356	EMAS3200	1.923	2.007	2.358	2.616	2.579	2.347
				2580	EMAS4200	1.971	2.063	2.436	2.727	2.688	2.439
L. 2525		H. H.	CODICE CODE	EL. 2 ANTE da 1265 mm EL. 2 DOORS 1265 mm							
				2356	EMAS3230	2.257	2.357	2.758	3.062	3.025	2.785
				2580	EMAS4230	2.319	2.423	2.854	3.191	3.156	2.899
L. 2925		H. H.	CODICE CODE	EL. 2 ANTE da 1465 mm EL. 2 DOORS 1465 mm							
				2356	EMAS3280	2.425	2.537	2.976	3.312	3.281	3.047
				2580	EMAS4280	2.491	2.607	3.084	3.453	3.428	3.169

Ulteriori combinazioni di aperture e finiture sono possibili utilizzando le scocche vuote a pag. | Additional finishes and opening combinations are possible using the empty bodies on page 168

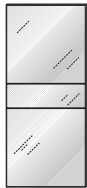
# SCORREVOLE | SLIDING DOOR

## telaio "C"

GLASSES: **cat. 1** light sand, dark sand, rope, stone grey, light grey, medium grey, powder grey, gun metal blue, chrome yellow, grapefruit green, ruby red, black, smoke-grey stapsol, mirror, bronze mirror, smoke mirror. **cat. 2** white, magnolia.

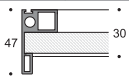
TELAIO "C" vetro cat. 2 glass cat. 2	TELAIO "C" l. opaco colore / essenza colour matt l. / wood	TELAIO "C" l. opaco colore / vetro 1 col. matt lacq. / glass 1	TELAIO "C" l. opaco colore / vetro 2 col. matt lacq. / glass 2	TELAIO "C" essenza / vetro 1 wood / glass 1	TELAIO "C" essenza / vetro 2 wood / glass 2				Maggiorazione per interno laccato opaco  Increase for matt lacquered inside finish
									
									
EL. 2 ANTE da 740 mm EL. 2 DOORS 740 mm									
<b>2.275</b>	<b>1.793</b>	<b>1.787</b>	<b>1.823</b>	<b>2.048</b>	<b>2.084</b>				<b>368</b>
<b>2.373</b>	<b>1.843</b>	<b>1.837</b>	<b>1.873</b>	<b>2.112</b>	<b>2.148</b>				<b>391</b>
EL. 2 ANTE da 1021 mm EL. 2 DOORS 1021 mm									
<b>2.725</b>	<b>2.049</b>	<b>2.047</b>	<b>2.097</b>	<b>2.356</b>	<b>2.406</b>				<b>448</b>
<b>2.853</b>	<b>2.105</b>	<b>2.103</b>	<b>2.153</b>	<b>2.434</b>	<b>2.484</b>				<b>473</b>
EL. 2 ANTE da 1265 mm EL. 2 DOORS 1265 mm									
<b>3.255</b>	<b>2.409</b>	<b>2.409</b>	<b>2.471</b>	<b>2.758</b>	<b>2.820</b>				<b>516</b>
<b>3.413</b>	<b>2.475</b>	<b>2.475</b>	<b>2.537</b>	<b>2.854</b>	<b>2.916</b>				<b>541</b>
EL. 2 ANTE da 1465 mm EL. 2 DOORS 1465 mm									
<b>3.589</b>	<b>2.591</b>	<b>2.595</b>	<b>2.669</b>	<b>2.980</b>	<b>3.054</b>				<b>554</b>
<b>3.763</b>	<b>2.661</b>	<b>2.665</b>	<b>2.739</b>	<b>3.088</b>	<b>3.162</b>				<b>587</b>





Ulteriori combinazioni di aperture e finiture sono possibili utilizzando le scocche vuote a pag. | Additional finishes and opening combinations are possible using the empty bodies on page 168

# SCORREVOLE | SLIDING DOOR

## telaiο "C"

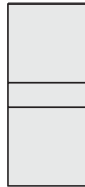
**VETRI: cat. 1** sabbia chiara, sabbia scura, corda, grigio pietra, grigio chiaro, grigio medio, grigio polvere, blu piombo, giallo cromo, verde pompelmo, rosso rubino, nero, stopsol fumé, specchio, specchio bronzo, specchio fumo. **cat. 2** bianco, magnolia.

- **Attenzione: la finitura dei fianchi segue la finitura dell'anta (ES: anta mista - fianco come pannelli grandi / anta vetro - fianco lacc. opaco base).**  
 - **Attention: the finish of the sides follows the finish of the door (EX. mixed door - side like big panels / glass door - basic matt lacq. side).**  
 - **Prezzi calcolati con interno melaminico.**  
**Dotazione interna vano standard: - N. 1 ripiano - N. 2 tubi appendiabiti**  
 - **Prices calculated with melamine inside finish.**  
**Standard internal equipment: - 1 shelf - 2 clothes hangers**  
 - **Il telaio dell'anta permette la presa senza bisogno di maniglia.**  
**Telaio in alluminio disponibile in finitura bianco, con maggiorazione per la finitura brill spazzolato e laccato opaco colore di 111 euro per modulo (da specificare nell'ordine).**  
 - **The door frame allows the opening without the need of a handle.**  
**Alluminium frame available in white finish, with increase for the brushed brill finish and colour matt lacquer of 111 euro per module (to be specified in the order).**

TELAIO "C" lacc. opaco base basic matt lacq.	TELAIO "C" lacc. opaco colore colour matt lacq.	TELAIO "C" essenza wood	TELAIO "C" rovere lacc. poro aperto open pore lacq. oak	TELAIO "C" lacc. lucido glossy lacq.	TELAIO "C" vetro cat. 1 glass cat. 1
					

Sezione ante | Door section:

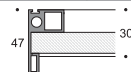

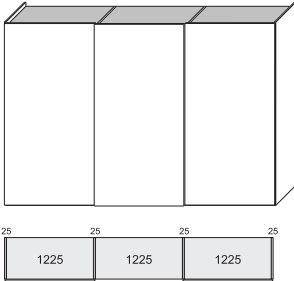
Model	H. H.	CODICE CODE	EL. 3 ANTE da 740 mm EL. 3 DOORS 740 mm	2.451	2.542	2.950	3.218	3.153	2.925	
L. 2200 				2356 EMAS3210	2.451	2.542	2.950	3.218	3.153	2.925
				2580 EMAS4210	2.514	2.609	3.037	3.337	3.278	3.030
L. 3043 			EL. 3 ANTE da 1021 mm EL. 3 DOORS 1021 mm	2356 EMAS3300	2.805	2.917	3.406	3.746	3.693	3.441
				2580 EMAS4300	2.871	2.993	3.514	3.898	3.839	3.573
L. 3775 			EL. 3 ANTE da 1265 mm EL. 3 DOORS 1265 mm	2356 EMAS3360	3.306	3.442	4.006	4.415	4.362	4.098
				2580 EMAS4360	3.393	3.533	4.141	4.594	4.541	4.263
L. 4049 			EL. 4 ANTE da 1021 mm EL. 4 DOORS 1021 mm	2356 EMAS3400	3.690	3.830	4.460	4.884	4.814	4.538
				2580 EMAS4400	3.774	3.928	4.598	5.078	5.000	4.710







Ulteriori combinazioni di aperture e finiture sono possibili utilizzando le scocche vuote a pag. | Additional finishes and opening combinations are possible using the empty bodies on page 168

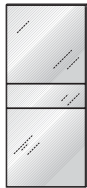

# SCORREVOLE | SLIDING DOOR

## telaio "C"

GLASSES: **cat. 1** light sand, dark sand, rope, stone grey, light grey, medium grey, powder grey, gun metal blue, chrome yellow, grapefruit green, ruby red, black, smoke-grey stapsol, mirror, bronze mirror, smoke mirror. **cat. 2** white, magnolia.

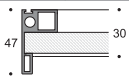
TELAIO "C" vetro cat. 2 glass cat. 2	TELAIO "C" l. opaco colore / essenza colour matt l. / wood	TELAIO "C" l. opaco colore / vetro 1 col. matt lacq. / glass 1	TELAIO "C" l. opaco colore / vetro 2 col. matt lacq. / glass 2	TELAIO "C" essenza / vetro 1 wood / glass 1	TELAIO "C" essenza / vetro 2 wood / glass 2				Maggiorazione per interno laccato opaco  Increase for matt lacquered inside finish
									
									
EL. 3 ANTE da 740 mm EL. 3 DOORS 740 mm									
<b>3.333</b>	<b>2.596</b>	<b>2.587</b>	<b>2.641</b>	<b>2.941</b>	<b>2.995</b>				<b>544</b>
<b>3.474</b>	<b>2.663</b>	<b>2.654</b>	<b>2.708</b>	<b>3.028</b>	<b>3.082</b>				<b>579</b>
EL. 3 ANTE da 1021 mm EL. 3 DOORS 1021 mm									
<b>4.008</b>	<b>2.980</b>	<b>2.977</b>	<b>3.052</b>	<b>3.403</b>	<b>3.478</b>				<b>664</b>
<b>4.149</b>	<b>3.056</b>	<b>3.053</b>	<b>3.128</b>	<b>3.511</b>	<b>3.586</b>				<b>702</b>
EL. 3 ANTE da 1265 mm EL. 3 DOORS 1265 mm									
<b>4.803</b>	<b>3.520</b>	<b>3.520</b>	<b>3.613</b>	<b>4.006</b>	<b>4.099</b>				<b>766</b>
<b>5.034</b>	<b>3.611</b>	<b>3.611</b>	<b>3.704</b>	<b>4.141</b>	<b>4.234</b>				<b>804</b>
EL. 4 ANTE da 1021 mm EL. 4 DOORS 1021 mm									
<b>5.294</b>	<b>3.914</b>	<b>3.910</b>	<b>4.010</b>	<b>4.456</b>	<b>4.556</b>				<b>882</b>
<b>5.538</b>	<b>4.012</b>	<b>4.008</b>	<b>4.108</b>	<b>4.594</b>	<b>4.694</b>				<b>934</b>

Ulteriori combinazioni di aperture e finiture sono possibili utilizzando le scocche vuote a pag. | Additional finishes and opening combinations are possible using the empty bodies on page 168

# SCORREVOLE | SLIDING DOOR

## telaio "D"

VETRI: cat. 1 sabbia chiaro, sabbia scuro, corda, grigio pietra, grigio chiaro, grigio medio, grigio polvere, blu piombo, giallo cromo, verde pompelmo, rosso rubino, nero, stopsol fumé, specchio, specchio bronzo, specchio fumo. cat. 2 bianco, magnolia.

- Fianchi e divisioni a pag. | Side panels and partitions on page 96

- Prezzi calcolati con interno melaminico.

Dotazione interna vano standard: - N. 1 ripiano - N. 2 tubi appendiabiti





- Prices calculated with melamine inside finish.

Standard internal equipment: - 1 shelf - 2 clothes hangers

- Il telaio dell'anta permette la presa senza bisogno di maniglia.

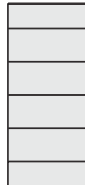
Telaio in alluminio disponibile in finitura bianco, con maggiorazione per la finitura brill spazzolato e laccato opaco colore di 132 euro per modulo (da specificare nell'ordine).

- The door frame allows the opening without the need of a handle. Aluminium frame available in white finish, with increase for the brushed brill finish and colour matt lacquer of 132 euro per module (to be specified in the order).

TELAIO "D" lacc. opaco base basic matt lacq.	TELAIO "D" lacc. opaco colore colour matt lacq.	TELAIO "D" essenza wood	TELAIO "D" rovere lacc. poro aperto open pore lacq. oak	TELAIO "D" lacc. lucido glossy lacq.	TELAIO "D" vetro cat. 1 glass cat. 1
					

Sezione ante | Door section:

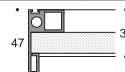

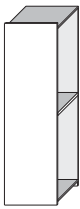
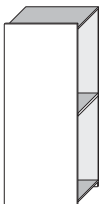
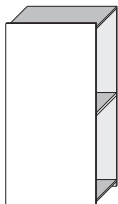
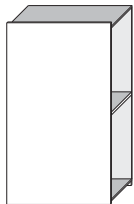





L. 700	H. H.	CODICE CODE	EL. 1 ANTA da 740 mm - escluso di fianchi e divisioni EL. 1 DOOR 740 mm - side panels and partitions not included	745	763	883	947	917	877
 700		2356 EMMS0345							
		2580 EMMS0445		759	777	903	975	945	903
L. 981	H. H.	CODICE CODE	EL. 1 ANTA da 1021 mm - escluso di fianchi e divisioni EL. 1 DOOR 1021 mm - side panels and partitions not included	868	896	1.046	1.130	1.104	1.056
 981		2356 EMMS0355							
		2580 EMMS0455		883	913	1.075	1.165	1.141	1.093
L. 1225	H. H.	CODICE CODE	EL. 1 ANTA da 1265 mm - escluso di fianchi e divisioni EL. 1 DOOR 1265 mm - side panels and partitions not included	1.045	1.081	1.257	1.363	1.337	1.281
 1225		2356 EMMS0365							
		2580 EMMS0465		1.064	1.106	1.292	1.406	1.382	1.328
L. 1425	H. H.	CODICE CODE	EL. 1 ANTA da 1465 mm - escluso di fianchi e divisioni EL. 1 DOOR 1465 mm - side panels and partitions not included	1.134	1.170	1.364	1.490	1.466	1.404
 1425		2356 EMMS0375							
		2580 EMMS0475		1.156	1.192	1.402	1.540	1.516	1.456

Ulteriori combinazioni di aperture e finiture sono possibili utilizzando le scocche vuote a pag. | Additional finishes and opening combinations are possible using the empty bodies on page 168

# SCORREVOLE | SLIDING DOOR

## telaio "D"

**GLASSES: cat. 1** light sand, dark sand, rope, stone grey, light grey, medium grey, powder grey, gun metal blue, chrome yellow, grapefruit green, ruby red, black, smoke-grey stapsol, mirror, bronze mirror, smoke mirror. **cat. 2** white, magnolia.

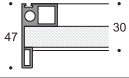
TELAIO "D" vetro cat. 2 glass cat. 2	TELAIO "D" l. opaco colore / essenza colour matt l. / wood	TELAIO "D" l. opaco colore / vetro 1 col. matt lacq. / glass 1	TELAIO "D" l. opaco colore / vetro 2 col. matt lacq. / glass 2	TELAIO "D" essenza / vetro 1 wood / glass 1	TELAIO "D" essenza / vetro 2 wood / glass 2				Maggiorazione per interno laccato opaco  Increase for matt lacquered inside finish
									
									
EL. 1 ANTA da 740 mm - escluso di fianchi e divisioni EL. 1 DOOR 740 mm - side panels and partitions not included									
<b>1.013</b>	<b>823</b>	<b>820</b>	<b>888</b>	<b>880</b>	<b>948</b>				<b>96</b>
<b>1.053</b>	<b>840</b>	<b>840</b>	<b>915</b>	<b>903</b>	<b>978</b>				<b>101</b>
EL. 1 ANTA da 1021 mm - escluso di fianchi e divisioni EL. 1 DOOR 1021 mm - side panels and partitions not included									
<b>1.246</b>	<b>971</b>	<b>976</b>	<b>1.071</b>	<b>1.051</b>	<b>1.146</b>				<b>136</b>
<b>1.303</b>	<b>994</b>	<b>1.003</b>	<b>1.108</b>	<b>1.084</b>	<b>1.189</b>				<b>142</b>
EL. 1 ANTA da 1265 mm - escluso di fianchi e divisioni EL. 1 DOOR 1265 mm - side panels and partitions not included									
<b>1.515</b>	<b>1.169</b>	<b>1.181</b>	<b>1.298</b>	<b>1.269</b>	<b>1.386</b>				<b>170</b>
<b>1.586</b>	<b>1.199</b>	<b>1.217</b>	<b>1.346</b>	<b>1.310</b>	<b>1.439</b>				<b>176</b>
EL. 1 ANTA da 1465 mm - escluso di fianchi e divisioni EL. 1 DOOR 1465 mm - side panels and partitions not included									
<b>1.678</b>	<b>1.267</b>	<b>1.287</b>	<b>1.424</b>	<b>1.384</b>	<b>1.521</b>				<b>189</b>
<b>1.756</b>	<b>1.297</b>	<b>1.324</b>	<b>1.474</b>	<b>1.429</b>	<b>1.579</b>				<b>199</b>

Ulteriori combinazioni di aperture e finiture sono possibili utilizzando le scocche vuote a pag. | Additional finishes and opening combinations are possible using the empty bodies on page 168

# SCORREVOLE | SLIDING DOOR

## telaiο "D"

**VETRI: cat. 1** sabbia chiara, sabbia scura, corda, grigio pietra, grigio chiaro, grigio medio, grigio polvere, blu piombo, giallo cromo, verde pompelmo, rosso rubino, nero, stopsol fumé, specchio, specchio bronzo, specchio fumo. **cat. 2** bianco, magnolia.

- **Attenzione: la finitura dei fianchi segue la finitura dell'anta (ES: anta mista - fianco come pannello superiore / anta vetro - fianco lacc. opaco base).**
- **Attention: the finish of the sides follows the finish of the door (EX. mixed door - side like upper panel / glass door - basic matt lacq. side).**
- **Prezzi calcolati con interno melaminico.**
- **Dotazione interna vano standard: - N. 1 ripiano - N. 2 tubi appendiabiti**
- **Prices calculated with melamine inside finish.**
- **Standard internal equipment: - 1 shelf - 2 clothes hangers**
- **Il telaio dell'anta permette la presa senza bisogno di maniglia.**
- **Telaio in alluminio disponibile in finitura bianco, con maggiorazione per la finitura brill spazzolato e laccato opaco colore di 132 euro per modulo (da specificare nell'ordine).**
- **The door frame allows the opening without the need of a handle.**
- **Alluminium frame available in white finish, with increase for the brushed brill finish and colour matt lacquer of 132 euro per module (to be specified in the order).**

TELAIO "D" lacc. opaco base basic matt lacq.	TELAIO "D" lacc. opaco colore colour matt lacq.	TELAIO "D" essenza wood	TELAIO "D" rovere lacc. poro aperto open pore lacq. oak	TELAIO "D" lacc. lucido glossy lacq.	TELAIO "D" vetro cat. 1 glass cat. 1

Sezione ante | Door section:

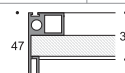







L. 1475	H. H.	CODICE CODE	EL. 2 ANTE da 740 mm EL. 2 DOORS 740 mm								
 				2356	EMAS3130	<b>1.811</b>	<b>1.875</b>	<b>2.184</b>	<b>2.402</b>	<b>2.339</b>	<b>2.075</b>
				2580	EMAS4130	<b>1.859</b>	<b>1.923</b>	<b>2.250</b>	<b>2.493</b>	<b>2.432</b>	<b>2.147</b>
L. 2037	H. H.	CODICE CODE	EL. 2 ANTE da 1021 mm EL. 2 DOORS 1021 mm								
 				2356	EMAS3200	<b>2.057</b>	<b>2.141</b>	<b>2.510</b>	<b>2.768</b>	<b>2.713</b>	<b>2.433</b>
				2580	EMAS4200	<b>2.107</b>	<b>2.195</b>	<b>2.594</b>	<b>2.873</b>	<b>2.824</b>	<b>2.527</b>
L. 2525	H. H.	CODICE CODE	EL. 2 ANTE da 1265 mm EL. 2 DOORS 1265 mm								
 				2356	EMAS3230	<b>2.411</b>	<b>2.511</b>	<b>2.932</b>	<b>3.234</b>	<b>3.179</b>	<b>2.883</b>
				2580	EMAS4230	<b>2.469</b>	<b>2.581</b>	<b>3.028</b>	<b>3.355</b>	<b>3.306</b>	<b>2.997</b>
L. 2925	H. H.	CODICE CODE	EL. 2 ANTE da 1465 mm EL. 2 DOORS 1465 mm								
 				2356	EMAS3280	<b>2.589</b>	<b>2.689</b>	<b>3.146</b>	<b>3.488</b>	<b>3.437</b>	<b>3.129</b>
				2580	EMAS4280	<b>2.653</b>	<b>2.753</b>	<b>3.248</b>	<b>3.623</b>	<b>3.574</b>	<b>3.253</b>

Ulteriori combinazioni di aperture e finiture sono possibili utilizzando le scocche vuote a pag. | Additional finishes and opening combinations are possible using the empty bodies on page 168

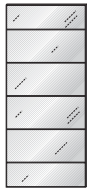
# SCORREVOLE | SLIDING DOOR

## telaio "D"

GLASSES: **cat. 1** light sand, dark sand, rope, stone grey, light grey, medium grey, powder grey, gun metal blue, chrome yellow, grapefruit green, ruby red, black, smoke-grey stapsol, mirror, bronze mirror, smoke mirror. **cat. 2** white, magnolia.

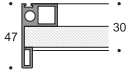
TELAIO "D" vetro cat. 2 glass cat. 2	TELAIO "D" l. opaco colore / essenza colour matt l. / wood	TELAIO "D" l. opaco colore / vetro 1 col. matt lacq. / glass 1	TELAIO "D" l. opaco colore / vetro 2 col. matt lacq. / glass 2	TELAIO "D" essenza / vetro 1 wood / glass 1	TELAIO "D" essenza / vetro 2 wood / glass 2				Maggiorazione per interno laccato opaco  Increase for matt lacquered inside finish
									
									
EL. 2 ANTE da 740 mm EL. 2 DOORS 740 mm									
<b>2.347</b>	<b>1.995</b>	<b>1.989</b>	<b>2.125</b>	<b>2.178</b>	<b>2.314</b>				<b>368</b>
<b>2.447</b>	<b>2.049</b>	<b>2.049</b>	<b>2.199</b>	<b>2.250</b>	<b>2.400</b>				<b>391</b>
EL. 2 ANTE da 1021 mm EL. 2 DOORS 1021 mm									
<b>2.813</b>	<b>2.291</b>	<b>2.301</b>	<b>2.491</b>	<b>2.520</b>	<b>2.710</b>				<b>448</b>
<b>2.947</b>	<b>2.357</b>	<b>2.375</b>	<b>2.585</b>	<b>2.612</b>	<b>2.822</b>				<b>473</b>
EL. 2 ANTE da 1265 mm EL. 2 DOORS 1265 mm									
<b>3.351</b>	<b>2.687</b>	<b>2.711</b>	<b>2.945</b>	<b>2.956</b>	<b>3.190</b>				<b>516</b>
<b>3.513</b>	<b>2.767</b>	<b>2.803</b>	<b>3.061</b>	<b>3.064</b>	<b>3.322</b>				<b>541</b>
EL. 2 ANTE da 1465 mm EL. 2 DOORS 1465 mm									
<b>3.677</b>	<b>2.883</b>	<b>2.923</b>	<b>3.197</b>	<b>3.186</b>	<b>3.460</b>				<b>554</b>
<b>3.853</b>	<b>2.963</b>	<b>3.017</b>	<b>3.317</b>	<b>3.302</b>	<b>3.602</b>				<b>587</b>

Ulteriori combinazioni di aperture e finiture sono possibili utilizzando le scocche vuote a pag. | Additional finishes and opening combinations are possible using the empty bodies on page 168

# SCORREVOLE | SLIDING DOOR

## telaiο "D"

**VETRI: cat. 1** sabbia chiara, sabbia scura, corda, grigio pietra, grigio chiaro, grigio medio, grigio polvere, blu piombo, giallo cromo, verde pompelmo, rosso rubino, nero, stopsol fumé, specchio, specchio bronzo, specchio fumo. **cat. 2** bianco, magnolia.

- **Attenzione: la finitura dei fianchi segue la finitura dell'anta (ES: anta mista - fianco come pannello superiore / anta vetro - fianco lacc. opaco base).**
- **Attention: the finish of the sides follows the finish of the door (EX. mixed door - side like upper panel / glass door - basic matt lacq. side).**
- **Prezzi calcolati con interno melaminico.**  
Dotazione interna vano standard: - N. 1 ripiano - N. 2 tubi appendiabiti
- **Prices calculated with melamine inside finish.**  
Standard internal equipment: - 1 shelf - 2 clothes hangers
- **Il telaio dell'anta permette la presa senza bisogno di maniglia.**  
Telaio in alluminio disponibile in finitura bianco, con maggiorazione per la finitura brill spazzolato e laccato opaco colore di **132 euro per modulo (da specificare nell'ordine).**
- **The door frame allows the opening without the need of a handle.**  
Alluminium frame available in white finish, with increase for the brushed brill finish and colour matt lacquer of **132 euro per modulo (to be specified in the order).**

TELAIO "D" lacc. opaco base basic matt lacq.	TELAIO "D" lacc. opaco colore colour matt lacq.	TELAIO "D" essenza wood	TELAIO "D" rovere lacc. poro aperto open pore lacq. oak	TELAIO "D" lacc. lucido glossy lacq.	TELAIO "D" vetro cat. 1 glass cat. 1

### Sezione ante | Door section:

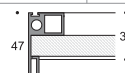







L. 2200	H. H.	CODICE CODE	EL. 3 ANTE da 740 mm EL. 3 DOORS 740 mm						
			2356	EMAS3210	2.637	2.719	3.145	3.425	3.333
		2580	EMAS4210	2.703	2.783	3.235	3.547	3.455	3.135
L. 3043	H. H.	CODICE CODE	EL. 3 ANTE da 1021 mm EL. 3 DOORS 1021 mm						
			2356	EMAS3300	3.006	3.118	3.634	3.974	3.894
		2580	EMAS4300	3.075	3.191	3.751	4.117	4.043	3.705
L. 3775	H. H.	CODICE CODE	EL. 3 ANTE da 1265 mm EL. 3 DOORS 1265 mm						
			2356	EMAS3360	3.537	3.673	4.267	4.673	4.593
		2580	EMAS4360	3.618	3.770	4.402	4.840	4.766	4.410
L. 4049	H. H.	CODICE CODE	EL. 4 ANTE da 1021 mm EL. 4 DOORS 1021 mm						
			2356	EMAS3400	3.958	4.098	4.764	5.188	5.082
		2580	EMAS4400	4.046	4.192	4.914	5.370	5.272	4.886

Ulteriori combinazioni di aperture e finiture sono possibili utilizzando le scocche vuote a pag. | Additional finishes and opening combinations are possible using the empty bodies on page 168

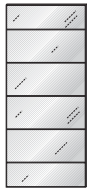
# SCORREVOLE | SLIDING DOOR

## telaiο "D"

GLASSES: **cat. 1** light sand, dark sand, rope, stone grey, light grey, medium grey, powder grey, gun metal blue, chrome yellow, grapefruit green, ruby red, black, smoke-grey stapsol, mirror, bronze mirror, smoke mirror. **cat. 2** white, magnolia.

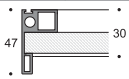
TELAIO "D" vetro cat. 2 glass cat. 2	TELAIO "D" l. opaco colore / essenza colour matt l. / wood	TELAIO "D" l. opaco colore / vetro 1 col. matt lacq. / glass 1	TELAIO "D" l. opaco colore / vetro 2 col. matt lacq. / glass 2	TELAIO "D" essenza / vetro 1 wood / glass 1	TELAIO "D" essenza / vetro 2 wood / glass 2				Maggiorazione per interno laccato opaco  Increase for matt lacquered inside finish
									
									
EL. 3 ANTE da 740 mm EL. 3 DOORS 740 mm									
<b>3.441</b>	<b>2.899</b>	<b>2.890</b>	<b>3.094</b>	<b>3.136</b>	<b>3.340</b>				<b>544</b>
<b>3.585</b>	<b>2.972</b>	<b>2.972</b>	<b>3.197</b>	<b>3.235</b>	<b>3.460</b>				<b>579</b>
EL. 3 ANTE da 1021 mm EL. 3 DOORS 1021 mm									
<b>4.140</b>	<b>3.343</b>	<b>3.358</b>	<b>3.643</b>	<b>3.649</b>	<b>3.934</b>				<b>664</b>
<b>4.335</b>	<b>3.434</b>	<b>3.461</b>	<b>3.776</b>	<b>3.778</b>	<b>4.093</b>				<b>702</b>
EL. 3 ANTE da 1265 mm EL. 3 DOORS 1265 mm									
<b>4.947</b>	<b>3.937</b>	<b>3.973</b>	<b>4.324</b>	<b>4.303</b>	<b>4.654</b>				<b>766</b>
<b>5.184</b>	<b>4.049</b>	<b>4.103</b>	<b>4.490</b>	<b>4.456</b>	<b>4.843</b>				<b>804</b>
EL. 4 ANTE da 1021 mm EL. 4 DOORS 1021 mm									
<b>5.470</b>	<b>4.398</b>	<b>4.418</b>	<b>4.798</b>	<b>4.784</b>	<b>5.164</b>				<b>882</b>
<b>5.726</b>	<b>4.516</b>	<b>4.552</b>	<b>4.972</b>	<b>4.950</b>	<b>5.370</b>				<b>934</b>

Ulteriori combinazioni di aperture e finiture sono possibili utilizzando le scocche vuote a pag. | Additional finishes and opening combinations are possible using the empty bodies on page 168

# SCORREVOLE | SLIDING DOOR

composta

- Fianchi e divisioni a pag. | *Side panels and partitions on page 96*

- Prezzi calcolati con interno melaminico.

Dotazione interna vano standard: - N. 1 ripiano - N. 2 tubi appendiabiti





- *Prices calculated with melamine inside finish.*

Standard internal equipment: - 1 shelf - 2 clothes hangers

- Maniglie a pag. | *Handles on page 89*

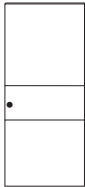
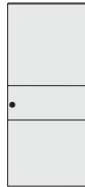



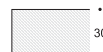

- Il pannello centrale inoltre è disponibile anche con incisioni (motivo ad onda) su pannello rovere laccato poro aperto.

- *The middle panel is also available with engravings (wave design) on open pore lacq. oak.*

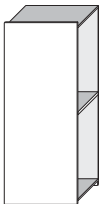
COMPOSTA lacc. opaco base <i>basic matt lacq.</i>	COMPOSTA lacc. opaco colore <i>colour matt lacq.</i>	COMPOSTA essenza <i>wood</i>	COMPOSTA rovere lacc. poro aperto <i>open pore lacq. oak</i>	COMPOSTA rovere termotrattato <i>heat-treated oak</i>	COMPOSTA lacc. lucido <i>glossy lacq.</i>
					

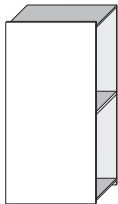
Sezione ante | *Door section:*

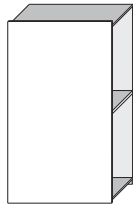







L. 981		H. H.	CODICE CODE	EL. 1 ANTA da 1021 mm - escluso di fianchi e divisioni <i>EL. 1 DOOR 1021 mm - side panels and partitions not included</i>							
				2356	EMMS0355	882	916	965	1.088	1.070	1.080
				2580	EMMS0455	901	938	990	1.127	1.107	1.118
L. 1225		H. H.	CODICE CODE	EL. 1 ANTA da 1265 mm - escluso di fianchi e divisioni <i>EL. 1 DOOR 1265 mm - side panels and partitions not included</i>							
				2356	EMMS0365	1.059	1.102	1.153	1.311	1.287	1.305
				2580	EMMS0465	1.084	1.132	1.185	1.362	1.335	1.354
L. 1425		H. H.	CODICE CODE	EL. 1 ANTA da 1465 mm - escluso di fianchi e divisioni <i>EL. 1 DOOR 1465 mm - side panels and partitions not included</i>							
				2356	EMMS0375	1.156	1.205	1.253	1.441	1.414	1.441
				2580	EMMS0475	1.183	1.238	1.289	1.497	1.468	1.495

Ulteriori combinazioni di aperture e finiture sono possibili utilizzando le scocche vuote a pag. | *Additional finishes and opening combinations are possible using the empty bodies on page 168*

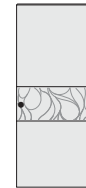

# SCORREVOLE | SLIDING DOOR

## composta

COMPOSTA l. opaco colore / essenza <i>colour matt l. / wood</i>	COMPOSTA l. opaco / rovere termotr. <i>matt l. / heat-treated oak</i>	COMPOSTA lacc. lucido / essenza <i>glossy lacq. / wood</i>	COMPOSTA l. lucido / rovere termotr. <i>glossy l. / heat-treated oak</i>	COMPOSTA l. o. colore / rovere p. a. <i>col. matt lacq. / oak o. p.</i>	COMPOSTA l. opaco colore / onda <i>col. matt lacq. / wave</i>	COMPOSTA rovere poro aperto / onda <i>open pore oak l. / wave</i>			Maggiorazione per interno laccato opaco  <i>Increase for matt lacquered inside finish</i>
									
									
EL. 1 ANTA da 1021 mm - escluso di fianchi e divisioni <i>EL. 1 DOOR 1021 mm - side panels and partitions not included</i>									
<b>925</b>	<b>946</b>	<b>1.059</b>	<b>1.080</b>	<b>949</b>	<b>984</b>	<b>1.123</b>			<b>136</b>
<b>947</b>	<b>968</b>	<b>1.097</b>	<b>1.118</b>	<b>971</b>	<b>1.006</b>	<b>1.162</b>			<b>142</b>
EL. 1 ANTA da 1265 mm - escluso di fianchi e divisioni <i>EL. 1 DOOR 1265 mm - side panels and partitions not included</i>									
<b>1.111</b>	<b>1.136</b>	<b>1.277</b>	<b>1.302</b>	<b>1.142</b>	<b>1.178</b>	<b>1.347</b>			<b>170</b>
<b>1.141</b>	<b>1.166</b>	<b>1.326</b>	<b>1.351</b>	<b>1.172</b>	<b>1.208</b>	<b>1.398</b>			<b>176</b>
EL. 1 ANTA da 1465 mm - escluso di fianchi e divisioni <i>EL. 1 DOOR 1465 mm - side panels and partitions not included</i>									
<b>1.214</b>	<b>1.244</b>	<b>1.406</b>	<b>1.436</b>	<b>1.250</b>	<b>1.287</b>	<b>1.478</b>			<b>189</b>
<b>1.247</b>	<b>1.277</b>	<b>1.460</b>	<b>1.490</b>	<b>1.283</b>	<b>1.320</b>	<b>1.534</b>			<b>199</b>

Ulteriori combinazioni di aperture e finiture sono possibili utilizzando le scocche vuote a pag. | *Additional finishes and opening combinations are possible using the empty bodies on page 168*

# SCORREVOLE | SLIDING DOOR

composta

- **Attenzione: la finitura dei fianchi segue la finitura dell'anta (ES: anta - essenza - fianco essenza / anta mista - fianco come pannelli grandi).**  
 - *Attention: the finish of the sides follows the finish of the door (EX. wooden door - wooden side / mixed door - side like big panels).*

- **Prezzi calcolati con interno melaminico.**  
**Dotazione interna vano standard: - N. 1 ripiano - N. 2 tubi appendiabiti**  
 - *Prices calculated with melamine inside finish.*  
**Standard internal equipment: - 1 shelf - 2 clothes hangers**

- **Maniglie a pag. | Handles on page 89**

- **Il pannello centrale inoltre è disponibile anche con incisioni (motivo ad onda) su pannello rovere laccato poro aperto.**  
 - *The middle panel is also available with engravings (wave design) on open pore lacq. oak.*

**COMPOSTA**  
lacc. opaco base  
*basic matt lacq.*

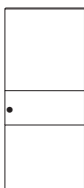

**COMPOSTA**  
lacc. opaco colore  
*colour matt lacq.*

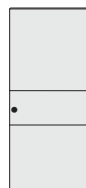

**COMPOSTA**  
essenza  
*wood*



**COMPOSTA**  
rovere lacc. poro aperto  
*open pore lacq. oak*



**COMPOSTA**  
rovere termotrattato  
*heat-treated oak*



**COMPOSTA**  
lacc. lucido  
*glossy lacq.*



**Sezione ante | Door section:**

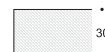

L. 2037	H. H.	CODICE CODE	EL. 2 ANTE da 1021 mm EL. 2 DOORS 1021 mm																		
			2356	EMAS3200	2.085	2.181	2.348	2.684	2.632	2.665											
			2580	EMAS4200	2.143	2.245	2.424	2.797	2.737	2.778											
L. 2525	H. H.	CODICE CODE	EL. 2 ANTE da 1265 mm EL. 2 DOORS 1265 mm																		
			2356	EMAS3230	2.439	2.553	2.724	3.130	3.066	3.115											
			2580	EMAS4230	2.509	2.633	2.814	3.267	3.193	3.250											
L. 2925	H. H.	CODICE CODE	EL. 2 ANTE da 1465 mm EL. 2 DOORS 1465 mm																		
			2356	EMAS3280	2.633	2.759	2.924	3.390	3.320	3.387											
			2580	EMAS4280	2.707	2.845	3.022	3.537	3.459	3.532											
<table border="1" style="width: 100%; height: 100px;"> <tr> <td> </td><td> </td><td> </td><td> </td><td> </td><td> </td><td> </td><td> </td><td> </td><td> </td><td> </td> </tr> </table>																					

Ulteriori combinazioni di aperture e finiture sono possibili utilizzando le scocche vuote a pag. | Additional finishes and opening combinations are possible using the empty bodies on page 168

# SCORREVOLE | SLIDING DOOR

## composta

COMPOSTA l. opaco colore / essenza <i>colour matt l. / wood</i>		COMPOSTA l. opaco / rovere termotr. <i>matt l. / heat-treated oak</i>		COMPOSTA lacc. lucido / essenza <i>glossy lacq. / wood</i>		COMPOSTA l. lucido / rovere termotr. <i>glossy l. / heat-treated oak</i>		COMPOSTA l. o. colore / rovere p. a. <i>col. matt lacq. / o. p. oak</i>		COMPOSTA l. opaco colore / onda <i>col. matt lacq. / wave</i>		COMPOSTA rovere poro aperto / onda <i>open pore oak l. / wave</i>		Maggiorazione per interno laccato opaco  <i>Increase for matt lacquered inside finish</i>
														
EL. 2 ANTE da 1021 mm <i>EL. 2 DOORS 1021 mm</i>														
<b>2.199</b>	<b>2.241</b>	<b>2.623</b>	<b>2.665</b>	<b>2.247</b>	<b>2.317</b>	<b>2.754</b>							<b>448</b>	
<b>2.263</b>	<b>2.305</b>	<b>2.736</b>	<b>2.778</b>	<b>2.311</b>	<b>2.381</b>	<b>2.867</b>							<b>473</b>	
EL. 2 ANTE da 1265 mm <i>EL. 2 DOORS 1265 mm</i>														
<b>2.571</b>	<b>2.621</b>	<b>3.059</b>	<b>3.109</b>	<b>2.633</b>	<b>2.705</b>	<b>3.202</b>							<b>516</b>	
<b>2.651</b>	<b>2.701</b>	<b>3.194</b>	<b>3.244</b>	<b>2.713</b>	<b>2.785</b>	<b>3.339</b>							<b>541</b>	
EL. 2 ANTE da 1465 mm <i>EL. 2 DOORS 1465 mm</i>														
<b>2.777</b>	<b>2.837</b>	<b>3.317</b>	<b>3.377</b>	<b>2.849</b>	<b>2.923</b>	<b>3.464</b>							<b>554</b>	
<b>2.863</b>	<b>2.923</b>	<b>3.462</b>	<b>3.522</b>	<b>2.935</b>	<b>3.009</b>	<b>3.611</b>							<b>587</b>	

Ulteriori combinazioni di aperture e finiture sono possibili utilizzando le scocche vuote a pag. | *Additional finishes and opening combinations are possible using the empty bodies on page 168*

# SCORREVOLE | SLIDING DOOR

composta

- **Attenzione: la finitura dei fianchi segue la finitura dell'anta (ES: anta - essenza - fianco essenza / anta mista - fianco come pannelli grandi).**  
 - *Attention: the finish of the sides follows the finish of the door (EX. wooden door - wooden side / mixed door - side like big panels).*

- **Prezzi calcolati con interno melaminico.**  
**Dotazione interna vano standard: - N. 1 ripiano - N. 2 tubi appendiabiti**  
 - *Prices calculated with melamine inside finish.*  
**Standard internal equipment: - 1 shelf - 2 clothes hangers**

- **Maniglie a pag. | Handles on page 89**

- **Il pannello centrale inoltre è disponibile anche con incisioni (motivo ad onda) su pannello rovere laccato poro aperto.**  
 - *The middle panel is also available with engravings (wave design) on open pore lacq. oak.*

**COMPOSTA**  
lacc. opaco base  
*basic matt lacq.*

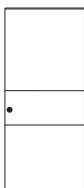

**COMPOSTA**  
lacc. opaco colore  
*colour matt lacq.*

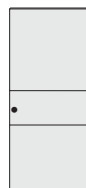

**COMPOSTA**  
essenza  
*wood*



**COMPOSTA**  
rovere lacc. poro aperto  
*open pore lacq. oak*



**COMPOSTA**  
rovere termotrattato  
*heat-treated oak*



**COMPOSTA**  
lacc. lucido  
*glossy lacq.*



**Sezione ante | Door section:**

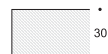

**L. 3043**

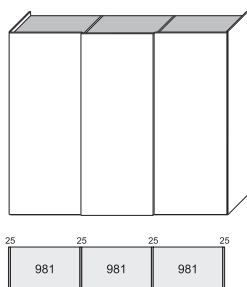

H.  
H.

CODICE  
CODE

EL. 3 ANTE da 1021 mm  
EL. 3 DOORS 1021 mm

2356	EMAS3300	<b>3.048</b>	<b>3.178</b>	<b>3.391</b>	<b>3.848</b>	<b>3.782</b>	<b>3.822</b>
2580	EMAS4300	<b>3.129</b>	<b>3.266</b>	<b>3.496</b>	<b>4.003</b>	<b>3.925</b>	<b>3.974</b>

**L. 3775**

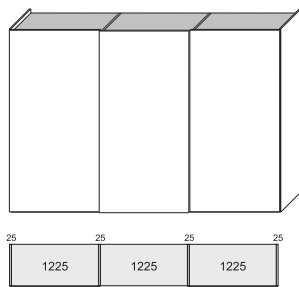

H.  
H.

CODICE  
CODE

EL. 3 ANTE da 1265 mm  
EL. 3 DOORS 1265 mm

2356	EMAS3360	<b>3.579</b>	<b>3.736</b>	<b>3.955</b>	<b>4.517</b>	<b>4.433</b>	<b>4.497</b>
2580	EMAS4360	<b>3.678</b>	<b>3.848</b>	<b>4.081</b>	<b>4.708</b>	<b>4.609</b>	<b>4.682</b>

**L. 4049**

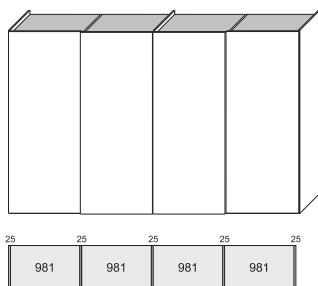

H.  
H.

CODICE  
CODE







EL. 4 ANTE da 1021 mm  
EL. 4 DOORS 1021 mm

2356	EMAS3400	<b>4.014</b>	<b>4.178</b>	<b>4.440</b>	<b>5.020</b>	<b>4.936</b>	<b>4.986</b>
2580	EMAS4400	<b>4.118</b>	<b>4.292</b>	<b>4.574</b>	<b>5.218</b>	<b>5.120</b>	<b>5.180</b>

Ulteriori combinazioni di aperture e finiture sono possibili utilizzando le scocche vuote a pag. | Additional finishes and opening combinations are possible using the empty bodies on page 168

# SCORREVOLE | SLIDING DOOR

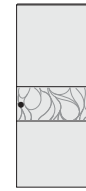
## composta





COMPOSTA l. opaco colore / essenza colour matt l. / wood	COMPOSTA l. opaco / rovere termotr. matt l. / heat-treated oak	COMPOSTA lacc. lucido / essenza glossy lacq. / wood	COMPOSTA l. lucido / rovere termotr. glossy l. / heat-treated oak	COMPOSTA l. o. colore / rovere p. a. col. matt lacq. / o. p. oak	COMPOSTA l. opaco colore / onda col. matt lacq. / wave	COMPOSTA rovere poro aperto / onda open pore oak l. / wave			Maggiorazione per interno laccato opaco  Increase for matt lacquered inside finish
									
									
EL. 3 ANTE da 1021 mm EL. 3 DOORS 1021 mm									
<b>3.205</b>	<b>3.268</b>	<b>3.759</b>	<b>3.822</b>	<b>3.277</b>	<b>3.382</b>	<b>3.953</b>			<b>664</b>
<b>3.293</b>	<b>3.356</b>	<b>3.911</b>	<b>3.974</b>	<b>3.365</b>	<b>3.470</b>	<b>4.108</b>			<b>702</b>
EL. 3 ANTE da 1265 mm EL. 3 DOORS 1265 mm									
<b>3.763</b>	<b>3.838</b>	<b>4.413</b>	<b>4.488</b>	<b>3.856</b>	<b>3.964</b>	<b>4.625</b>			<b>766</b>
<b>3.875</b>	<b>3.950</b>	<b>4.598</b>	<b>4.673</b>	<b>3.968</b>	<b>4.076</b>	<b>4.816</b>			<b>804</b>
EL. 4 ANTE da 1021 mm EL. 4 DOORS 1021 mm									
<b>4.214</b>	<b>4.298</b>	<b>4.902</b>	<b>4.986</b>	<b>4.310</b>	<b>4.450</b>	<b>5.160</b>			<b>882</b>
<b>4.328</b>	<b>4.412</b>	<b>5.096</b>	<b>5.180</b>	<b>4.424</b>	<b>4.564</b>	<b>5.358</b>			<b>934</b>

Ulteriori combinazioni di aperture e finiture sono possibili utilizzando le scocche vuote a pag. | Additional finishes and opening combinations are possible using the empty bodies on page 168

# SCORREVOLE | SLIDING DOOR

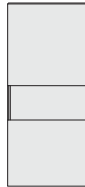



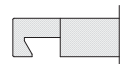

## composta plus

- Fianchi e divisioni a pag. | *Side panels and partitions on page 96*
- Prezzi calcolati con interno melaminico.
- Dotazione interna vano standard: - N. 1 ripiano - N. 2 tubi appendiabiti
- *Prices calculated with melamine inside finish.*
- *Standard internal equipment: - 1 shelf - 2 clothes hangers*
- Il pannello centrale inoltre è disponibile anche con incisioni (motivo ad onda) su pannello rovere laccato poro aperto.
- *The middle panel is also available with engravings (wave design) on open pore lacq. oak.*
- Nell'anta COMPOSTA PLUS la maniglia è inserita su pannello centrale. Disponibile nelle finiture laccato opaco o lucido, rovere lacc. poro aperto, rovere moro, rovere tabacco, rovere nodi o rovere termotrattato.
- *The door COMPOSTA PLUS is supplied with a handle built-in the central panel. Available in matt or glossy lacquer, open-pore lacquered oak, oak in mahogany or tobacco finish, oak knots or heat-treated oak.*

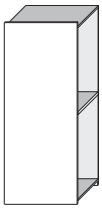
COMPOSTA PLUS lacc. opaco base <i>basic matt lacq.</i>	COMPOSTA PLUS lacc. opaco colore <i>colour matt lacq.</i>	COMPOSTA PLUS essenza <i>wood</i>	COMPOSTA PLUS rovere lacc. poro aperto <i>open pore lacq. oak</i>	COMPOSTA PLUS rovere termotrattato <i>heat-treated oak</i>	COMPOSTA PLUS lacc. lucido <i>glossy lacq.</i>
					

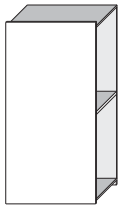
Sezione ante | *Door section:*

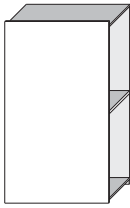







L. 981		H. H.	CODICE CODE	EL. 1 ANTA da 1021 mm - escluso di fianchi e divisioni <i>EL. 1 DOOR 1021 mm - side panels and partitions not included</i>							
				2356	EMMS0355	952	986	1.035	1.158	1.140	1.150
				2580	EMMS0455	971	1.008	1.060	1.197	1.177	1.188
L. 1225		H. H.	CODICE CODE	EL. 1 ANTA da 1265 mm - escluso di fianchi e divisioni <i>EL. 1 DOOR 1265 mm - side panels and partitions not included</i>							
				2356	EMMS0365	1.129	1.172	1.223	1.381	1.357	1.375
				2580	EMMS0465	1.154	1.202	1.255	1.432	1.405	1.424
L. 1425		H. H.	CODICE CODE	EL. 1 ANTA da 1465 mm - escluso di fianchi e divisioni <i>EL. 1 DOOR 1465 mm - side panels and partitions not included</i>							
				2356	EMMS0375	1.226	1.275	1.323	1.511	1.484	1.511
				2580	EMMS0475	1.253	1.308	1.359	1.567	1.538	1.565

Ulteriori combinazioni di aperture e finiture sono possibili utilizzando le scocche vuote a pag. | *Additional finishes and opening combinations are possible using the empty bodies on page 168*

# SCORREVOLE | SLIDING DOOR

## composta plus

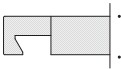
COMPOSTA PLUS l. opaco colore / essenza <i>colour matt l. / wood</i>	COMPOSTA PLUS l. opaco / rovere termotr. <i>matt l. / heat-treated oak</i>	COMPOSTA PLUS lacc. lucido / essenza <i>glossy lacq. / wood</i>	COMPOSTA PLUS l. lucido / rovere termotr. <i>glossy l. / heat-treated oak</i>	COMPOSTA PLUS l. o. colore / rovere p. a. <i>col. matt lacq. / o. p. oak</i>	COMPOSTA PLUS l. opaco colore / onda <i>col. matt lacq. / wave</i>	COMPOSTA PLUS rovere poro aperto / onda <i>open pore oak l. / wave</i>			Maggiorazione per interno laccato opaco  <i>Increase for matt lacquered inside finish</i>
									
									
EL. 1 ANTA da 1021 mm - escluso di fianchi e divisioni <i>EL. 1 DOOR 1021 mm - side panels and partitions not included</i>									
<b>995</b>	<b>1.016</b>	<b>1.129</b>	<b>1.150</b>	<b>1.019</b>	<b>1.054</b>	<b>1.193</b>			<b>136</b>
<b>1.017</b>	<b>1.038</b>	<b>1.167</b>	<b>1.188</b>	<b>1.041</b>	<b>1.076</b>	<b>1.232</b>			<b>142</b>
EL. 1 ANTA da 1265 mm - escluso di fianchi e divisioni <i>EL. 1 DOOR 1265 mm - side panels and partitions not included</i>									
<b>1.181</b>	<b>1.206</b>	<b>1.347</b>	<b>1.372</b>	<b>1.212</b>	<b>1.248</b>	<b>1.417</b>			<b>170</b>
<b>1.211</b>	<b>1.236</b>	<b>1.396</b>	<b>1.421</b>	<b>1.242</b>	<b>1.278</b>	<b>1.468</b>			<b>176</b>
EL. 1 ANTA da 1465 mm - escluso di fianchi e divisioni <i>EL. 1 DOOR 1465 mm - side panels and partitions not included</i>									
<b>1.284</b>	<b>1.314</b>	<b>1.476</b>	<b>1.506</b>	<b>1.320</b>	<b>1.357</b>	<b>1.548</b>			<b>189</b>
<b>1.317</b>	<b>1.347</b>	<b>1.530</b>	<b>1.560</b>	<b>1.353</b>	<b>1.390</b>	<b>1.604</b>			<b>199</b>

Ulteriori combinazioni di aperture e finiture sono possibili utilizzando le scocche vuote a pag. | *Additional finishes and opening combinations are possible using the empty bodies on page 168*

# SCORREVOLE | SLIDING DOOR

## composta plus

- **Attenzione: la finitura dei fianchi segue la finitura dell'anta (ES: anta - essenza - fianco essenza / anta mista - fianco come pannelli grandi).**  
- Attention: the finish of the sides follows the finish of the door (EX. wooden door - wooden side / mixed door - side like big panels).
- **Prezzi calcolati con interno melaminico.**  
- Prices calculated with melamine inside finish.
- **Dotazione interna vano standard: - N. 1 ripiano - N. 2 tubi appendiabiti**  
- Standard internal equipment: - 1 shelf - 2 clothes hangers
- **Il pannello centrale inoltre è disponibile anche con incisioni (motivo ad onda) su pannello rovere laccato poro aperto.**  
- The middle panel is also available with engravings (wave design) on open pore lacq. oak.
- **Nell'anta COMPOSTA PLUS la maniglia è inserita su pannello centrale.**  
- The door COMPOSTA PLUS is supplied with a handle built-in the central panel. Disponibile nelle finiture laccato opaco o lucido, rovere lacc. poro aperto, rovere moro, rovere tabacco, rovere nodi o rovere termotrattato.
- The door COMPOSTA PLUS is supplied with a handle built-in the central panel. Available in matt or glossy lacquer, open-pore lacquered oak, oak in mahogany or tobacco finish, oak knots or heat-treated oak.

COMPOSTA PLUS  
lacc. opaco base  
basic matt lacq.



COMPOSTA PLUS  
lacc. opaco colore  
colour matt lacq.

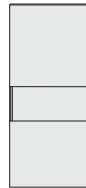

COMPOSTA PLUS  
essenza  
wood



COMPOSTA PLUS  
rovere lacc. poro aperto  
open pore lacq. oak



COMPOSTA PLUS  
rovere termotrattato  
heat-treated oak



COMPOSTA PLUS  
lacc. lucido  
glossy lacq.



Sezione ante | Door section:

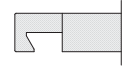

L. 2037

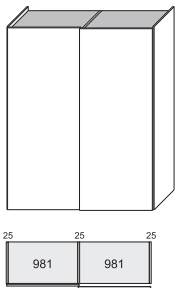

H.  
H. CODICE  
H. CODE

EL. 2 ANTE da 1021 mm  
EL. 2 DOORS 1021 mm

2356 EMAS3200

**2.225**

**2.321**

**2.488**

**2.824**

**2.772**

**2.805**

2580 EMAS4200

**2.283**

**2.385**

**2.564**

**2.937**

**2.877**

**2.918**

L. 2525

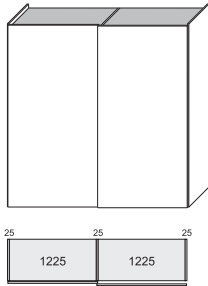

H.  
H. CODICE  
H. CODE

EL. 2 ANTE da 1265 mm  
EL. 2 DOORS 1265 mm

2356 EMAS3230

**2.579**

**2.693**

**2.864**

**3.270**

**3.206**

**3.255**

2580 EMAS4230

**2.649**

**2.773**

**2.954**

**3.407**

**3.333**

**3.390**

L. 2925

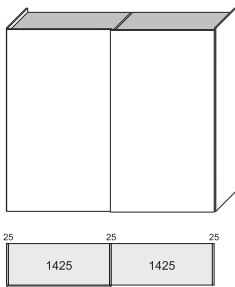

H.  
H. CODICE  
H. CODE

EL. 2 ANTE da 1465 mm  
EL. 2 DOORS 1465 mm

2356 EMAS3280

**2.773**

**2.899**

**3.064**

**3.530**

**3.460**

**3.527**

2580 EMAS4280

**2.847**

**2.985**

**3.162**

**3.677**

**3.599**







**3.672**

Ulteriori combinazioni di aperture e finiture sono possibili utilizzando le scocche vuote a pag. | Additional finishes and opening combinations are possible using the empty bodies on page 168



# SCORREVOLE | SLIDING DOOR

## composta plus

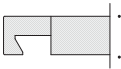



COMPOSTA PLUS l. opaco colore / essenza <i>colour matt l. / wood</i>	COMPOSTA PLUS l. opaco / rovere termotr. <i>matt l. / heat-treated oak</i>	COMPOSTA PLUS lacc. lucido / essenza <i>glossy lacq. / wood</i>	COMPOSTA PLUS l. lucido / rovere termotr. <i>glossy l. / heat-treated oak</i>	COMPOSTA PLUS l. o. colore / rovere p. a. <i>col. matt lacq. / o. p. oak</i>	COMPOSTA PLUS l. opaco colore / onda <i>col. matt lacq. / wave</i>	COMPOSTA PLUS rovere poro aperto / onda <i>open pore oak l. / wave</i>			Maggiorazione per interno laccato opaco  <i>Increase for matt lacquered inside finish</i>
									
									
EL. 2 ANTE da 1021 mm <i>EL. 2 DOORS 1021 mm</i>									
<b>2.339</b>	<b>2.381</b>	<b>2.763</b>	<b>2.805</b>	<b>2.387</b>	<b>2.457</b>	<b>2.894</b>			<b>449</b>
<b>2.403</b>	<b>2.445</b>	<b>2.876</b>	<b>2.918</b>	<b>2.451</b>	<b>2.521</b>	<b>3.007</b>			<b>473</b>
EL. 2 ANTE da 1265 mm <i>EL. 2 DOORS 1265 mm</i>									
<b>2.711</b>	<b>2.761</b>	<b>3.199</b>	<b>3.249</b>	<b>2.773</b>	<b>2.845</b>	<b>3.342</b>			<b>516</b>
<b>2.791</b>	<b>2.841</b>	<b>3.334</b>	<b>3.384</b>	<b>2.853</b>	<b>2.925</b>	<b>3.479</b>			<b>541</b>
EL. 2 ANTE da 1465 mm <i>EL. 2 DOORS 1465 mm</i>									
<b>2.917</b>	<b>2.977</b>	<b>3.457</b>	<b>3.517</b>	<b>2.989</b>	<b>3.063</b>	<b>3.604</b>			<b>554</b>
<b>3.003</b>	<b>3.063</b>	<b>3.602</b>	<b>3.662</b>	<b>3.075</b>	<b>3.149</b>	<b>3.751</b>			<b>587</b>

Ulteriori combinazioni di aperture e finiture sono possibili utilizzando le scocche vuote a pag. | *Additional finishes and opening combinations are possible using the empty bodies on page 168*

# SCORREVOLE | SLIDING DOOR

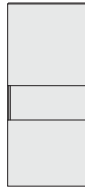
## composta plus

- **Attenzione: la finitura dei fianchi segue la finitura dell'anta (ES: anta - essenza - fianco essenza / anta mista - fianco come pannelli grandi).**
- *Attention: the finish of the sides follows the finish of the door (EX. wooden door - wooden side / mixed door - side like big panels).*
- **Prezzi calcolati con interno melaminico.**
- *Prices calculated with melamine inside finish.*
- **Dotazione interna vano standard: - N. 1 ripiano - N. 2 tubi appendiabiti**
- *Standard internal equipment: - 1 shelf - 2 clothes hangers*
- **Il pannello centrale inoltre è disponibile anche con incisioni (motivo ad onda) su pannello rovere laccato poro aperto.**
- *The middle panel is also available with engravings (wave design) on open pore lacq. oak.*
- **Nell'anta COMPOSTA PLUS la maniglia è inserita su pannello centrale.**
- *The door COMPOSTA PLUS is supplied with a handle built-in the central panel. Available in matt or glossy lacquer, open-pore lacquered oak, oak in mahogany or tobacco finish, oak knots or heat-treated oak.*

<b>COMPOSTA PLUS</b> lacc. opaco base <i>basic matt lacq.</i>	<b>COMPOSTA PLUS</b> lacc. opaco colore <i>colour matt lacq.</i>	<b>COMPOSTA PLUS</b> essenza <i>wood</i>	<b>COMPOSTA PLUS</b> rovere lacc. poro aperto <i>open pore lacq. oak</i>	<b>COMPOSTA PLUS</b> rovere termotrattato <i>heat-treated oak</i>	<b>COMPOSTA PLUS</b> lacc. lucido <i>glossy lacq.</i>
					

Sezione ante | Door section:

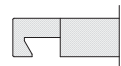

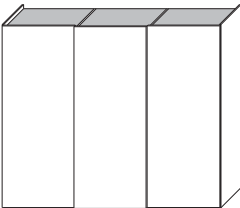
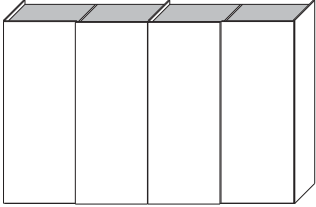





L. 3043		H. H.	CODICE CODE	EL. 3 ANTE da 1021 mm EL. 3 DOORS 1021 mm								
												
2356	EMAS3300			<b>3.258</b>	<b>3.388</b>	<b>3.601</b>	<b>4.058</b>	<b>3.992</b>	<b>4.032</b>			
2580	EMAS4300			<b>3.339</b>	<b>3.476</b>	<b>3.706</b>	<b>4.213</b>	<b>4.135</b>	<b>4.184</b>			
L. 3775		H. H.	CODICE CODE	EL. 3 ANTE da 1265 mm EL. 3 DOORS 1265 mm								
												
2356	EMAS3360			<b>3.789</b>	<b>3.946</b>	<b>4.165</b>	<b>4.727</b>	<b>4.643</b>	<b>4.707</b>			
2580	EMAS4360			<b>3.888</b>	<b>4.058</b>	<b>4.291</b>	<b>4.918</b>	<b>4.819</b>	<b>4.892</b>			
L. 4049		H. H.	CODICE CODE	EL. 4 ANTE da 1021 mm EL. 4 DOORS 1021 mm								
												
2356	EMAS3400			<b>4.294</b>	<b>4.458</b>	<b>4.720</b>	<b>5.300</b>	<b>5.216</b>	<b>5.266</b>			
2580	EMAS4400			<b>4.398</b>	<b>4.572</b>	<b>4.854</b>	<b>5.498</b>	<b>5.400</b>	<b>5.460</b>			

Ulteriori combinazioni di aperture e finiture sono possibili utilizzando le scocche vuote a pag. | Additional finishes and opening combinations are possible using the empty bodies on page 168

# SCORREVOLE | SLIDING DOOR

## composta plus

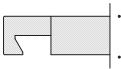
COMPOSTA PLUS l. opaco colore / essenza <i>colour matt l. / wood</i>	COMPOSTA PLUS l. opaco / rovere termotr. <i>matt l. / heat-treated oak</i>	COMPOSTA PLUS lacc. lucido / essenza <i>glossy lacq. / wood</i>	COMPOSTA PLUS l. lucido / rovere termotr. <i>glossy l. / heat-treated oak</i>	COMPOSTA PLUS l. o. colore / rovere p. a. <i>col. matt lacq. / o. p. oak</i>	COMPOSTA PLUS l. opaco colore / onda <i>col. matt lacq. / wave</i>	COMPOSTA PLUS rovere poro aperto / onda <i>open pore oak l. / wave</i>			Maggiorazione per interno laccato opaco  <i>Increase for matt lacquered inside finish</i>
									
									
EL. 3 ANTE da 1021 mm <i>EL. 3 DOORS 1021 mm</i>									
<b>3.415</b>	<b>3.478</b>	<b>3.969</b>	<b>4.032</b>	<b>3.487</b>	<b>3.592</b>	<b>4.163</b>			<b>664</b>
<b>3.503</b>	<b>3.566</b>	<b>4.121</b>	<b>4.184</b>	<b>3.575</b>	<b>3.680</b>	<b>4.318</b>			<b>702</b>
EL. 3 ANTE da 1265 mm <i>EL. 3 DOORS 1265 mm</i>									
<b>3.973</b>	<b>4.048</b>	<b>4.623</b>	<b>4.698</b>	<b>4.066</b>	<b>4.174</b>	<b>4.835</b>			<b>766</b>
<b>4.085</b>	<b>4.160</b>	<b>4.808</b>	<b>4.883</b>	<b>4.178</b>	<b>4.286</b>	<b>5.026</b>			<b>804</b>
EL. 4 ANTE da 1021 mm <i>EL. 4 DOORS 1021 mm</i>									
<b>4.494</b>	<b>4.578</b>	<b>5.182</b>	<b>5.266</b>	<b>4.590</b>	<b>4.730</b>	<b>5.440</b>			<b>882</b>
<b>4.608</b>	<b>4.692</b>	<b>5.376</b>	<b>5.460</b>	<b>4.704</b>	<b>4.844</b>	<b>5.638</b>			<b>934</b>

Ulteriori combinazioni di aperture e finiture sono possibili utilizzando le scocche vuote a pag. | *Additional finishes and opening combinations are possible using the empty bodies on page 168*

# SCORREVOLE | SLIDING DOOR

green

- Fianchi e divisioni a pag. | *Side panels and partitions on page 96*

- Prezzi calcolati con interno melaminico.

- Dotazione interna vano standard: - N. 1 ripiano - N. 2 tubi appendiabiti





- Prices calculated with melamine inside finish.

- Standard internal equipment: - 1 shelf - 2 clothes hangers

- Nell'anta GREEN la maniglia è inserita su pannello inferiore.

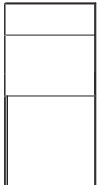
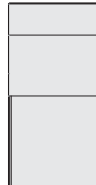
Disponibile nelle finiture laccato opaco o lucido, rovere nodi o rovere termotrattato, rovere laccato poro aperto.

- The door GREEN is supplied with a handle built-in the lower panel.  
Available in matt or glossy lacquer, oak knots or heat-treated oak finish, lacq. open pore oak.

GREEN lacc. opaco base <i>basic matt lacq.</i>	GREEN lacc. opaco colore <i>colour matt lacq.</i>	GREEN lacc. lucido <i>glossy lacq.</i>	GREEN essenza <i>wood</i>	GREEN rovere lacc. poro aperto <i>open pore lacq. oak</i>	GREEN rovere termotrattato <i>heat-treated oak</i>
					

Sezione ante | *Door section:*

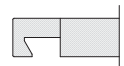

L. 981

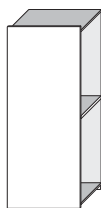

H.  
H.

CODICE  
CODE

EL. 1 ANTA da 1021 mm - escluso di fianchi e divisioni  
*EL. 1 DOOR 1021 mm - side panels and partitions not included*

2356	EMMS0355	<b>968</b>	<b>1.002</b>	<b>1.166</b>	<b>1.051</b>	<b>1.174</b>	<b>1.156</b>
2580	EMMS0455	<b>987</b>	<b>1.024</b>	<b>1.204</b>	<b>1.076</b>	<b>1.213</b>	<b>1.193</b>

L. 1225

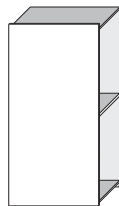

H.  
H.

CODICE  
CODE

EL. 1 ANTA da 1265 mm - escluso di fianchi e divisioni  
*EL. 1 DOOR 1265 mm - side panels and partitions not included*

2356	EMMS0365	<b>1.145</b>	<b>1.188</b>	<b>1.391</b>	<b>1.239</b>	<b>1.397</b>	<b>1.373</b>
2580	EMMS0465	<b>1.170</b>	<b>1.218</b>	<b>1.440</b>	<b>1.271</b>	<b>1.448</b>	<b>1.421</b>

L. 1425

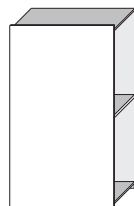

H.  
H.

CODICE  
CODE

EL. 1 ANTA da 1465 mm - escluso di fianchi e divisioni  
*EL. 1 DOOR 1465 mm - side panels and partitions not included*

2356	EMMS0375	<b>1.242</b>	<b>1.291</b>	<b>1.527</b>	<b>1.339</b>	<b>1.527</b>	<b>1.500</b>
2580	EMMS0475	<b>1.269</b>	<b>1.324</b>	<b>1.581</b>	<b>1.375</b>	<b>1.583</b>	<b>1.554</b>

Ulteriori combinazioni di aperture e finiture sono possibili utilizzando le scocche vuote a pag. | *Additional finishes and opening combinations are possible using the empty bodies on page 168*

# SCORREVOLE | SLIDING DOOR

green

										Maggiorazione per interno laccato opaco  <i>Increase for matt lacquered inside finish</i>
										<b>136</b>
										<b>142</b>
										<b>170</b>
										<b>176</b>
										<b>189</b>
										<b>199</b>

Ulteriori combinazioni di aperture e finiture sono possibili utilizzando le scocche vuote a pag. | *Additional finishes and opening combinations are possible using the empty bodies on page 168*

# SCORREVOLE | SLIDING DOOR

green

- **Attenzione: la finitura dei fianchi segue la finitura dell'anta.**  
 - *Attention: the finish of the sides matches the finish of the door.*

- **Prezzi calcolati con interno melaminico.**  
 - **Dotazione interna vano standard: - N. 1 ripiano - N. 2 tubi appendiabiti**  
 - *Prices calculated with melamine inside finish.*  
 - *Standard internal equipment: - 1 shelf - 2 clothes hangers*

- **Nell'anta GREEN la maniglia è inserita su pannello inferiore.**  
**Disponibile nelle finiture laccato opaco o lucido, rovere nodi o rovere termotrattato, rovere laccato poro aperto.**  
 - *The door GREEN is supplied with a handle built-in the lower panel.*  
*Available in matt or glossy lacquer, oak knots or heat-treated oak finish, lacq. open pore oak.*

GREEN lacc. opaco base <i>basic matt lacq.</i>	GREEN lacc. opaco colore <i>colour matt lacq.</i>	GREEN lacc. lucido <i>glossy lacq.</i>	GREEN essenza <i>wood</i>	GREEN rovere lacc. poro aperto <i>open pore lacq. oak</i>	GREEN rovere termotrattato <i>heat-treated oak</i>

Sezione ante | *Door section:*

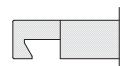

Model	H. H.	CODICE CODE	EL. 2 ANTE da 1021 mm EL. 2 DOORS 1021 mm	EL. 2 ANTE da 1265 mm EL. 2 DOORS 1265 mm	EL. 2 ANTE da 1465 mm EL. 2 DOORS 1465 mm	EL. 3 ANTE da 1021 mm EL. 3 DOORS 1021 mm	EL. 3 ANTE da 1021 mm EL. 3 DOORS 1021 mm	EL. 3 ANTE da 1021 mm EL. 3 DOORS 1021 mm	EL. 3 ANTE da 1021 mm EL. 3 DOORS 1021 mm	EL. 3 ANTE da 1021 mm EL. 3 DOORS 1021 mm
L. 2037 			2356 EMAS3200	2.257	2.353	2.837	2.520	2.856	2.804	
			2580 EMAS4200	2.315	2.417	2.950	2.596	2.969	2.909	
L. 2525 			2356 EMAS3230	2.611	2.725	3.287	2.896	3.302	3.238	
			2580 EMAS4230	2.681	2.805	3.422	2.986	3.439	3.365	
L. 2925 			2356 EMAS3280	2.805	2.931	3.559	3.096	3.562	3.492	
			2580 EMAS4280	2.879	3.017	3.704	3.194	3.709	3.631	
L. 3043 			2356 EMAS3300	3.306	3.436	4.080	3.649	4.106	4.040	
			2580 EMAS4300	3.387	3.524	4.232	3.754	4.261	4.183	

Ulteriori combinazioni di aperture e finiture sono possibili utilizzando le scocche vuote a pag. | *Additional finishes and opening combinations are possible using the empty bodies on page 168*

# SCORREVOLE | SLIDING DOOR

green

										Maggiorazione per interno laccato opaco <i>Increase for matt lacquered inside finish</i>
										<b>448</b>
										<b>473</b>
										<b>516</b>
										<b>541</b>
										<b>554</b>
										<b>587</b>
										<b>664</b>
										<b>702</b>

Ulteriori combinazioni di aperture e finiture sono possibili utilizzando le scocche vuote a pag. | *Additional finishes and opening combinations are possible using the empty bodies on page 168*

# SCORREVOLE | SLIDING DOOR

green

- **Attenzione: la finitura dei fianchi segue la finitura dell'anta.**  
- *Attention: the finish of the sides matches the finish of the door.*
- **Prezzi calcolati con interno melaminico.**  
- **Dotazione interna vano standard: - N. 1 ripiano - N. 2 tubi appendiabiti**  
- *Prices calculated with melamine inside finish.*  
- *Standard internal equipment: - 1 shelf - 2 clothes hangers*
- **Nell'anta GREEN la maniglia è inserita su pannello inferiore.**  
**Disponibile nelle finiture laccato opaco o lucido, rovere nodi o rovere termotrattato, rovere laccato poro aperto.**  
- *The door GREEN is supplied with a handle built-in the lower panel.*  
*Available in matt or glossy lacquer, oak knots or heat-treated oak finish, lacq. open pore oak.*

GREEN lacc. opaco base <i>basic matt lacq.</i>	GREEN lacc. opaco colore <i>colour matt lacq.</i>	GREEN lacc. lucido <i>glossy lacq.</i>	GREEN essenza <i>wood</i>	GREEN rovere lacc. poro aperto <i>open pore lacq. oak</i>	GREEN rovere termotrattato <i>heat-treated oak</i>

Sezione ante | Door section:

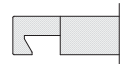

## L. 3775

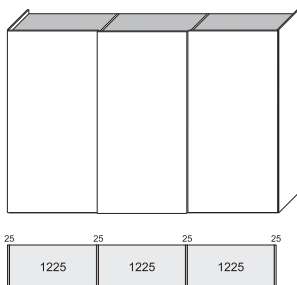

H. CODICE  
H. CODE  
EL. 3 ANTE da 1265 mm  
EL. 3 DOORS 1265 mm

2356	EMAS3360	<b>3.837</b>	<b>3.994</b>	<b>4.755</b>	<b>4.213</b>	<b>4.775</b>	<b>4.691</b>
2580	EMAS4360	<b>3.936</b>	<b>4.106</b>	<b>4.940</b>	<b>4.339</b>	<b>4.966</b>	<b>4.867</b>

## L. 4049

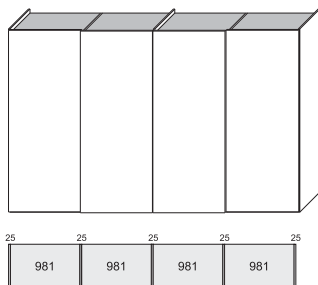

H. CODICE  
H. CODE  
EL. 4 ANTE da 1021 mm  
EL. 4 DOORS 1021 mm

2356	EMAS3400	<b>4.358</b>	<b>4.522</b>	<b>5.330</b>	<b>4.784</b>	<b>5.364</b>	<b>5.280</b>
2580	EMAS4400	<b>4.462</b>	<b>4.636</b>	<b>5.524</b>	<b>4.918</b>	<b>5.562</b>	<b>5.464</b>

Ulteriori combinazioni di aperture e finiture sono possibili utilizzando le scocche vuote a pag. | Additional finishes and opening combinations are possible using the empty bodies on page 168



# SCORREVOLE | SLIDING DOOR

green

										Maggiorazione per interno laccato opaco <i>Increase for matt lacquered inside finish</i>
										<b>766</b>
										<b>804</b>
										<b>882</b>
										<b>934</b>

Ulteriori combinazioni di aperture e finiture sono possibili utilizzando le scocche vuote a pag. | Additional finishes and opening combinations are possible using the empty bodies on page 168

# SCORREVOLE | SLIDING DOOR

vertical

- Fianchi e divisioni a pag. | Side panels and partitions on page 96







- Prezzi calcolati con interno melaminico.

Dotazione interna vano standard: - N. 1 ripiano - N. 2 tubi appendiabiti

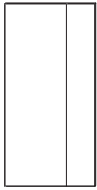
- Prices calculated with melamine inside finish.







Standard internal equipment: - 1 shelf - 2 clothes hangers

Maniglie a pag. | Handles on page 89

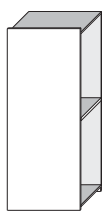
VERTICAL lacc. opaco base basic matt lacq.	VERTICAL lacc. opaco colore colour matt lacq.	VERTICAL lacc. lucido glossy lacq.	VERTICAL lacc. opaco / essenza matt lacq. / wood	VERTICAL lacc. lucido / essenza glossy lacq. / wood	VERTICAL l. opaco / rovere p.a. matt lacq. / open pore oak
					

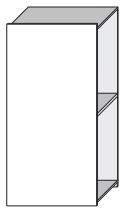
Sezione ante | Door section:

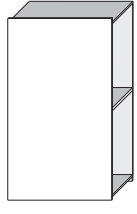





L. 981	H. H.	CODICE CODE	EL. 1 ANTA da 1021 mm - escluso di fianchi e divisioni EL. 1 DOOR 1021 mm - side panels and partitions not included								
			736	788	1.037	883	1.035	963			
											
											
		2356	EMMS0355	<b>736</b>	<b>788</b>	<b>1.037</b>	<b>883</b>	<b>1.035</b>	<b>963</b>		
		2580	EMMS0455	<b>758</b>	<b>806</b>	<b>1.074</b>	<b>909</b>	<b>1.072</b>	<b>995</b>		
L. 1225	H. H.	CODICE CODE	EL. 1 ANTA da 1265 mm - escluso di fianchi e divisioni EL. 1 DOOR 1265 mm - side panels and partitions not included								
			897	958	1.259	1.053	1.257	1.133			
											
											
		2356	EMMS0365	<b>897</b>	<b>958</b>	<b>1.259</b>	<b>1.053</b>	<b>1.257</b>	<b>1.133</b>		
		2580	EMMS0465	<b>924</b>	<b>980</b>	<b>1.305</b>	<b>1.083</b>	<b>1.303</b>	<b>1.169</b>		
L. 1425	H. H.	CODICE CODE	EL. 1 ANTA da 1465 mm - escluso di fianchi e divisioni EL. 1 DOOR 1465 mm - side panels and partitions not included								
			982	1.050	1.395	1.145	1.393	1.225			
											
											
		2356	EMMS0375	<b>982</b>	<b>1.050</b>	<b>1.395</b>	<b>1.145</b>	<b>1.393</b>	<b>1.225</b>		
		2580	EMMS0475	<b>1.010</b>	<b>1.073</b>	<b>1.444</b>	<b>1.176</b>	<b>1.442</b>	<b>1.262</b>		

Ulteriori combinazioni di aperture e finiture sono possibili utilizzando le scocche vuote a pag. | Additional finishes and opening combinations are possible using the empty bodies on page 168

# SCORREVOLE | SLIDING DOOR

## vertical

VERTICAL l. lucido / rovere p.a. <i>glossy lacq. / open pore oak</i>	VERTICAL l. opaco / rovere termotrattato <i>mat lacq. / heat-treated oak</i>	VERTICAL l. lucido / rovere termotrattato <i>glossy lacq. / heat-treated oak</i>							Maggiorazione per interno laccato opaco  <i>Increase for matt lacquered inside finish</i>
									
 30									
EL. 1 ANTA da 1021 mm - escluso di fianchi e divisioni <i>EL. 1 DOOR 1021 mm - side panels and partitions not included</i>									
<b>1.115</b>	<b>946</b>	<b>1.098</b>							<b>136</b>
<b>1.158</b>	<b>976</b>	<b>1.139</b>							<b>142</b>
EL. 1 ANTA da 1265 mm - escluso di fianchi e divisioni <i>EL. 1 DOOR 1265 mm - side panels and partitions not included</i>									
<b>1.337</b>	<b>1.116</b>	<b>1.320</b>							<b>170</b>
<b>1.389</b>	<b>1.150</b>	<b>1.370</b>							<b>176</b>
EL. 1 ANTA da 1465 mm - escluso di fianchi e divisioni <i>EL. 1 DOOR 1465 mm - side panels and partitions not included</i>									
<b>1.473</b>	<b>1.208</b>	<b>1.456</b>							<b>189</b>
<b>1.528</b>	<b>1.243</b>	<b>1.509</b>							<b>199</b>

Ulteriori combinazioni di aperture e finiture sono possibili utilizzando le scocche vuote a pag. | *Additional finishes and opening combinations are possible using the empty bodies on page 168*







# SCORREVOLE | SLIDING DOOR

## vertical

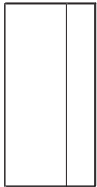
- **Attenzione: la finitura dei fianchi segue la finitura del pannello A**  
 - *Attention: the finish of the sides matches the finish of panel A*



- **Prezzi calcolati con interno melaminico.**  
 Dotazione interna vano standard: - N. 1 ripiano - N. 2 tubi appendiabiti  
 - *Prices calculated with melamine inside finish.*  
 Standard internal equipment: - 1 shelf - 2 clothes hangers

**Maniglie a pag. | Handles on page 89**

VERTICAL lacc. opaco base basic matt lacq.	VERTICAL lacc. opaco colore colour matt lacq.	VERTICAL lacc. lucido glossy lacq.	VERTICAL lacc. opaco / essenza matt lacq. / wood	VERTICAL lacc. lucido / essenza glossy lacq. / wood	VERTICAL l. opaco / rovere p.a. matt lacq. / open pore oak
					

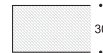
Sezione ante | Door section:

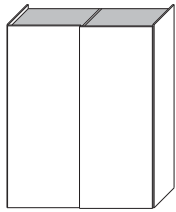

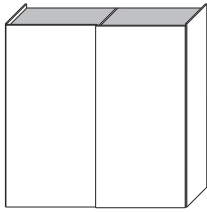
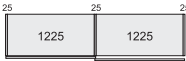
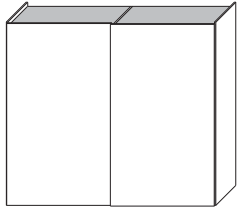
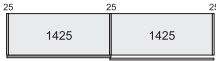
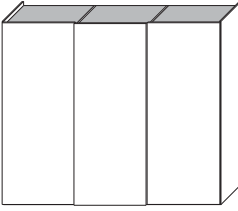
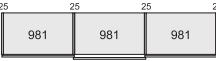
L. 2037	H. H.	CODICE CODE	EL. 2 ANTE da 1021 mm EL. 2 DOORS 1021 mm								
 				2356	EMAS3200	<b>1.793</b>	<b>1.925</b>	<b>2.579</b>	<b>2.115</b>	<b>2.575</b>	<b>2.275</b>
				2580	EMAS4200	<b>1.857</b>	<b>1.981</b>	<b>2.690</b>	<b>2.187</b>	<b>2.686</b>	<b>2.359</b>
 				2356	EMAS3230	<b>2.115</b>	<b>2.265</b>	<b>3.023</b>	<b>2.455</b>	<b>3.019</b>	<b>2.615</b>
				2580	EMAS4230	<b>2.189</b>	<b>2.329</b>	<b>3.152</b>	<b>2.535</b>	<b>3.148</b>	<b>2.707</b>
 				2356	EMAS3280	<b>2.285</b>	<b>2.449</b>	<b>3.295</b>	<b>2.639</b>	<b>3.291</b>	<b>2.799</b>
				2580	EMAS4280	<b>2.361</b>	<b>2.515</b>	<b>3.430</b>	<b>2.721</b>	<b>3.426</b>	<b>2.893</b>
 				2356	EMAS3300	<b>2.610</b>	<b>2.794</b>	<b>3.693</b>	<b>3.079</b>	<b>3.687</b>	<b>3.319</b>
				2580	EMAS4300	<b>2.700</b>	<b>2.870</b>	<b>2.842</b>	<b>3.179</b>	<b>3.836</b>	<b>3.437</b>

Ulteriori combinazioni di aperture e finiture sono possibili utilizzando le scocche vuote a pag. | Additional finishes and opening combinations are possible using the empty bodies on page 168

# SCORREVOLE | SLIDING DOOR

## vertical

<b>VERTICAL</b> l. lucido / rovere p.a. <i>glossy lacq. / open pore oak</i>			<b>VERTICAL</b> l. opaco / rovere termotrattato <i>matl lacq. / heat-treated oak</i>			<b>VERTICAL</b> l. lucido / rovere termotrattato <i>glossy lacq. / heat-treated oak</i>						Maggiorazione per interno laccato opaco  <i>Increase                      for matl lacquered                      inside finish</i>
EL. 2 ANTE da 1021 mm EL. 2 DOORS 1021 mm												
<b>2.735</b>	<b>2.241</b>	<b>2.701</b>										<b>449</b>
<b>2.858</b>	<b>2.321</b>	<b>2.820</b>										<b>473</b>
EL. 2 ANTE da 1265 mm EL. 2 DOORS 1265 mm												
<b>3.179</b>	<b>2.581</b>	<b>3.145</b>										<b>516</b>
<b>3.320</b>	<b>2.669</b>	<b>3.282</b>										<b>541</b>
EL. 2 ANTE da 1465 mm EL. 2 DOORS 1465 mm												
<b>3.451</b>	<b>2.765</b>	<b>3.417</b>										<b>554</b>
<b>3.598</b>	<b>2.855</b>	<b>3.560</b>										<b>587</b>
EL. 3 ANTE da 1021 mm EL. 3 DOORS 1021 mm												
<b>3.927</b>	<b>3.268</b>	<b>3.876</b>										<b>664</b>
<b>4.094</b>	<b>3.380</b>	<b>4.037</b>										<b>702</b>

Ulteriori combinazioni di aperture e finiture sono possibili utilizzando le scocche vuote a pag. | Additional finishes and opening combinations are possible using the empty bodies on page 168







# SCORREVOLE | SLIDING DOOR

## vertical

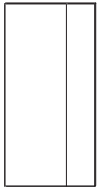
- **Attenzione: la finitura dei fianchi segue la finitura del pannello A**  
 - *Attention: the finish of the sides matches the finish of panel A*

- **Prezzi calcolati con interno melaminico.**  
 Dotazione interna vano standard: - N. 1 ripiano - N. 2 tubi appendiabiti  
 - *Prices calculated with melamine inside finish.*  
 Standard internal equipment: - 1 shelf - 2 clothes hangers

**Maniglie a pag. | Handles on page 89**

<b>VERTICAL</b> lacc. opaco base <i>basic matt lacq.</i>	<b>VERTICAL</b> lacc. opaco colore <i>colour matt lacq.</i>	<b>VERTICAL</b> lacc. lucido <i>glossy lacq.</i>	<b>VERTICAL</b> lacc. opaco / essenza <i>matt lacq. / wood</i>	<b>VERTICAL</b> lacc. lucido / essenza <i>glossy lacq. / wood</i>	<b>VERTICAL</b> l. opaco / rovere p.a. <i>matt lacq. / open pore oak</i>
					

**Sezione ante | Door section:**



### L. 3775

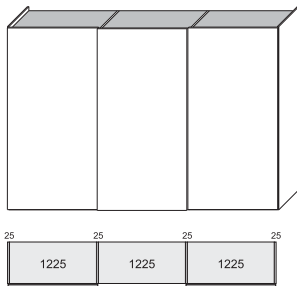

H. CODICE EL. 3 ANTE da 1265 mm  
 H. CODE EL. 3 DOORS 1265 mm

2356	EMAS3360	<b>3.093</b>	<b>3.304</b>	<b>4.359</b>	<b>3.589</b>	<b>4.353</b>	<b>3.829</b>
2580	EMAS4360	<b>3.198</b>	<b>3.392</b>	<b>4.535</b>	<b>3.701</b>	<b>4.529</b>	<b>3.959</b>

### L. 4049

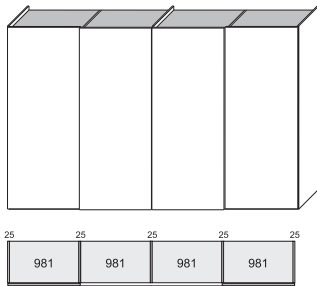





H. CODICE EL. 4 ANTE da 1021 mm  
 H. CODE EL. 4 DOORS 1021 mm

2356	EMAS3400	<b>3.430</b>	<b>3.666</b>	<b>4.814</b>	<b>4.046</b>	<b>4.806</b>	<b>4.366</b>
2580	EMAS4400	<b>3.546</b>	<b>3.764</b>	<b>5.004</b>	<b>4.176</b>	<b>4.996</b>	<b>4.520</b>

Ulteriori combinazioni di aperture e finiture sono possibili utilizzando le scocche vuote a pag. | *Additional finishes and opening combinations are possible using the empty bodies on page 168*

# SCORREVOLE | SLIDING DOOR

















## vertical

VERTICAL l. lucido / rovere p.a. <i>glossy lacq. / open pore oak</i>	VERTICAL l. opaco / rovere termotrattato <i>matt lacq. / heat-treated oak</i>	VERTICAL l. lucido / rovere termotrattato <i>glossy lacq. / heat-treated oak</i>								Maggiorazione per interno laccato opaco  <i>Increase for matt lacquered inside finish</i>
										
										
EL. 3 ANTE da 1265 mm <i>EL. 3 DOORS 1265 mm</i>										
<b>4.593</b>	<b>3.778</b>	<b>4.542</b>								<b>766</b>
<b>4.787</b>	<b>3.902</b>	<b>4.730</b>								<b>804</b>
EL. 4 ANTE da 1021 mm <i>EL. 4 DOORS 1021 mm</i>										
<b>5.126</b>	<b>4.298</b>	<b>5.058</b>								<b>882</b>
<b>5.340</b>	<b>4.444</b>	<b>5.264</b>								<b>934</b>

Ulteriori combinazioni di aperture e finiture sono possibili utilizzando le scocche vuote a pag. | *Additional finishes and opening combinations are possible using the empty bodies on page 168*

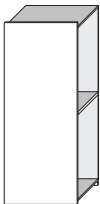
# SCORREVOLE | SLIDING DOOR

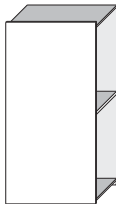
riga

<ul style="list-style-type: none"> <li>- Fianchi e divisioni a pag.   <i>Side panels and partitions on page 96</i></li> <li>- Prezzi calcolati con interno melaminico.</li> <li>- Dotazione interna vano standard: - N. 1 ripiano - N. 2 tubi appendiabiti</li> <li>- <i>Prices calculated with melamine inside finish.</i></li> <li>- <i>Standard internal equipment: - 1 shelf - 2 clothes hangers</i></li> <li>- Maniglia: LAMA H. 40, vedi pag.   <i>Handle: LAMA H.40, see page 89</i></li> <li>- La fascia centrale è disponibile nelle finiture laccato opaco - laccato lucido - rovere nodi - rovere termotrattato - rovere laccato poro aperto - rovere moro - rovere tabacco</li> <li>- <i>The centre strip is available in matt-glossy lacquer finish or in oak knots or heat-treated oak finish - lacq. open pore - oak in mahogany-tobacco finish.</i></li> </ul>		<table border="1"> <tr> <th>RIGA lacc. opaco base <i>basic matt lacq.</i></th> <th>RIGA lacc. opaco colore <i>colour matt lacq.</i></th> <th>RIGA lacc. lucido <i>glossy lacq.</i></th> </tr> <tr> <td></td> <td></td> <td></td> </tr> </table>			RIGA lacc. opaco base <i>basic matt lacq.</i>	RIGA lacc. opaco colore <i>colour matt lacq.</i>	RIGA lacc. lucido <i>glossy lacq.</i>				<table border="1"> <tr> <td colspan="2">Sezione ante   <i>Door section:</i></td> <td></td> <td>30</td> <td colspan="2"></td> </tr> </table>					Sezione ante   <i>Door section:</i>			30		
		RIGA lacc. opaco base <i>basic matt lacq.</i>	RIGA lacc. opaco colore <i>colour matt lacq.</i>	RIGA lacc. lucido <i>glossy lacq.</i>																	
																					
Sezione ante   <i>Door section:</i>			30																		
L. 981	H. H.	CODICE CODE	EL. 1 ANTA da 1021 mm - escluso di fianchi e divisioni <i>EL. 1 DOOR 1021 mm - side panels and partitions not included</i>																		
 		2356 EMMS0355	<b>856</b>	<b>886</b>	<b>1.048</b>																
		2580 EMMS0455	<b>874</b>	<b>908</b>	<b>1.086</b>																
L. 1225	H. H.	CODICE CODE	EL. 1 ANTA da 1265 mm - escluso di fianchi e divisioni <i>EL. 1 DOOR 1265 mm - side panels and partitions not included</i>																		
 		2356 EMMS0365	<b>1.040</b>	<b>1.078</b>	<b>1.279</b>																
		2580 EMMS0465	<b>1.064</b>	<b>1.106</b>	<b>1.326</b>																

Ulteriori combinazioni di aperture e finiture sono possibili utilizzando le scocche vuote a pag. | *Additional finishes and opening combinations are possible using the empty bodies on page 168*



# SCORREVOLE | SLIDING DOOR









riga

										Maggiorazione per interno laccato opaco  <i>Increase for matt lacquered inside finish</i>
										<b>136</b>
										<b>142</b>
										<b>170</b>
										<b>176</b>

Ulteriori combinazioni di aperture e finiture sono possibili utilizzando le scocche vuote a pag. | *Additional finishes and opening combinations are possible using the empty bodies on page 168*

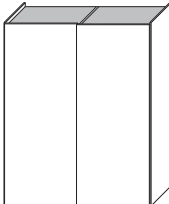
# SCORREVOLE | SLIDING DOOR

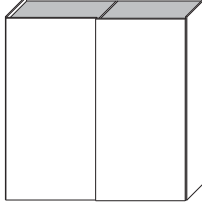
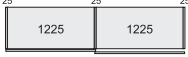
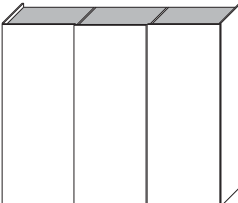
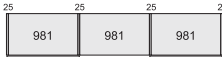
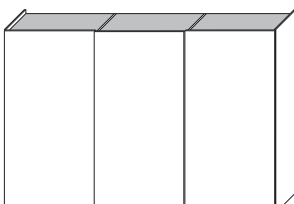
riga

<p>- <b>Attenzione: la finitura dei fianchi segue la finitura dell'anta.</b> - <i>Attention: the finish of the sides matches the finish of the door.</i></p> <p>- <b>Prezzi calcolati con interno melaminico.</b> - <b>Dotazione interna vano standard: - N. 1 ripiano - N. 2 tubi appendiabiti</b> - <i>Prices calculated with melamine inside finish.</i> - <i>Standard internal equipment: - 1 shelf - 2 clothes hangers</i></p> <p>- <b>Maniglia: LAMA H. 40, vedi pag.   Handle: LAMA H.40, see page 89</b></p> <p>- <b>La fascia centrale è disponibile nelle finiture laccato opaco - laccato lucido - rovere nodi - rovere termotrattato - rovere laccato poro aperto - rovere moro - rovere tabacco</b> - <i>The central strip is available in matt-glossy lacquer finish or in oak knots or heat-treated oak finish - lacq. open pore - oak in mahogany-tobacco finish.</i></p>		<p><b>RIGA</b> lacc. opaco base <i>basic matt lacq.</i></p> 	<p><b>RIGA</b> lacc. opaco colore <i>colour matt lacq.</i></p> 	<p><b>RIGA</b> lacc. lucido <i>glossy lacq.</i></p> 				
		<p><b>Sezione ante   Door section:</b></p> 						
<p><b>L. 2037</b></p>  	<p>H. H.</p>	<p>CODICE CODE</p>	<p>EL. 2 ANTE da 1021 mm EL. 2 DOORS 1021 mm</p>					
			2356	EMAS3200	<b>2.033</b>	<b>2.121</b>	<b>2.601</b>	
			2580	EMAS4200	<b>2.089</b>	<b>2.185</b>	<b>2.714</b>	
<p><b>L. 2525</b></p>  	<p>H. H.</p>	<p>CODICE CODE</p>	<p>EL. 2 ANTE da 1265 mm EL. 2 DOORS 1265 mm</p>					
			2356	EMAS3230	<b>2.401</b>	<b>2.505</b>	<b>3.063</b>	
			2580	EMAS4230	<b>2.469</b>	<b>2.581</b>	<b>3.194</b>	
<p><b>L. 3043</b></p>  	<p>H. H.</p>	<p>CODICE CODE</p>	<p>EL. 3 ANTE da 1021 mm EL. 3 DOORS 1021 mm</p>					
			2356	EMAS3300	<b>2.970</b>	<b>3.088</b>	<b>3.726</b>	
			2580	EMAS4300	<b>3.048</b>	<b>3.176</b>	<b>3.878</b>	
<p><b>L. 3775</b></p>  	<p>H. H.</p>	<p>CODICE CODE</p>	<p>EL. 3 ANTE da 1265 mm EL. 3 DOORS 1265 mm</p>					
			2356	EMAS3360	<b>3.522</b>	<b>3.664</b>	<b>4.419</b>	
			2580	EMAS4360	<b>3.618</b>	<b>3.370</b>	<b>4.598</b>	

Ulteriori combinazioni di aperture e finiture sono possibili utilizzando le scocche vuote a pag. | *Additional finishes and opening combinations are possible using the empty bodies on page 168*

# SCORREVOLE | SLIDING DOOR

riga

										Maggiorazione per interno laccato opaco  <i>Increase for matt lacquered inside finish</i>
										<b>448</b>
										<b>473</b>
										<b>516</b>
										<b>541</b>
										<b>664</b>
										<b>702</b>
										<b>766</b>
										<b>804</b>

Ulteriori combinazioni di aperture e finiture sono possibili utilizzando le scocche vuote a pag. | Additional finishes and opening combinations are possible using the empty bodies on page 168

# SCORREVOLE | SLIDING DOOR

## riga

- **Attenzione: la finitura dei fianchi segue la finitura dell'anta.**  
 - *Attention: the finish of the sides matches the finish of the door.*

- **Prezzi calcolati con interno melaminico.**  
 - **Dotazione interna vano standard: - N. 1 ripiano - N. 2 tubi appendiabiti**  
 - *Prices calculated with melamine inside finish.*  
 - *Standard internal equipment: - 1 shelf - 2 clothes hangers*

- **Maniglia: LAMA H. 40, vedi pag. | Handle: LAMA H.40, see page 89**

- **La fascia centrale è disponibile nelle finiture laccato opaco - laccato lucido - rovere nodi - rovere termotrattato - rovere laccato poro aperto - rovere moro - rovere tabacco**

- *The central strip is available in matt-glossy lacquer finish or in oak knots or heat-treated oak finish - lacq. open pore - oak in mahogany-tobacco finish.*

**RIGA**  
**lacc. opaco base**  
*basic matt lacq.*



**RIGA**  
**lacc. opaco colore**  
*colour matt lacq.*



**RIGA**  
**lacc. lucido**  
*glossy lacq.*



**Sezione ante | Door section:**



**L. 4049**

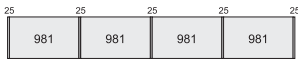
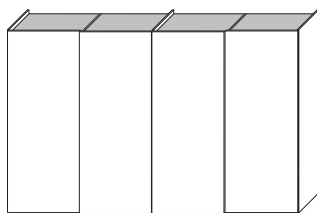

H.  
H.

CODICE  
CODE

EL. 4 ANTE da 1021 mm  
 EL. 4 DOORS 1021 mm

2356	EMAS3400	<b>3.910</b>	<b>4.058</b>	<b>4.858</b>			
2580	EMAS4400	<b>4.010</b>	<b>4.172</b>	<b>5.052</b>			

Ulteriori combinazioni di aperture e finiture sono possibili utilizzando le scocche vuote a pag. | *Additional finishes and opening combinations are possible using the empty bodies on page 168*

# SCORREVOLE | *SLIDING DOOR*

riga







									Maggiorazione per interno laccato opaco <i>Increase for matt lacquered inside finish</i>
									<b>882</b>
									<b>934</b>

Ulteriori combinazioni di aperture e finiture sono possibili utilizzando le scocche vuote a pag. | *Additional finishes and opening combinations are possible using the empty bodies on page 168*

# COMPLANARE | FLUSH-FITTING

composta

- **Attenzione: la finitura dei fianchi segue la finitura dell'anta (ES: anta essenza - fianco essenza / anta mista - fianco come pannelli grandi).**
- **Attention: the finish of the sides follows the finish of the door (EX. wooden door - wooden side / mixed door - side like big panels).**
- **Prezzi calcolati con interno melaminico.**
- **Dotazione interna vano standard: - N. 1 ripiano - N. 2 tubi appendiabiti**
- **Prices calculated with melamine inside finish.**
- **Standard internal equipment: - 1 shelf - 2 clothes hangers**
- **Prezzo già comprensivo di maniglie Vip. Maggiorazione per maniglie laccato opaco colore di 24 euro.**
- **Price includes Vip handles. Increase for matt lacquered handles euro 24.**
- **Il pannello centrale inoltre è disponibile anche con incisioni (motivo ad onda) su pannello rovere laccato poro aperto.**
- **The middle panel is also available with engravings (wave design) on open pore lacq. oak.**

<b>COMPOSTA</b> lacc. opaco base <i>basic matt lacq.</i>	<b>COMPOSTA</b> lacc. opaco colore <i>colour matt lacq.</i>	<b>COMPOSTA</b> essenza <i>wood</i>	<b>COMPOSTA</b> rovere lacc. poro aperto <i>open pore lacq. oak</i>	<b>COMPOSTA</b> rovere termotrattato <i>heat-treated oak</i>	<b>COMPOSTA</b> lacc. lucido <i>glossy lacq.</i>
					

Sezione ante | Door section:



**L. 2525**

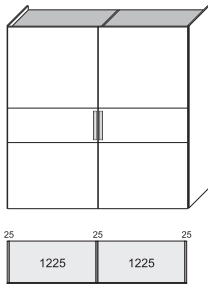

H.  
H.

CODICE  
CODE

EL. 2 ANTE da 1265 mm  
EL. 2 DOORS 1265 mm

2356	EMAC3230	<b>3.810</b>	<b>3.924</b>	<b>4.092</b>	<b>4.496</b>	<b>4.436</b>	<b>4.482</b>
2580	EMAC4230	<b>3.881</b>	<b>4.003</b>	<b>4.183</b>	<b>4.633</b>	<b>4.561</b>	<b>4.615</b>

**L. 2925**

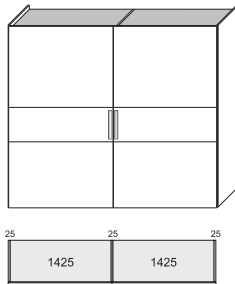

H.  
H.

CODICE  
CODE

EL. 2 ANTE da 1465 mm  
EL. 2 DOORS 1465 mm

2356	EMAC3280	<b>4.068</b>	<b>4.194</b>	<b>4.356</b>	<b>4.820</b>	<b>4.754</b>	<b>4.818</b>
2580	EMAC4280	<b>4.143</b>	<b>4.279</b>	<b>4.455</b>	<b>4.967</b>	<b>4.891</b>	<b>4.961</b>

Ulteriori combinazioni di aperture e finiture sono possibili utilizzando le scocche vuote a pag. | Additional finishes and opening combinations are possible using the empty bodies on page 164

# COMPLANARE | FLUSH-FITTING

## composta

COMPOSTA l. opaco colore / essenza <i>colour matt l. / wood</i>	COMPOSTA l. opaco / rovere termotr. <i>matt l. / heat-treated oak</i>	COMPOSTA lacc. lucido / essenza <i>glossy lacq. / wood</i>	COMPOSTA l. lucido / rovere termotr. <i>glossy l. / heat-treated oak</i>	COMPOSTA l. o. colore / rovere p. a. <i>col. matt lacq. / o. p. oak</i>	COMPOSTA l. opaco colore / onda <i>col. matt lacq. / wave</i>	COMPOSTA rovere poro aperto / onda <i>open pore oak l. / wave</i>			Maggiorazione per interno laccato opaco  <i>Increase for matt lacquered inside finish</i>
EL. 2 ANTE da 1265 mm <i>EL. 2 DOORS 1265 mm</i>									
<b>3.942</b>	<b>3.992</b>	<b>4.426</b>	<b>4.476</b>	<b>4.004</b>	<b>4.076</b>	<b>4.568</b>			<b>512</b>
<b>4.021</b>	<b>4.071</b>	<b>4.559</b>	<b>4.609</b>	<b>4.083</b>	<b>4.155</b>	<b>4.705</b>			<b>538</b>
EL. 2 ANTE da 1465 mm <i>EL. 2 DOORS 1465 mm</i>									
<b>4.212</b>	<b>4.272</b>	<b>4.748</b>	<b>4.808</b>	<b>4.284</b>	<b>4.358</b>	<b>4.894</b>			<b>550</b>
<b>4.297</b>	<b>4.357</b>	<b>4.891</b>	<b>4.951</b>	<b>4.369</b>	<b>4.443</b>	<b>5.041</b>			<b>584</b>

Ulteriori combinazioni di aperture e finiture sono possibili utilizzando le scocche vuote a pag. | *Additional finishes and opening combinations are possible using the empty bodies on page 164*

# COMPLANARE | FLUSH-FITTING

## composta plus

- **Attenzione: la finitura dei fianchi segue la finitura dell'anta (ES: anta essenza - fianco essenza / anta mista - fianco come pannelli grandi).**
- **Attention: the finish of the sides follows the finish of the door (EX. wooden door - wooden side / mixed door - side like big panels).**
- **Prezzi calcolati con interno melaminico.**
- **Dotazione interna vano standard: - N. 1 ripiano - N. 2 tubi appendiabiti**
- **Prices calculated with melamine inside finish.**
- **Standard internal equipment: - 1 shelf - 2 clothes hangers**
- **Nell'anta COMPOSTA PLUS la maniglia è inserita su pannello centrale.**
- **Disponibile nelle finiture laccato opaco o lucido, rovere lacc. poro aperto, rovere moro, rovere tabacco, rovere nodi o rovere termotrattato.**
- **The door COMPOSTA PLUS is supplied with a handle built-in the central panel.**
- **Available in matt or glossy lacquer, open-pore lacquered oak, oak in mahogany-tobacco finish, oak knots or heat-treated oak.**
- **Il pannello centrale inoltre è disponibile anche con incisioni (motivo ad onda) su pannello rovere laccato poro aperto.**
- **The middle panel is also available with engravings (wave design) on open pore lacq. oak.**

COMPOSTA PLUS  
lacc. opaco base  
basic matt lacq.

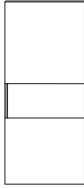

COMPOSTA PLUS  
lacc. opaco colore  
colour matt lacq.

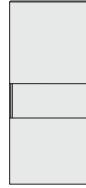

COMPOSTA PLUS  
essenza  
wood



COMPOSTA PLUS  
rovere lacc. poro aperto  
open pore lacq. oak



COMPOSTA PLUS  
rovere termotrattato  
heat-treated oak



COMPOSTA PLUS  
lacc. lucido  
glossy lacq.



Sezione ante | Door section:

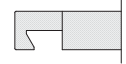

L. 2525

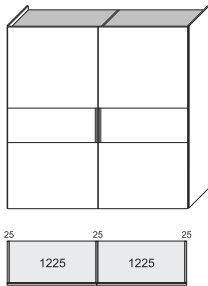

H.  
H.

CODICE  
CODE

EL. 2 ANTE da 1265 mm  
EL. 2 DOORS 1265 mm

2356 EMAC3230

3.810

3.924

4.092

4.492

4.436

4.482

2580 EMAC4230

3.881

4.003

4.183

4.633

4.561

4.615

L. 2925

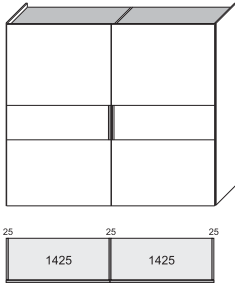

H.  
H.

CODICE  
CODE

EL. 2 ANTE da 1465 mm  
EL. 2 DOORS 1465 mm

2356 EMAC3280

4.068

4.194

4.356

4.820

4.754

4.818

2580 EMAC4280

4.143

4.279

4.455

4.967

4.891







4.961

Ulteriori combinazioni di aperture e finiture sono possibili utilizzando le scocche vuote a pag. | Additional finishes and opening combinations are possible using the empty bodies on page 164



# COMPLANARE | FLUSH-FITTING

## composta plus

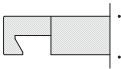
COMPOSTA PLUS l. opaco colore / essenza <i>colour matt l. / wood</i>	COMPOSTA PLUS l. opaco / rovere termotr. <i>matt l. / heat-treated oak</i>	COMPOSTA PLUS lacc. lucido / essenza <i>glossy lacq. / wood</i>	COMPOSTA PLUS l. lucido / rovere termotr. <i>glossy l. / heat-treated oak</i>	COMPOSTA PLUS l. o. colore / rovere p. a. <i>col. matt lacq. / o. p. oak</i>	COMPOSTA PLUS l. opaco colore / onda <i>col. matt lacq. / wave</i>	COMPOSTA PLUS rovere poro aperto / onda <i>open pore oak l. / wave</i>			Maggiorazione per interno laccato opaco  <i>Increase for matt lacquered inside finish</i>
									
									
EL. 2 ANTE da 1265 mm <i>EL. 2 DOORS 1265 mm</i>									
<b>3.942</b>	<b>3.992</b>	<b>4.426</b>	<b>4.476</b>	<b>4.004</b>	<b>4.076</b>	<b>4.568</b>			<b>512</b>
<b>4.021</b>	<b>4.071</b>	<b>4.559</b>	<b>4.609</b>	<b>4.083</b>	<b>4.155</b>	<b>4.705</b>			<b>538</b>
EL. 2 ANTE da 1465 mm <i>EL. 2 DOORS 1465 mm</i>									
<b>4.212</b>	<b>4.272</b>	<b>4.748</b>	<b>4.808</b>	<b>4.284</b>	<b>4.358</b>	<b>4.894</b>			<b>550</b>
<b>4.297</b>	<b>4.357</b>	<b>4.891</b>	<b>4.951</b>	<b>4.369</b>	<b>4.443</b>	<b>5.041</b>			<b>584</b>

Ulteriori combinazioni di aperture e finiture sono possibili utilizzando le scocche vuote a pag. | *Additional finishes and opening combinations are possible using the empty bodies on page 164*

# COMPLANARE | FLUSH-FITTING

## green complanare

- **Attenzione: la finitura dei fianchi segue la finitura dell'anta.**  
 - *Attention: the finish of the sides matches the finish of the door.*

- **Prezzi calcolati con interno melaminico.**  
 - **Dotazione interna vano standard: - N. 1 ripiano - N. 2 tubi appendiabiti**  
 - *Prices calculated with melamine inside finish.*  
 - *Standard internal equipment: - 1 shelf - 2 clothes hangers*

- **Nell'anta GREEN la maniglia è inserita su pannello inferiore.**  
**Disponibile nelle finiture laccato opaco o lucido, rovere nodi o rovere termotrattato, rovere laccato poro aperto, rovere moro, rovere tabacco.**  
 - *The door GREEN is supplied with a handle built-in the lower panel.*  
*Available in matt or glossy lacquer, oak knots or heat-treated oak finish, lacq. open pore, ak in mahogany-tobacco finish.*

<b>GREEN</b> lacc. opaco base <i>basic matt lacq.</i>	<b>GREEN</b> lacc. opaco colore <i>colour matt lacq.</i>	<b>GREEN</b> lacc. lucido <i>glossy lacq.</i>	<b>GREEN</b> essenza <i>wood</i>	<b>GREEN</b> rovere lacc. poro aperto <i>open pore lacq. oak</i>	<b>GREEN</b> rovere termotrattato <i>heat-treated oak</i>

Sezione ante | *Door section:*

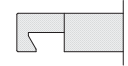

### L. 2525

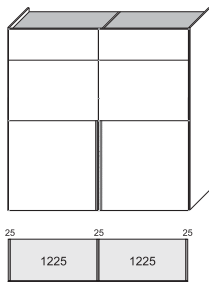

H.  
H.

CODICE  
CODE

EL. 2 ANTE da 1265 mm  
EL. 2 DOORS 1265 mm

2356	EMAC3230	<b>3.930</b>	<b>4.044</b>	<b>4.602</b>	<b>4.212</b>	<b>4.616</b>	<b>4.556</b>
2580	EMAC4230	<b>4.001</b>	<b>4.123</b>	<b>4.735</b>	<b>4.303</b>	<b>4.753</b>	<b>4.681</b>

### L. 2925

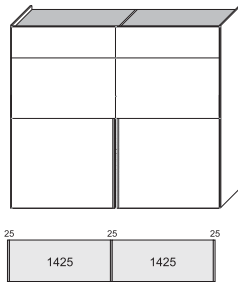

H.  
H.

CODICE  
CODE

EL. 2 ANTE da 1465 mm  
EL. 2 DOORS 1465 mm

2356	EMAC3280	<b>4.188</b>	<b>4.314</b>	<b>4.938</b>	<b>4.476</b>	<b>4.940</b>	<b>4.874</b>
2580	EMAC4280	<b>4.263</b>	<b>4.399</b>	<b>5.081</b>	<b>4.575</b>	<b>5.087</b>	<b>5.011</b>

Ulteriori combinazioni di aperture e finiture sono possibili utilizzando le scocche vuote a pag. | *Additional finishes and opening combinations are possible using the empty bodies on page 164*

# COMPLANARE | *FLUSH-FITTING*

green complanare

									Maggiorazione per interno laccato opaco  <i>Increase for matt lacquered inside finish</i>
									<b>512</b>
									<b>538</b>
									<b>550</b>
									<b>584</b>

Ulteriori combinazioni di aperture e finiture sono possibili utilizzando le scocche vuote a pag. | *Additional finishes and opening combinations are possible using the empty bodies on page 164*

# COMPLANARE | FLUSH-FITTING

scocche vuote e fianchi | empty bodies and side panels

- Il prezzo dell'armadio complanare si ottiene sommando il prezzo della scocca vuota + 2 fianchi p. 585 + 2 ante complanari.  
 - Price for flush-fitting doors wardrobe is obtained by adding the price of: empty body + 2 side panels p. 585 + 2 flush-fitting doors.

- Dotazione interna vano standard:  
 N. 1 ripiano - N. 2 tubi appendiabiti  
 - Standard internal equipment:  
 1 shelf - 2 clothes hangers

CODICE	melaminico magnolia	melaminico decorativo tessuto	melaminico rovere termotrattato	lacc. opaco				
CODE	magnolia melamine	decorative material melamine	heat-treated oak melamine	matt lacq.				

EL. 2 ANTE da 1247 mm - escluso di fianchi e ante  
 EL. 2 DOORS 1247 mm - side panels and doors not included

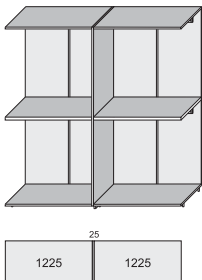

L. | W. 2475

H. 2356	EMAC3230	<b>2.126</b>	<b>2.126</b>	<b>2.126</b>	<b>2.550</b>			
H. 2580	EMAC4230	<b>2.143</b>	<b>2.143</b>	<b>2.143</b>	<b>2.584</b>			

EL. 2 ANTE da 1447 mm - escluso di fianchi e ante  
 EL. 2 DOORS 1447 mm - side panels and doors not included

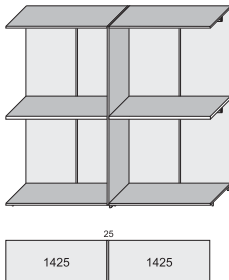

L. | W. 2875

H. 2356	EMAC3280	<b>2.270</b>	<b>2.270</b>	<b>2.270</b>	<b>2.732</b>			
H. 2580	EMAC4280	<b>2.287</b>	<b>2.287</b>	<b>2.287</b>	<b>2.715</b>			

CODICE	lacc. opaco base	lacc. opaco colore	essenza	rovere lacc. poro aperto	rovere termotrattato	lacc. lucido		Maggiorazione per interno laccato opaco
CODE	basic matt lacq.	colour matt lacq.	wood	open pore lacq. oak	heat-treated oak	glossy lacq.		Increase for matt lacquered inside finish

FIANCO | SIDE PANEL

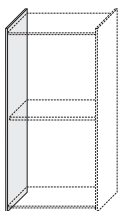

P. | D. 585

H. 2356	EMF19523	<b>115</b>	<b>129</b>	<b>162</b>	<b>206</b>	<b>200</b>	<b>205</b>	<b>44</b>
H. 2580	EMF19524	<b>124</b>	<b>137</b>	<b>174</b>	<b>222</b>	<b>213</b>	<b>221</b>	<b>48</b>

# COMPLANARE | FLUSH-FITTING

## abaco anta composta complanare | flush-fitting composta door list

- Prezzo già comprensivo di maniglie Vip. Maggiorazione per maniglia laccato opaco colore di **12 euro cad.**
- Price includes Vip handles. Increase for matt lacquered handle euro **12 each.**
- Possibilità di gestire e comporre ognuno dei **3 pannelli con una finitura diversa in base ai propri gusti. Il pannello centrale inoltre è disponibile anche con incisioni (motivo ad onda) su pannello rovere poro aperto.**
- Possibility to manage and compose each of the **3 panels with a different finish according to personal taste. The middle panel is also available with engravings (wave design) on open pore oak.**

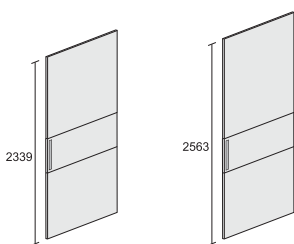

Il prezzo per l'anta composta complanare si ottiene sommando il prezzo del: pannello inferiore **(1)** + pannello centrale **(2)** + pannello superiore **(3)** o **(4)** a seconda dell'altezza dell'anta.

Price for flush-fitting door is obtained by adding the price of: lower panel **(1)** + middle panel **(2)** + upper panel **(3)** or **(4)** depending on door height.

CODICE	lacc. opaco base	lacc. opaco colore	essenza	rovere lacc. poro aperto	rovere termotrattato	lacc. lucido		rovere lacc. poro aperto incisione ONDA
CODE	basic matt lacq.	colour matt lacq.	wood	open pore lacq. oak	heat-treated oak	glossy lacq.		open pore lacq. oak wave engraving

### COMPOSTA PANN. 1 H.2339 - 2563

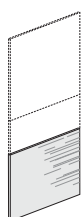

L. 1247	EMA97355	<b>240</b>	<b>256</b>	<b>273</b>	<b>334</b>	<b>325</b>	<b>331</b>	
L. 1447	EMA97365	<b>260</b>	<b>278</b>	<b>293</b>	<b>366</b>	<b>356</b>	<b>365</b>	

### COMPOSTA PANN. 2 H.2339 - 2563

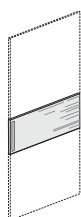

L. 1247	EMA98354	<b>205</b>	<b>214</b>	<b>223</b>	<b>254</b>	<b>248</b>	<b>251</b>	<b>290</b>
L. 1447	EMA98364	<b>217</b>	<b>227</b>	<b>236</b>	<b>272</b>	<b>266</b>	<b>271</b>	<b>309</b>

### COMPOSTA PANN. 3 H.2339

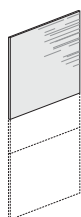

L. 1247	EMA99357	<b>282</b>	<b>300</b>	<b>325</b>	<b>391</b>	<b>382</b>	<b>391</b>	
L. 1447	EMA99367	<b>307</b>	<b>328</b>	<b>352</b>	<b>431</b>	<b>420</b>	<b>433</b>	

### COMPOSTA PANN. 4 H.2563

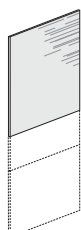

L. 1247	EMA99358	<b>300</b>	<b>323</b>	<b>350</b>	<b>435</b>	<b>423</b>	<b>433</b>	
L. 1447	EMA99368	<b>327</b>	<b>354</b>	<b>381</b>	<b>480</b>	<b>467</b>	<b>480</b>	

# COMPLANARE | FLUSH-FITTING

## abaco anta composta plus complanare | flush-fitting composta plus door list

- Possibilità di gestire e comporre ognuno dei 3 pannelli con una finitura diversa in base ai propri gusti. Il pannello centrale inoltre è disponibile anche con incisioni (motivo ad onda) su pannello rovere poro aperto.

- Possibility to manage and compose each of the 3 panels with a different finish according to personal taste. The middle panel is also available with engravings (wave design) on open pore oak.

- La maniglia è già inserita su pannello centrale. Disponibile nelle finiture laccato opaco o lucido, rovere lacc. poro aperto, rovere moro, rovere tabacco, rovere nodi o rovere termotrattato.

- The handle is built-in the central panel. Available in matt or glossy lacquer, open-pore lacquered oak, oak in mahogany or tobacco finish, oak knots or heat-treated oak.

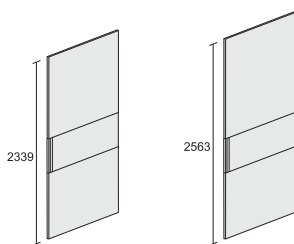

Il prezzo per l'anta composta complanare plus si ottiene sommando il prezzo del: pannello inferiore (1) + pannello centrale (2) + pannello superiore (3) o (4) a seconda dell'altezza dell'anta.

Price for flush-fitting plus door is obtained by adding the price of: lower panel (1) + middle panel (2) + upper panel (3) or (4) depending on door height.

CODICE	lacc. opaco base	lacc. opaco colore	essenza	rovere lacc. poro aperto	rovere termotrattato	lacc. lucido		rovere lacc. poro aperto incisione ONDA
CODE	basic matt lacq.	colour matt lacq.	wood	open pore lacq. oak	heat-treated oak	glossy lacq.		open pore lacq. oak wave engraving

### COMPOSTA PLUS PANN. 1 H. 2339 - 2563

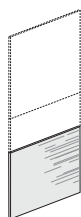

L. 1247	EMA97355	240	256	273	334	325	331	
L. 1447	EMA97365	260	278	293	366	356	365	

### COMPOSTA PLUS PANN. 2 H. 2339 - 2563

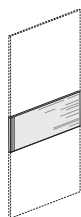

L. 1247	EMA98355	205	214	223	254	248	251	290
L. 1447	EMA98365	217	227	236	272	266	271	309

### COMPOSTA PLUS PANN. 3 H. 2339



L. 1247	EMA99357	282	300	325	391	382	391	
L. 1447	EMA99367	307	328	352	431	420	433	

### COMPOSTA PLUS PANN. 4 H. 2563

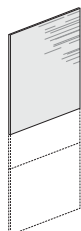

L. 1247	EMA99358	300	323	350	435	423	433	
L. 1447	EMA99368	327	354	381	480	467	480	

# COMPLANARE | FLUSH-FITTING

## abaco anta green | flush-fitting green door list

- Possibilità di gestire e comporre ognuno dei 3 pannelli con una finitura diversa in base ai propri gusti.

- Possibility to manage and compose each of the 3 panels with a different finish according to personal taste.

- Nell'anta GREEN la maniglia è inserita su pannello inferiore. Disponibile nelle finiture laccato opaco o lucido, rovere nodi o rovere termotrattato, rovere laccato poro aperto.

- The door GREEN is supplied with a handle built-in the lower panel. Available in matt or glossy lacquer, oak knots or heat-treated oak finish, lacq. open pore oak.

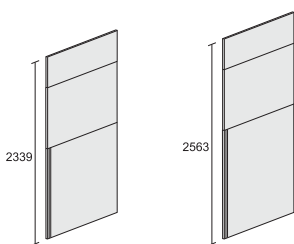



Il prezzo per l'anta green complanare si ottiene sommando il prezzo del: pannello inferiore (1) + pannello centrale (2) + pannello superiore (3) o (4) a seconda dell'altezza dell'anta.

Price for flush-fitting door is obtained by adding the price of: lower panel (1) + middle panel (2) + upper panel (3) or (4) depending on door height.

CODICE	lacc. opaco base	lacc. opaco colore	essenza	rovere lacc. poro aperto	rovere termotrattato	lacc. lucido			
CODE	basic matt lacq.	colour matt lacq.	wood	open pore lacq. oak	heat-treated oak	glossy lacq.			
<b>GREEN PANN. 1</b> H. 2339 - 2563									
L. 1247	EMAG6354	<b>179</b>	<b>188</b>	<b>197</b>	<b>228</b>	<b>222</b>	<b>225</b>		
L. 1447	EMAG6364	<b>191</b>	<b>201</b>	<b>210</b>	<b>246</b>	<b>240</b>	<b>245</b>		
<b>GREEN PANN. 2</b> H. 2339 - 2563									
L. 1247	EMAG5355	<b>240</b>	<b>256</b>	<b>273</b>	<b>334</b>	<b>325</b>	<b>331</b>		
L. 1447	EMAG5365	<b>260</b>	<b>278</b>	<b>293</b>	<b>366</b>	<b>356</b>	<b>365</b>		
<b>GREEN PANN. 3</b> H. 2339									
L. 1247	EMAG4357	<b>368</b>	<b>386</b>	<b>411</b>	<b>477</b>	<b>468</b>	<b>477</b>		
L. 1447	EMAG4367	<b>393</b>	<b>414</b>	<b>438</b>	<b>517</b>	<b>506</b>	<b>519</b>		
<b>GREEN PANN. 4</b> H. 2563									
L. 1247	EMAG4358	<b>386</b>	<b>409</b>	<b>436</b>	<b>521</b>	<b>509</b>	<b>519</b>		
L. 1447	EMAG4368	<b>413</b>	<b>440</b>	<b>467</b>	<b>566</b>	<b>553</b>	<b>566</b>		

# SCORREVOLE | SLIDING DOOR

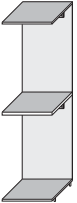
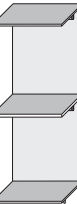
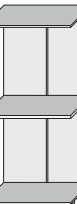
scocche vuote | empty bodies

<p>- Fianchi e divisioni a pag. 96 - Side panels and partitions on page 96</p> <p>- Ante da pag.   Doors starting from page 169</p> <p>- Dotazione interna vano standard: N. 1 ripiano - N. 2 tubi appendiabiti - Standard internal equipment: 1 shelf - 2 clothes hangers</p>	<p>CODICE</p> <p>CODE</p>	<p>melaminico magnolia</p> <p>magnolia melamine</p>	<p>melaminico decorativo tessuto</p> <p>decorative material melamine</p>	<p>melaminico rovere termotrattato</p> <p>heat-treated oak melamine</p>	<p>lacc. opaco</p> <p>matl lacq.</p>				
<p>EL. 1 ANTA da 740 mm - escluso di fianchi, divisioni e anta EL. 1 DOOR 740 mm - side panels, partitions and door not included</p>  <p><b>L.   W. 700</b></p>									
<p>EL. 1 ANTA da 1021 mm - escluso di fianchi, divisioni e anta EL. 1 DOOR 1021 mm - side panels, partitions and door not included</p>  <p><b>L.   W. 981</b></p>									
<p>EL. 1 ANTA da 1265 mm - escluso di fianchi, divisioni e anta EL. 1 DOOR 1265 mm - side panels, partitions and door not included</p>  <p><b>L.   W. 1225</b></p>									
<p>EL. 1 ANTA da 1465 mm - escluso di fianchi, divisioni e anta EL. 1 DOOR 1465 mm - side panels, partitions and door not included</p>  <p><b>L.   W. 1425</b></p>									



# SCORREVOLE | SLIDING DOOR

## abaco anta slide | slide door list

- Maniglie a pag. 89  
- Handles on page 89

CODICE	lacc. opaco base	lacc. opaco colore	essenza	rovere lacc. poro aperto	rovere termotrattato	lacc. lucido	vetro cat. 1	vetro cat. 2
CODE	basic matt lacq.	colour matt lacq.	wood	open pore lacq. oak	heat-treated oak	glossy lacq.	glass cat. 1	glass cat. 2

SLIDE L. 740 mm

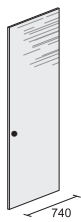

H. 2211	EMA30366	<b>239</b>	<b>278</b>	<b>350</b>	<b>446</b>	<b>396</b>	<b>457</b>		
H. 2339	EMA30367	<b>248</b>	<b>287</b>	<b>363</b>	<b>464</b>	<b>410</b>	<b>476</b>		
H. 2563	EMA30368	<b>261</b>	<b>303</b>	<b>386</b>	<b>494</b>	<b>436</b>	<b>508</b>		

SLIDE L. 1021 mm

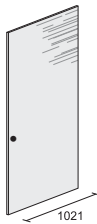

H. 2211	EMA30376	<b>326</b>	<b>378</b>	<b>443</b>	<b>568</b>	<b>501</b>	<b>624</b>		
H. 2339	EMA30377	<b>332</b>	<b>387</b>	<b>454</b>	<b>587</b>	<b>513</b>	<b>645</b>		
H. 2563	EMA30378	<b>359</b>	<b>419</b>	<b>488</b>	<b>632</b>	<b>554</b>	<b>699</b>		

SLIDE L. 1265 mm

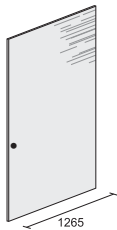

H. 2211	EMA30386	<b>373</b>	<b>434</b>	<b>514</b>	<b>668</b>	<b>578</b>	<b>729</b>		
H. 2339	EMA30387	<b>380</b>	<b>446</b>	<b>524</b>	<b>692</b>	<b>592</b>	<b>755</b>		
H. 2563	EMA30388	<b>411</b>	<b>482</b>	<b>562</b>	<b>747</b>	<b>641</b>	<b>819</b>		

# SCORREVOLE | SLIDING DOOR

abaco anta incisa e onda | *incisa and onda door list*

- Maniglie a pag. 89  
- Handles on page 89

CODICE	lacc. opaco base	lacc. opaco colore	essenza	rovere lacc. poro aperto	rovere termotrattato	lacc. lucido	vetro cat. 1	vetro cat. 2
CODE	basic matt lacq.	colour matt lacq.	wood	open pore lacq. oak	heat-treated oak	glossy lacq.	glass cat. 1	glass cat. 2

**INCISA** L. 1021 mm

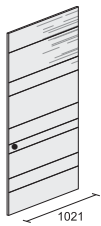

H. 2339	EMA32377			<b>648</b>				
H. 2563	EMA32378			<b>695</b>				

**INCISA** L. 1265 mm

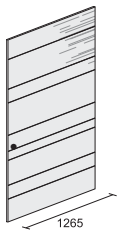

H. 2339	EMA32387			<b>757</b>				
H. 2563	EMA32388			<b>815</b>				

**ONDA** L. 1021 mm



H. 2339	EMA38377			<b>700</b>				
H. 2563	EMA38378			<b>746</b>				

**ONDA** L. 1265 mm





H. 2339	EMA38387			<b>809</b>				
H. 2563	EMA38388			<b>866</b>				

# SCORREVOLE | SLIDING DOOR

## abaco anta tecno | tecno door list

- Nell'anta TECNO la maniglia è inserita per tutta la lunghezza dell'anta: disponibile in finitura bianco, con maggiorazione di **35 euro** per la finitura brill spazzolato e laccato opaco colore (da specificare nell'ordine).

- TECNO door is supplied with a the handle built-in along the length of the door: available in white finish, with increase of **35 euros** for the brushed brill finish and colour matt lacquer (to be specified in the order).

	CODICE	lacc. opaco base	lacc. opaco colore	essenza	rovere lacc. poro aperto	rovere termotrattato	lacc. lucido	vetro cat.1	vetro cat.2
	CODE	basic matt lacq.	colour matt lacq.	wood	open pore lacq. oak	heat-treated oak	glossy lacq.	glass cat.1	glass cat.2
<b>TECNO</b> L. 740 mm									
	H. 2211	EMA33366	<b>282</b>	<b>323</b>	<b>399</b>	<b>487</b>	<b>443</b>	<b>506</b>	
	H. 2339	EMA33367	<b>288</b>	<b>331</b>	<b>410</b>	<b>504</b>	<b>457</b>	<b>523</b>	
	H. 2563	EMA33368	<b>304</b>	<b>349</b>	<b>436</b>	<b>535</b>	<b>488</b>	<b>557</b>	
<b>TECNO</b> L. 1021 mm									
	H. 2211	EMA33376	<b>359</b>	<b>410</b>	<b>488</b>	<b>616</b>	<b>546</b>	<b>672</b>	
	H. 2339	EMA33377	<b>365</b>	<b>419</b>	<b>499</b>	<b>635</b>	<b>558</b>	<b>692</b>	
	H. 2563	EMA33378	<b>393</b>	<b>451</b>	<b>540</b>	<b>670</b>	<b>601</b>	<b>731</b>	
<b>TECNO</b> L. 1265 mm									
	H. 2211	EMA33386	<b>411</b>	<b>472</b>	<b>558</b>	<b>702</b>	<b>621</b>	<b>766</b>	
	H. 2339	EMA33387	<b>419</b>	<b>483</b>	<b>565</b>	<b>726</b>	<b>635</b>	<b>789</b>	
	H. 2563	EMA33388	<b>452</b>	<b>521</b>	<b>623</b>	<b>786</b>	<b>691</b>	<b>854</b>	

# SCORREVOLE | SLIDING DOOR

## abaco anta telaio | frame door "O" list

**VETRI: cat. 1** sabbia chiaro, sabbia scuro, corda, grigio pietra, grigio chiaro, grigio medio, grigio polvere, blu piombo, giallo cromo, verde pompelmo, rosso rubino, nero, stopsol fumé, specchio, specchio bronzo, specchio fumo. **cat. 2** bianco, magnolia.

- Il telaio dell'anta permette la presa senza bisogno di maniglia.  
**Telaio in alluminio disponibile in finitura bianco, brill spazzolato e laccato opaco colore (da specificare nell'ordine).**  
 - The door frame allows the opening without the need of a handle. **Alluminium frame available in white finish, brushed brill finish and colour matt lacquer (to be specified in the order)**

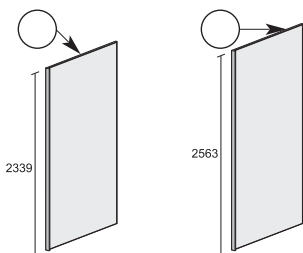

Il prezzo per l'anta telaio "O" si ottiene sommando il prezzo di:  
 un pannello (1) + telaio (3) per l'altezza 2339  
 un pannello (2) + telaio (4) per l'altezza 2563  
 Price for the "O" frame door is obtained by adding the price of:  
 a panel (1) + frame (3) by height 2339  
 a panel (2) + frame (4) by height 2563

CODICE	lacc. opaco base	lacc. opaco colore	essenza	rovere lacc. poro aperto	rovere termotrattato	lacc. lucido	vetro cat.1	vetro cat.2
CODE	basic matt lacq.	colour matt lacq.	wood	open pore lacq. oak	heat-treated oak	glossy lacq.	glass cat.1	glass cat.2

### "O" pannello | panel H. 2339

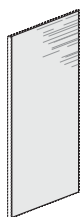

La larghezza 1465 è disponibile solo con vetro bianco o specchi.  
 Width 1465 is available only with white glass or mirrors.

L. 740	102	118	227	290		277	267	404
L. 1021	133	155	296	381		370	360	548
L. 1265	162	188	357	463		453	443	678
L. 1465							513	716

### "O" pannello | panel H. 2563



La larghezza 1465 è disponibile solo con vetro bianco o specchi.  
 Width 1465 is available only with white glass or mirrors.

L. 740	110	127	244	312		299	288	438
L. 1021	143	166	317	411		401	391	598
L. 1265	174	202	384	500		492	481	738
L. 1465							557	778

### "O" telaio | frame H. 2339



	lacc. opaco bianco white matt lacq.	lacc. opaco colore colour matt lacq.			brill spazzolato brushed brill		
L. 740	282	378			378		
L. 1021	297	393			393		
L. 1265	318	414			414		
L. 1465	334	430			430		

### "O" telaio | frame H. 2563



	lacc. opaco bianco white matt lacq.	lacc. opaco colore colour matt lacq.			brill spazzolato brushed brill		
L. 740	283	379			379		
L. 1021	299	395			395		
L. 1265	320	416			416		
L. 1465	336	432			432		

# SCORREVOLE | SLIDING DOOR

## abaco anta telaio | frame door "A" list

GLASSES: **cat. 1** light sand, dark sand, rope, stone grey, light grey, medium grey, powder grey, gun metal blue, chrome yellow, grapefruit green, ruby red, black, smoke-grey stapsol, mirror, bronze mirror, smoke mirror. **cat. 2** white, magnolia.

- Il telaio dell'anta permette la presa senza bisogno di maniglia.  
Telaio in alluminio disponibile in finitura bianco, brill spazzolato e laccato opaco colore (da specificare nell'ordine).
- The door frame allows the opening without the need of a handle. Alluminium frame available in white finish, brushed brill finish and colour matt lacquer (to be specified in the order).
- Possibilità di gestire e comporre ognuno dei 2 pannelli con una finitura diversa in base ai propri gusti.
- Possibility to manage and compose each of the 2 panels with a different finish according to personal taste.

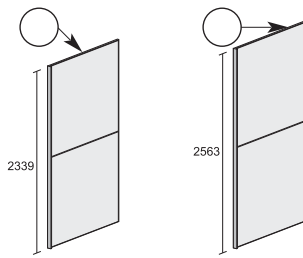

Il prezzo per l'anta telaio "A" si ottiene sommando il prezzo di:  
due pannelli (1) + telaio (3) per l'altezza 2339  
due pannelli (2) + telaio (4) per l'altezza 2563  
Price for the "A" frame door is obtained by adding the price of:  
two panels (1) + frame (3) by height 2339  
two panels (2) + frame (4) by height 2563

CODICE	lacc. opaco base	lacc. opaco colore	essenza	rovere lacc. poro aperto	rovere termotrattato	lacc. lucido	vetro cat.1	vetro cat.2
CODE	basic matt lacq.	colour matt lacq.	wood	open pore lacq. oak	heat-treated oak	glossy lacq.	glass cat.1	glass cat.2

"A" pannello sup.-inf. | upp.-low. panel H. 2339

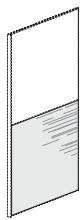

Sommare due volte il prezzo del pannello nelle finiture scelte  
Add twice the price of the panel in the chosen finishes

L. 740	57	68	119	151		143	137	206
L. 1021	74	88	156	198		193	183	279
L. 1265	90	107	187	239		234	225	344
L. 1465	102	122	212	274		269	262	399

"A" pannello sup.-inf. | upp.-low. panel H. 2563

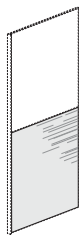

Sommare due volte il prezzo del pannello nelle finiture scelte  
Add twice the price of the panel in the chosen finishes

L. 740	61	72	128	162		155	149	224
L. 1021	80	95	166	213		207	198	303
L. 1265	96	115	200	258		253	244	374
L. 1465	110	131	228	296		292	284	434

"A" telaio | frame H. 2339

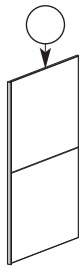

lacc. opaco bianco  
white matt lacq.

lacc. opaco colore  
colour matt lacq.

brill spazzolato  
brushed brill

L. 740	279	382				382		
L. 1021	293	396				396		
L. 1265	314	417				417		
L. 1465	328	431				431		

"A" telaio | frame H. 2563

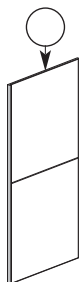

lacc. opaco bianco  
white matt lacq.

lacc. opaco colore  
colour matt lacq.

brill spazzolato  
brushed brill

L. 740	280	383				383		
L. 1021	295	398				398		
L. 1265	315	418				418		
L. 1465	330	433				433		

# SCORREVOLE | SLIDING DOOR

## abaco anta telaio | frame door "C" list H. 2339

**VETRI: cat. 1** sabbia chiaro, sabbia scuro, corda, grigio pietra, grigio chiaro, grigio medio, grigio polvere, blu piombo, giallo cromo, verde pompelmo, rosso rubino, nero, stopsol fumé, specchio, specchio bronzo, specchio fumo. **cat. 2** bianco, magnolia.

- Il telaio dell'anta permette la presa senza bisogno di maniglia.
- Telaio in alluminio disponibile in finitura bianco, brill spazzolato e laccato opaco colore (da specificare nell'ordine).
- The door frame allows the opening without the need of a handle. Aluminium frame available in white finish, brushed brill finish and colour matt lacquer (to be specified in the order).
- Possibilità di gestire e comporre ognuno dei 3 pannelli con una finitura diversa in base ai propri gusti.
- Possibility to manage and compose each of the 3 panels with a different finish according to personal taste.

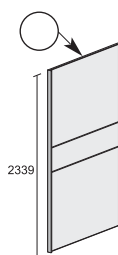

Il prezzo per l'anta telaio "C" H. 2339 si ottiene sommando il prezzo di: due pannelli (1) + un pannello centrale (2) + telaio (3)  
Price for the "C" frame door H. 2339 is obtained by adding the price of: two panels (1) + a middle panel (2) + frame (3)

CODICE	lacc. opaco base	lacc. opaco colore	essenza	rovere lacc. poro aperto	rovere termotrattato	lacc. lucido	vetro cat.1	vetro cat.2
CODE	basic matt lacq.	colour matt lacq.	wood	open pore lacq. oak	heat-treated oak	glossy lacq.	glass cat.1	glass cat.2

### "C" pannello sup.-inf. | upp.-low. panel H. 2339

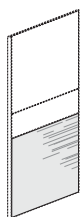

Sommare due volte il prezzo del pannello nelle finiture scelte  
Add twice the price of the panel in the chosen finishes

L. 740	52	61	109	135		127	122	181
L. 1021	68	80	140	176		170	162	244
L. 1265	81	97	167	213		207	198	300
L. 1465	93	111	190	243		238	231	348

### "C" pannello cen. | mid. panel H. 2339

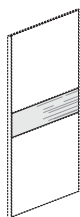

L. 740	14	17	35	43		38	32	50
L. 1021	19	23	44	56		51	43	68
L. 1265	23	27	53	68		63	53	84
L. 1465	26	32	59	76		72	61	98

### "C" telaio | frame H. 2339

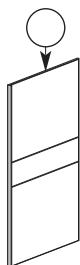

	lacc. opaco bianco white matt lacq.	lacc. opaco colore colour matt lacq.				brill spazzolato brushed brill		
L. 740	301	412				412		
L. 1021	319	430				430		
L. 1265	344	455				455		
L. 1465	361	472				472		

# SCORREVOLE | SLIDING DOOR

## abaco anta telaio | frame door "C" list H. 2563

GLASSES: **cat. 1** light sand, dark sand, rope, stone grey, light grey, medium grey, powder grey, gun metal blue, chrome yellow, grapefruit green, ruby red, black, smoke-grey stopsol, mirror, bronze mirror, smoke mirror. **cat. 2** white, magnolia.

- Il telaio dell'anta permette la presa senza bisogno di maniglia.  
Telaio in alluminio disponibile in finitura bianco, brill spazzolato e laccato opaco colore (da specificare nell'ordine).
- The door frame allows the opening without the need of a handle. Aluminium frame available in white finish, brushed brill finish and colour matt lacquer (to be specified in the order).
- Possibilità di gestire e comporre ognuno dei 3 pannelli con una finitura diversa in base ai propri gusti.
- Possibility to manage and compose each of the 3 panels with a different finish according to personal taste.

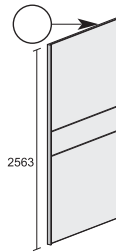

Il prezzo per l'anta telaio "C" H. 2563 si ottiene sommando il prezzo di: due pannelli (4) + un pannello centrale (2) + telaio (5)  
Price for the "C" frame door H. 2563 is obtained by adding the price of: two panels (4) + a middle panel (2) + frame (5)

CODICE	lacc. opaco base	lacc. opaco colore	essenza	rovere lacc. poro aperto	rovere termotrattato	lacc. lucido	vetro cat.1	vetro cat.2
CODE	basic matt lacq.	colour matt lacq.	wood	open pore lacq. oak	heat-treated oak	glossy lacq.	glass cat.1	glass cat.2

"C" pannello sup.-inf. | upp.-low. panel H. 2563

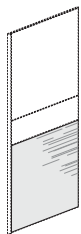

L. 740	56	66	116	146		139	133	198
L. 1021	72	86	150	192		185	177	268
L. 1265	87	104	180	232		226	217	330
L. 1465	100	119	206	265		261	252	382

"C" pannello cen. | mid. panel H. 2563

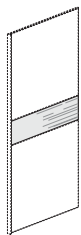

L. 740	14	17	35	43		38	32	50
L. 1021	19	23	44	56		51	43	68
L. 1265	23	27	53	68		63	53	84
L. 1465	26	32	59	76		72	61	98

"C" telaio | frame H. 2563

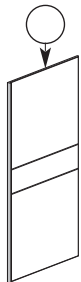

	lacc. opaco bianco white matt lacq.	lacc. opaco colore colour matt lacq.				brill spazzolato brushed brill		
L. 740	303	414				414		
L. 1021	321	432				432		
L. 1265	346	457				457		
L. 1465	363	474				474		

# SCORREVOLE | SLIDING DOOR

## abaco anta telaio | frame door "D" list

VETRI: cat. 1 sabbia chiaro, sabbia scuro, corda, grigio pietra, grigio chiaro, grigio medio, grigio polvere, blu piombo, giallo cromo, verde pompelmo, rosso rubino, nero, stopsol fumé, specchio, specchio bronzo, specchio fumo. cat. 2 bianco, magnolia.

- Il telaio dell'anta permette la presa senza bisogno di maniglia.

Telaio in alluminio disponibile in finitura bianco, brill spazzolato e laccato opaco colore (da specificare nell'ordine).

- The door frame allows the opening without the need of a handle. Aluminium frame available in white finish, brushed brill finish and colour matt lacquer (to be specified in the order).

- Possibilità di gestire e comporre ognuno dei 6 pannelli con una finitura diversa in base ai propri gusti.

- Possibility to manage and compose each of the 6 panels with a different finish according to personal taste.

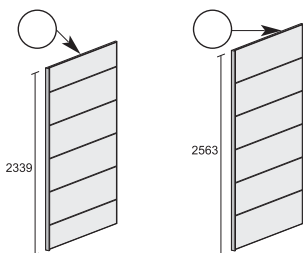

Il prezzo per l'anta telaio "D" si ottiene sommando il prezzo di: due pannelli (1) + quattro pannelli (2) + telaio (3) per l'altezza 2339 sei pannelli (2) + telaio (4) per l'altezza 2563

Price for the "D" frame door is obtained by adding the price of: two panels (1) + four panels (2) + frame (3) by height 2339 six panels (2) + frame (4) by height 2563

CODICE	lacc. opaco base	lacc. opaco colore	essenza	rovere lacc. poro aperto	rovere termotrattato	lacc. lucido	vetro cat.1	vetro cat.2
CODE	basic matt lacq.	colour matt lacq.	wood	open pore lacq. oak	heat-treated oak	glossy lacq.	glass cat.1	glass cat.2

### "D" pannello piccolo | small panel H. 2339



Sommare due volte il prezzo del pannello nelle finiture scelte per ante H. 2339 e sei volte per quella H. 2563  
Add twice the price of the panel in the chosen finishes for doors H. 2339 and six times for door H. 2563

L. 740	14	17	35	43		38	32	50
L. 1021	19	23	44	56		51	43	68
L. 1265	23	27	53	68		63	53	84
L. 1465	26	32	59	76		72	61	98

### "D" pannello grande | big panel H. 2339 - 2563



Sommare quattro volte il prezzo del pannello nelle finiture scelte per ante H. 2339 e sei volte per quella H. 2563  
Add four times the price of the panel in the chosen finishes for door H. 2339 and six times for door H. 2563

L. 740	18	21	42	54		49	42	67
L. 1021	23	28	55	70		66	58	93
L. 1265	28	35	66	85		81	72	115
L. 1465	33	39	74	97		93	83	133

### "D" telaio | frame H. 2339



	lacc. opaco bianco white matt lacq.	lacc. opaco colore colour matt lacq.			brill spazzolato brushed brill		
L. 740	381	513			513		
L. 1021	411	543			543		
L. 1265	448	580			580		
L. 1465	471	603			603		

### "D" telaio | frame H. 2563



	lacc. opaco bianco white matt lacq.	lacc. opaco colore colour matt lacq.			brill spazzolato brushed brill		
L. 740	384	516			516		
L. 1021	414	546			546		
L. 1265	450	582			582		
L. 1465	472	604			604		



# SCORREVOLE | SLIDING DOOR

## abaco anta composta | composta door list

GLASSES: **cat. 1** light sand, dark sand, rope, stone grey, light grey, medium grey, powder grey, gun metal blue, chrome yellow, grapefruit green, ruby red, black, smoke-grey stapsol, mirror, bronze mirror, smoke mirror. **cat. 2** white, magnolia.

- Disponibile solo con maniglia Epsilon o Vip, prezzi a pag. 89  
- Available only with Epsilon or Vip handle, prices on p. 89

- Possibilità di gestire e comporre ognuno dei 3 pannelli con una finitura diversa in base ai propri gusti. Il pannello centrale inoltre è disponibile anche con incisioni (motivo ad onda) su pannello rovere poro aperto.

- Possibility to manage and compose each of the 3 panels with a different finish according to personal taste. The middle panel is also available with engravings (wave design) on open pore oak.

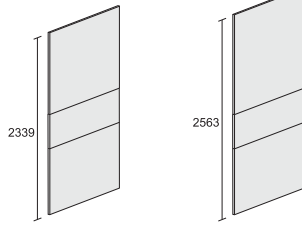

Il prezzo per l'anta composta si ottiene sommando il prezzo del pannello inferiore (1) + pannello centrale (2) + pannello superiore (3) o (4) a seconda dell'altezza dell'anta.

Price for composta door is obtained by adding the price of: lower panel (1) + middle panel (2) + upper panel (3) or (4) depending on door height.

CODICE	lacc. opaco base	lacc. opaco colore	essenza	rovere lacc. poro aperto	rovere termotrattato	lacc. lucido		rovere lacc. poro aperto incisione ONDA
CODE	basic matt lacq.	colour matt lacq.	wood	open pore lacq. oak	heat-treated oak	glossy lacq.		open pore lacq. oak wave engraving

### COMPOSTA PANN. 1 H. 2339 - 2563

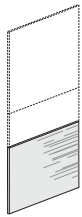

L. 1021	EMA94345	190	203	219	267	259	264	
L. 1265	EMA94355	213	229	246	307	298	304	
L. 1465	EMA94365	233	251	266	339	329	338	

### COMPOSTA PANN. 2 H. 2339 - 2563

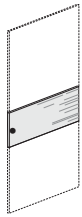

L. 1021	EMA95344	140	146	155	179	176	176	214
L. 1265	EMA95354	152	161	170	201	195	198	237
L. 1465	EMA95364	164	174	183	219	213	218	256

### COMPOSTA PANN. 3 H. 2339

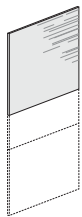

L. 1021	EMA96347	225	240	264	315	308	313	
L. 1265	EMA96357	255	273	298	364	355	364	
L. 1465	EMA96367	280	301	325	404	393	406	

### COMPOSTA PANN. 4 H. 2563

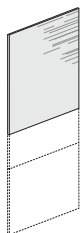

L. 1021	EMA96348	240	258	285	350	341	347	
L. 1265	EMA96358	273	296	323	408	396	406	
L. 1465	EMA96368	300	327	354	453	440	453	

# SCORREVOLE | SLIDING DOOR

## abaco anta composta plus | composta plus door list

VETRI: cat. 1 sabbia chiaro, sabbia scuro, corda, grigio pietra, grigio chiaro, grigio medio, grigio polvere, blu piombo, giallo cromo, verde pompelmo, rosso rubino, nero, stopsol fumé, specchio, specchio bronzo, specchio fumo. cat. 2 bianco, magnolia.

- Possibilità di gestire e comporre ognuno dei 3 pannelli con una finitura diversa in base ai propri gusti. Il pannello centrale inoltre è disponibile anche con incisioni (motivo onda) su pannello rovere poro aperto.
- Possibility to manage and compose each of the 3 panels with a different finish according to personal taste. The middle panel is also available with engravings (wave design) on open pore oak.
- La maniglia è già inserita su pannello centrale. Disponibile nelle finiture laccato opaco o lucido, rovere lacc. poro aperto, rovere moro, rovere tabacco, rovere nodi o rovere termotrattato.
- The handle is built-in along the central panel. Available in matt or glossy lacquer, open-pore lacquered oak, oak in mahogany or tobacco finish, oak knots or heat-treated oak.

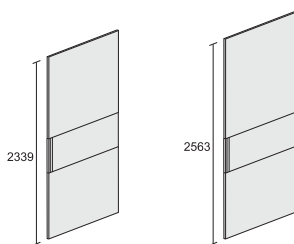

Il prezzo per l'anta composta plus si ottiene sommando il prezzo del pannello inferiore (1) + pannello centrale (2) + pannello superiore (3) o (4) a seconda dell'altezza dell'anta.

Price for composta plus door is obtained by adding the price of: lower panel (1) + middle panel (2) + upper panel (3) or (4) depending on door height.

CODICE	lacc. opaco base	lacc. opaco colore	essenza	rovere lacc. poro aperto	rovere termotrattato	lacc. lucido		rovere lacc. poro aperto incisione ONDA
CODE	basic matt lacq.	colour matt lacq.	wood	open pore lacq. oak	heat-treated oak	glossy lacq.		open pore lacq. oak wave engraving

### COMPOSTA PLUS PANN. 1 H. 2339 - 2563

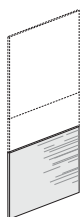

L. 1021	EMA94345	190	203	219	267	259	264	
L. 1265	EMA94355	213	229	246	307	298	304	
L. 1465	EMA94365	233	251	266	339	329	338	

### COMPOSTA PLUS PANN. 2 H. 2339 - 2563

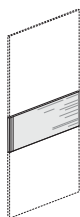

L. 1021	EMA95345	210	216	225	249	246	246	284
L. 1265	EMA95355	222	231	240	271	265	268	307
L. 1465	EMA95365	234	244	253	289	283	288	326

### COMPOSTA PLUS PANN. 3 H. 2339



L. 1021	EMA96347	225	240	264	315	308	313	
L. 1265	EMA96357	255	273	298	364	355	364	
L. 1465	EMA96367	280	301	325	404	393	406	

### COMPOSTA PLUS PANN. 4 H. 2563

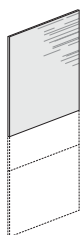

L. 1021	EMA96348	240	258	285	350	341	347	
L. 1265	EMA96358	273	296	323	408	396	406	
L. 1465	EMA96368	300	327	354	453	440	453	

# SCORREVOLE | SLIDING DOOR

## abaco anta green | green door list

GLASSES: cat. 1 light sand, dark sand, rope, stone grey, light grey, medium grey, powder grey, gun metal blue, chrome yellow, grapefruit green, ruby red, black, smoke-grey stapsol, mirror, bronze mirror, smoke mirror. cat. 2 white, magnolia.

- Possibilità di gestire e comporre ognuno dei 3 pannelli con una finitura diversa in base ai propri gusti.
- Possibility to manage and compose each of the 3 panels with a different finish according to personal taste.
- Nell'anta GREEN la maniglia è inserita su pannello inferiore. Disponibile nelle finiture laccato opaco o lucido, rovere nodi o rovere termotrattato, rovere laccato poro aperto, rovere moro, rovere tabacco.
- The door GREEN is supplied with a handle built-in the lower panel. Available in matt or glossy lacquer, oak knots or heat-treated oak finish, lacq. open pore, oak in mahogany-tobacco finish.

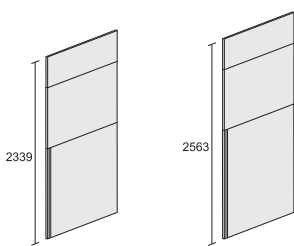

Il prezzo per l'anta green si ottiene sommando il prezzo del: pannello inferiore (1) + pannello centrale (2) + pannello superiore (3) o (4) a seconda dell'altezza dell'anta.

Price for green door is obtained by adding the price of: lower panel (1) + middle panel (2) + upper panel (3) or (4) depending on door height.

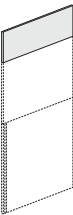
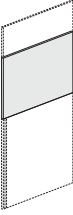
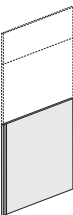
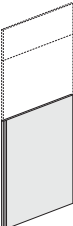
CODICE	lacc. opaco base	lacc. opaco colore	essenza	rovere lacc. poro aperto	rovere termotrattato	lacc. lucido		
CODE	basic matt lacq.	colour matt lacq.	wood	open pore lacq. oak	heat-treated oak	glossy lacq.		
<b>GREEN PANN. 1</b> H. 2339 - 2563								
								
L. 1021	EMAG3344	140	146	155	179	176	176	
L. 1265	EMAG3354	152	161	170	201	195	198	
L. 1465	EMAG3364	164	174	183	219	213	218	
<b>GREEN PANN. 2</b> H. 2339 - 2563								
								
L. 1021	EMAG2345	190	203	219	267	259	264	
L. 1265	EMAG2355	213	229	246	307	298	304	
L. 1465	EMAG2365	233	251	266	339	329	338	
<b>GREEN PANN. 3</b> H. 2339								
								
L. 1021	EMAG1347	311	326	350	401	394	399	
L. 1265	EMAG1357	341	359	384	450	441	450	
L. 1465	EMAG1367	366	387	411	490	479	492	
<b>GREEN PANN. 4</b> H. 2563								
								
L. 1021	EMAG1348	326	344	371	436	427	433	
L. 1265	EMAG1358	359	382	409	494	482	492	
L. 1465	EMAG1368	386	413	440	539	526	539	

# SCORREVOLE | SLIDING DOOR

## abaco anta vertical | vertical door list

NETTI: cat. 1 sabbia chiara, sabbia scura, corda, grigio pietra, grigio chiaro, grigio medio, grigio polvere, blu piombo, giallo cromo, verde pompelmo, rosso rubino, nero, stopsol fumé, specchio, specchio bronzo, specchio fumo. cat. 2 bianco, magnolia.

- Possibilità di gestire e comporre ognuno dei 2 pannelli con una finitura diversa in base ai propri gusti.

- Possibility to manage and compose each of the 2 panels with a different finish according to personal taste.

- Maniglie a pag. 89  
- Handles on page 89



Il prezzo per l'anta vertical si ottiene sommando il prezzo del pannello (1) a seconda dell'altezza dell'anta + pannello (2)  
Price for vertical door is obtained by adding the price of panel (1) depending on door height + panel (2)

CODICE	lacc. opaco base	lacc. opaco colore	essenza	rovere lacc. poro aperto	rovere termotrattato	lacc. lucido		
CODE	basic matt lacq.	colour matt lacq.	wood	open pore lacq. oak	heat-treated oak	glossy lacq.		

VERTICAL PANN. 1 L. 621 per anta L. 1021

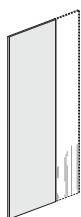

H. 2339	EMAV1357	<b>255</b>	<b>287</b>			<b>439</b>		
H. 2563	EMAV1358	<b>264</b>	<b>294</b>			<b>457</b>		

VERTICAL PANN. 1 L. 865 per anta L. 1265



H. 2339	EMAV1387	<b>304</b>	<b>345</b>			<b>549</b>		
H. 2563	EMAV1388	<b>315</b>	<b>353</b>			<b>573</b>		

VERTICAL PANN. 1 L. 1065 per anta L. 1421

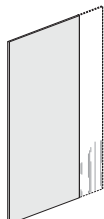

H. 2339	EMAV1397	<b>349</b>	<b>397</b>			<b>645</b>		
H. 2563	EMAV1398	<b>361</b>	<b>406</b>			<b>672</b>		

VERTICAL PANN. 2 L. 400

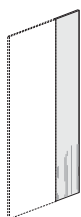

H. 2339	EMAV3347	<b>154</b>	<b>174</b>	<b>269</b>	<b>349</b>	<b>332</b>	<b>271</b>	
H. 2563	EMAV3348	<b>163</b>	<b>181</b>	<b>284</b>	<b>370</b>	<b>351</b>	<b>286</b>	

# SCORREVOLE | SLIDING DOOR

## abaco anta riga | riga door list

GLASSES: cat. 1 light sand, dark sand, rope, stone grey, light grey, medium grey, powder grey, gun metal blue, chrome yellow, grapefruit green, ruby red, black, smoke-grey stapsol, mirror, bronze mirror, smoke mirror. cat. 2 white, magnolia.

- Possibilità di gestire e comporre ognuno dei 2 pannelli con una finitura diversa in base ai propri gusti.
- Possibility to manage and compose each of the 2 panels with a different finish according to personal taste.
- La fascia centrale è disponibile nelle finiture laccato opaco - laccato lucido - rovere nodi - rovere termotrattato - rovere laccato poro aperto - rovere moro - rovere tabacco
- The central strip is available in matt-glossy lacquer finish or in oak knots or heat-treated oak finish - lacq. open pore oak, - oak in mahogany-tobacco finish.
- Maniglia: LAMA H. 40, vedi pag. 89
- Handle: LAMA H.40, see page 89

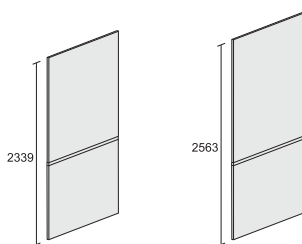

Il prezzo per l'anta riga si ottiene sommando il prezzo del pannello inferiore con fascia centrale (1) + pannello superiore (2) a seconda dell'altezza dell'anta.

Price for riga door is obtained by adding the price of lower panel with central strip (1) + upper panel (2) depending on door height.

CODICE	lacc. opaco base	lacc. opaco colore	essenza	rovere lacc. poro aperto	rovere termotrattato	lacc. lucido		
CODE	basic matt lacq.	colour matt lacq.	wood	open pore lacq. oak	heat-treated oak	glossy lacq.		

### RIGA PANN. 1 H. 1085

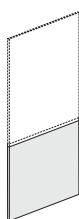

L. 1021	EMAR1345	<b>278</b>	<b>292</b>			<b>362</b>		
L. 1265	EMAR1355	<b>318</b>	<b>335</b>			<b>422</b>		

### RIGA PANN. 2 H. 1254

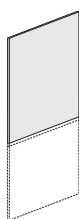

L. 1021	EMAR2347	<b>251</b>	<b>267</b>			<b>359</b>		
L. 1265	EMAR2357	<b>283</b>	<b>304</b>			<b>418</b>		

### RIGA PANN. 3 H. 1478

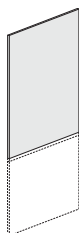

L. 1021	EMAR2348	<b>265</b>	<b>285</b>			<b>393</b>		
L. 1265	EMAR2358	<b>300</b>	<b>325</b>			<b>458</b>		

# SCORREVOLE | SLIDING DOOR

## composizioni fotografiche | photo compositions

DOTAZIONE INTERNA VANO STANDARD: N. 1 ripiano, N. 2 tubi appendiabiti | STANDARD INTERNAL EQUIPMENT: 1 shelf, 2 clothes hangers

### COMPOSIZIONE | COMPOSITION 1

L. 4049 H. 2580 P. | D. 659

**€ 4.562,00** prezzo: esterno come foto; interno con dotazione standard  
*price: outside as per photo; inside as per standard equipment*

- ANTE SLIDE  
- SLIDE DOORS
  - FIANCHI  
- SIDES
  - STRUTTURA INTERNA  
- INTERNAL STRUCTURE
  - MANIGLIA EPSILON  
- EPSILON HANDLE
- laccato opaco light grey y18231  
- matt lacquer light grey y18231
  - laccato opaco light grey y18231  
- matt lacquer light grey y18231
  - laccato opaco light grey y18231  
- matt lacquer light grey y18231
  - cromata  
- chromed

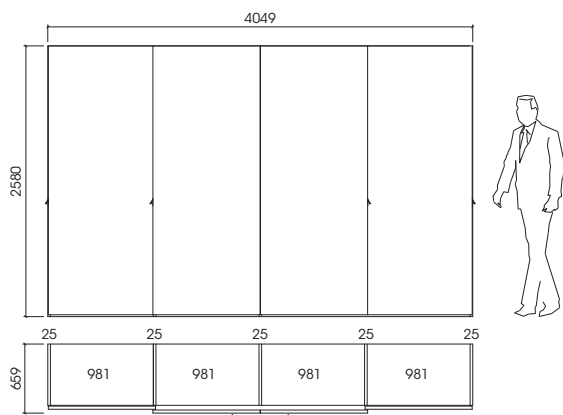

### COMPOSIZIONE | COMPOSITION 2

L. 3043 H. 2580 P. | D. 659

**€ 3.605,00** prezzo: esterno come foto; interno con dotazione standard  
*price: outside as per photo; inside as per standard equipment*

- ANTE TECNO  
- TECNO DOORS
  - FIANCHI  
- SIDES
  - STRUTTURA INTERNA  
- INTERNAL STRUCTURE
  - MANIGLIA TECNO  
- TECNO HANDLE
- laccato opaco dark grey y18232  
- matt lacquer dark grey y18232
  - laccato opaco dark grey y18232  
- matt lacquer dark grey y18232
  - laccato opaco light grey y18231  
- matt lacquer light grey y18231
  - lacc. opaca dark light y18231 (già inserita nell'anta)  
- matt lacquer light grey y18231 (already included in the door)

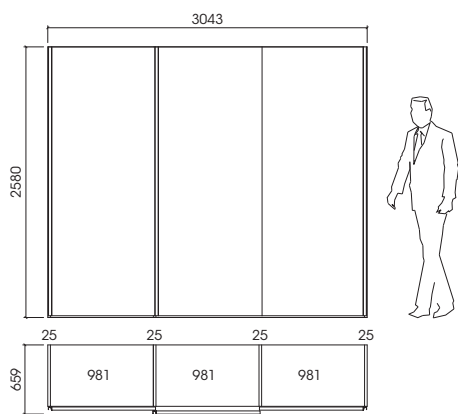

### COMPOSIZIONE | COMPOSITION 3

L. 3775 H. 2580 P. | D. 659

**€ 4.016,00** prezzo: esterno come foto; interno con dotazione standard  
*price: outside as per photo; inside as per standard equipment*

- ANTE COMPOSTA  
- COMPOSTA DOORS
  - FIANCHI  
- SIDES
  - STRUTTURA INTERNA  
- INTERNAL STRUCTURE
  - MANIGLIA EPSILON  
- EPSILON HANDLE
- lacc. op. dark grey y18232 - fascia centrale rovere termotrattato  
- matt lacquer dark grey y18232-central strip in heat-treated oak
  - laccato opaco dark grey y18232  
- matt lacquer dark grey y18232
  - melaminico  
- melamine
  - cromata  
- chromed

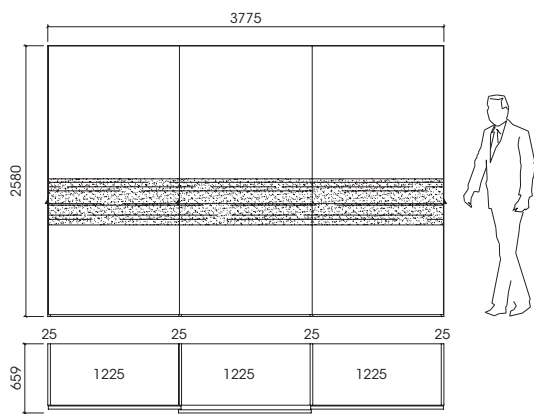

# SCORREVOLE | SLIDING DOOR

## composizioni fotografiche | photo compositions

**DOTAZIONE INTERNA VANO STANDARD: N. 1 ripiano, N. 2 tubi appendiabiti** | **STANDARD INTERNAL EQUIPMENT: 1 shelf, 2 clothes hangers**

### COMPOSIZIONE | COMPOSITION 4

L. 2925 H. 2580 P. | D. 622

**€ 4.961,00** prezzo: esterno come foto; interno con dotazione standard  
*price: outside as per photo; inside as per standard equipment*

- ANTE COMPOSTA COMPLANARE - laccato lucido bianco 9003
- FLUSH-FITTING COMPOSTA DOORS - glossy lacquer white 9003
- FIANCHI - laccato lucido bianco 9003
- SIDES - glossy lacquer white 9003
- STRUTTURA INTERNA - melaminico
- INTERNAL STRUCTURE - melamine
- MANIGLIA VIP - opaco bianco
- VIP HANDLE - matt white

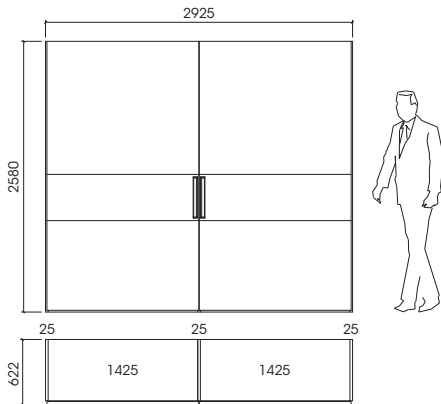

### COMPOSIZIONE | COMPOSITION 5

L. 2525 H. 2580 P. | D. 659

**€ 2.773,00** prezzo: esterno come foto; interno con dotazione standard  
*price: outside as per photo; inside as per standard equipment*

- ANTE COMPOSTA PLUS - lacc. op. light grey y18231 - maniglia su anta in rovere termotrattato
- COMPOSTA PLUS DOORS - matt lacquer light grey y18231 - handle in heat-treated oak
- FIANCHI - laccato opaco light grey y18231
- SIDES - matt lacquer light grey y18231
- STRUTTURA INTERNA - melaminico
- INTERNAL STRUCTURE - melamine

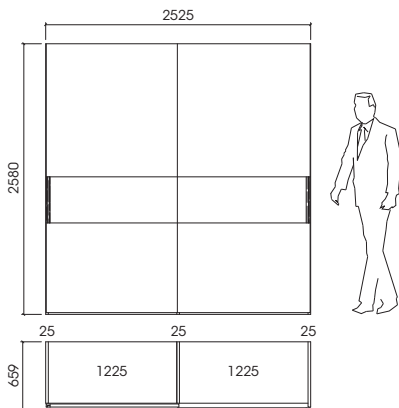

### COMPOSIZIONE | COMPOSITION 6

L. 2925 H. 2580 P. | D. 659

**€ 2.879,00** prezzo: esterno come foto; interno con dotazione standard  
*price: outside as per photo; inside as per standard equipment*

- ANTE GREEN - lacc. op. bianco 9003 - maniglia su anta in rovere termotrattato
- GREEN DOORS - matt lacquer white 9003 - handle in heat-treated oak
- FIANCHI - laccato opaco bianco 9003
- SIDES - matt lacquer white 9003
- STRUTTURA INTERNA - melaminico
- INTERNAL STRUCTURE - melamine

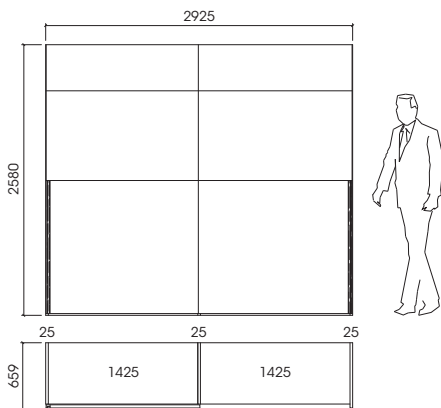

# SCORREVOLE | SLIDING DOOR

## composizioni fotografiche | photo compositions

DOTAZIONE INTERNA VANO STANDARD: N. 1 ripiano, N. 2 tubi appendiabiti | STANDARD INTERNAL EQUIPMENT: 1 shelf, 2 clothes hangers

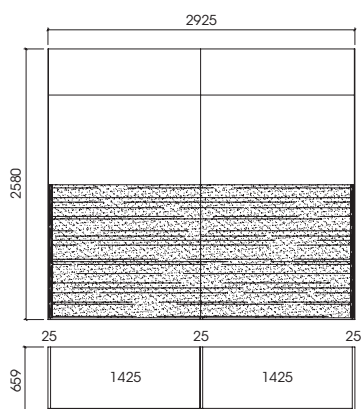

### COMPOSIZIONE | COMPOSITION 7

L. 2925 H. 2580 P. | D. 659

**€ 3.243,00** prezzo: esterno come foto; interno con dotazione standard  
*price: outside as per photo; inside as per standard equipment*

- |   |   |
|---|---|
| - ANTE GREEN<br>- GREEN DOORS               | - lacc. op. light grey y18231 e rovere termotrattato<br>- maniglia su anta in rovere termotrattato<br>- matt lacquer light grey y18231 and heat-treated oak<br>- handle in heat-treated oak |
| - FIANCHI<br>- SIDES                        | - laccato opaco light grey y18231<br>- matt lacquer light grey y18231   |
| - STRUTTURA INTERNA<br>- INTERNAL STRUCTURE | - melaminico<br>- melamine  |

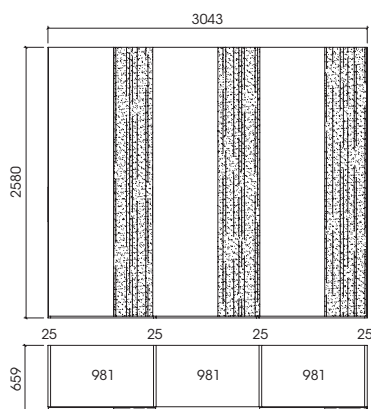

### COMPOSIZIONE | COMPOSITION 8

L. 3043 H. 2580 P. | D. 659

**€ 3.509,00** prezzo: esterno come foto; interno con dotazione standard  
*price: outside as per photo; inside as per standard equipment*

- |  |   |
|--|---|
| - ANTE VERTICAL<br>- VERTICAL DOORS            | - lacc. op. light grey y18231 e rovere termotrattato<br>- matt lacquer light grey y18231 and heat-treated oak |
| - FIANCHI<br>- SIDES                           | - laccato opaco light grey y18231<br>- matt lacquer light grey y18231   |
| - STRUTTURA INTERNA<br>- INTERNAL STRUCTURE    | - melaminico<br>- melamine  |
| - MANIGLIA LAMA H. 330<br>- LAMA HANDLE H. 330 | - laccato opaco light grey y18231<br>- matt lacquer light grey y18231   |

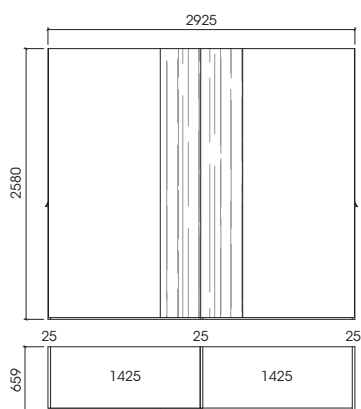

### COMPOSIZIONE | COMPOSITION 9

L. 2925 H. 2580 P. | D. 659

**€ 2.647,00** prezzo: esterno come foto; interno con dotazione standard  
*price: outside as per photo; inside as per standard equipment*

- |   |  |
|---|--|
| - ANTE VERTICAL<br>- VERTICAL DOORS         | - laccato opaco bianco 9003 e rovere nodi<br>- matt lacquer white 9003 and oak knots |
| - FIANCHI<br>- SIDES                        | - laccato opaco bianco 9003<br>- matt lacquer white 9003                             |
| - STRUTTURA INTERNA<br>- INTERNAL STRUCTURE | - melaminico<br>- melamine   |
| - MANIGLIA EPSILON<br>- EPSILON HANDLE      | - cromata<br>- chromed   |



# SCORREVOLE | SLIDING DOOR

## composizioni fotografiche | photo compositions

DOTAZIONE INTERNA VANO STANDARD: N. 1 ripiano, N. 2 tubi appendiabiti | STANDARD INTERNAL EQUIPMENT: 1 shelf, 2 clothes hangers

### COMPOSIZIONE | COMPOSITION 11

L. 3043 H. 2580 P. | D. 659

**€ 3.281,00** prezzo: esterno come foto; interno con dotazione standard  
*price: outside as per photo; inside as per standard equipment*

- |  |  |
|--|--|
| - ANTE RIGA<br>- RIGA DOORS                  | - lacc. op. canapa - fascia centrale lacc. op. corda<br>- matt lacquer hemp - central strip in matt lacquer rope |
| - FIANCHI<br>- SIDES                         | - laccato opaco canapa<br>- matt lacquer hemp  |
| - STRUTTURA INTERNA<br>- INTERNAL STRUCTURE  | - melaminico<br>- melamine   |
| - MANIGLIA LAMA H. 40<br>- LAMA HANDLE H. 40 | - laccato opaco corda<br>- matt lacquer rope   |

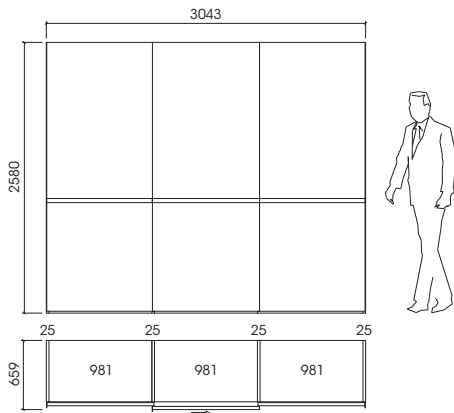

### COMPOSIZIONE | COMPOSITION 14

L. 2525 H. 2580 P. | D. 659

**€ 3.596,00** prezzo: esterno come foto; interno con dotazione standard  
*price: outside as per photo; inside as per standard equipment*

- |   |   |
|---|---|
| - ANTE "O"<br>- "O" DOORS                   | - vetro grigio chiaro<br>- light grey glass                         |
| - TELAIO ANTE<br>- FRAME DOORS              | - laccato opaco dark grey y18232<br>- matt lacquer dark grey y18232 |
| - FIANCHI<br>- SIDES                        | - laccato opaco dark grey y18232<br>- matt lacquer dark grey y18232 |
| - STRUTTURA INTERNA<br>- INTERNAL STRUCTURE | - laccato opaco dark grey y18232<br>- matt lacquer dark grey y18232 |

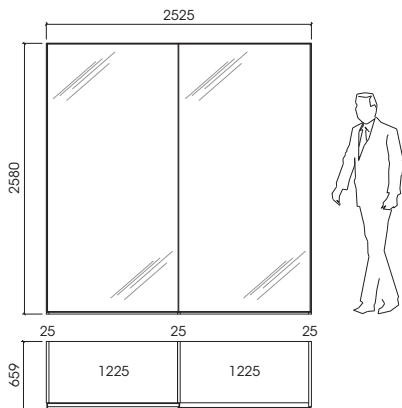

### COMPOSIZIONE | COMPOSITION 15

L. 3775 H. 2580 P. | D. 659

**€ 4.508,00** prezzo: esterno come foto; interno con dotazione standard  
*price: outside as per photo; inside as per standard equipment*

- |   |   |
|---|---|
| - ANTE "A"<br>- "A" DOORS                   | - vetro sabbia scuro<br>- dark sand glass                         |
| - TELAIO ANTE<br>- FRAME DOORS              | - laccato opaco grigio seta 7044<br>- matt lacquer silk grey 7044 |
| - FIANCHI<br>- SIDES                        | - laccato opaco grigio seta 7044<br>- matt lacquer silk grey 7044 |
| - STRUTTURA INTERNA<br>- INTERNAL STRUCTURE | - melaminico<br>- melamine  |

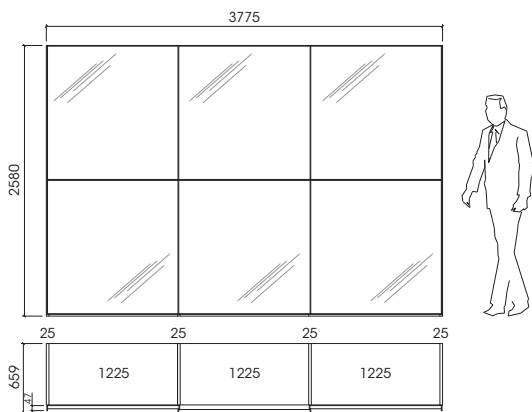

# SCORREVOLE | SLIDING DOOR

## composizioni fotografiche | photo compositions

DOTAZIONE INTERNA VANO STANDARD: N. 1 ripiano, N. 2 tubi appendiabiti | STANDARD INTERNAL EQUIPMENT: 1 shelf, 2 clothes hangers

### COMPOSIZIONE | COMPOSITION 16

L. 3043 H. 2580 P. | D. 659

**€ 3.919,00** prezzo: esterno come foto; interno con dotazione standard  
price: outside as per photo; inside as per standard equipment

- ANTE ONDA  
- ONDA DOORS

- rovere laccato opaco poro aperto bianco 9003  
- open pore lacquered oak white 9003

- FIANCHI  
- SIDES

- rovere laccato opaco poro aperto bianco 9003  
- open pore lacquered oak white 9003

- STRUTTURA INTERNA  
- INTERNAL STRUCTURE

- melaminico  
- melamine

- MANIGLIA EPSILON  
- EPSILON HANDLE

- cromata  
- chromed

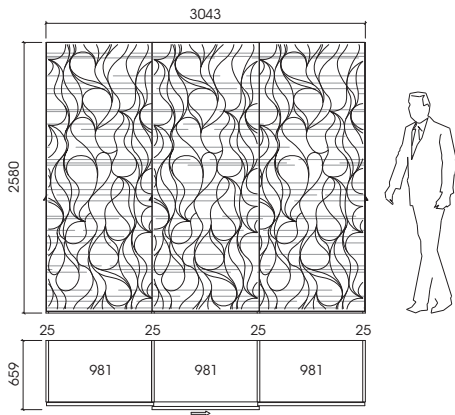



ATTREZZATURA INTERNA  
INTERNAL EQUIPMENT

# ATTREZZATURA INTERNA | OPTIONS

elementi per cassettiere interne | *elements for internal drawer units*

Esempi di composizione per cassettiere interne | *Examples of configuration for internal drawer units*



**MANIGLIA PER CASSETTIERE**  
finitura alluminio  
**HANDLE FOR INTERNAL DRAWERS**  
aluminium finish

Le guide impiegate nelle cassettiere sono ad estrazione parziale con chiusura ammortizzata. Portata massima per cassetto o cestone 20 kg distribuiti.

*The guides used in the internal drawers are partial pull-out with soft closing. Maximum load per internal drawer or basket 20 kg distributed.*

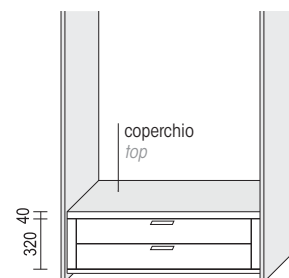

**ES. DI CASSETTIERA APPOGGIATA AL FONDO**  
*EX. OF INT. DRAWER UNIT RESTING ON BOTTOM*

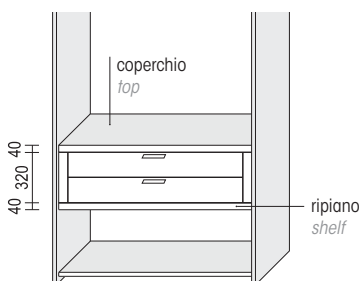

**ES. DI CASSETTIERA SOPRA RIPIANO**  
(massimo 2 cassetti)  
*EX. OF INTERNAL DRAWER UNIT ON SHELF*  
(max 2 drawers)

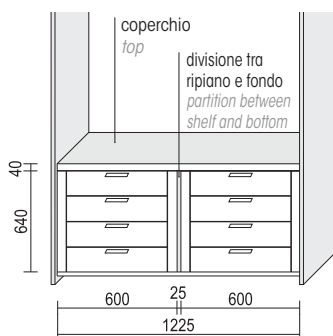

**ES. DI DUE CASSETTIERE AFFIANCATE**  
*EX. OF TWO PAIRED INTERNAL DRAWER UNITS*

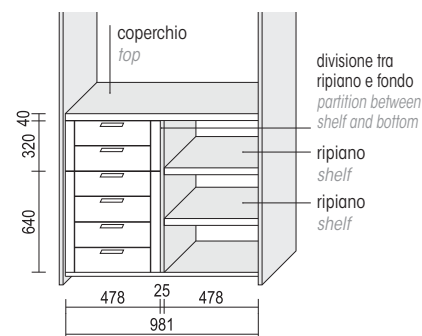

**ES. DI CASSETTIERA + RIPIANI LATERALI**  
*EX. OF INTERNAL DRAWER UNIT + SIDE SHELVES*

Descrizione <i>Description</i>	CODICE <i>CODE</i>	melaminico magnolia <i>magnolia melamine</i>	mel.decorativo tessuto <i>mel. decorative material</i>	mel. rovere termotrattato <i>mel. heat-treated oak</i>	lacc. opaco <i>matt lacq.</i>
COPERCHIO PER CASSETTIERA attenzione: aggiungere sempre il coperchio sopra la cassetiera TOP FOR INTERNAL DRAWER UNIT attention: always add the top on internal drawers	L. 478	EMXCC212	34	34	50
	L. 600	EMXCC222	38	38	58
	L. 700	EMXCC232	40	40	64
	L. 981	EMXCC242	53	53	86
	L. 1225	EMXCC252	66	66	106
	L. 1425	EMXCC262	74	74	119
DIVISIONE INTERNA tra ripiano e fondo, tagliata a misura modulare passo 160 INSIDE PARTITION between shelf and bottom, cut to modular size with step 160	EMD40525	105	105	105	146

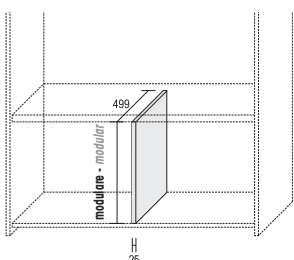



# ATTREZZATURA INTERNA | OPTIONS

## elementi per cassettiere interne | elements for internal drawer units

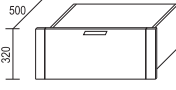
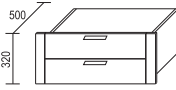
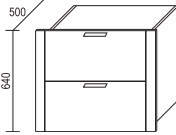
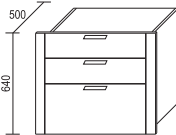
Descrizione <i>Description</i>	CODICE <i>CODE</i>	melaminico magnolia <i>magnolia melamine</i>	mel.decorativo tessuto <i>mel. decorative material</i>	mel. rovere termotrattato <i>mel. heat-treated oak</i>	lacc. opaco <i>mat lacq.</i>	
CASSETTIERA 1 cestone attenzione: aggiungere sempre il coperchio <i>INTERNAL DRAWER UNIT 1 deep drawer</i> <i>attention: always add the top</i>	L. 478	EMXC0212	130	130	130	151
	L. 600	EMXC0222	139	139	139	161
	L. 700	EMXC0232	144	144	144	168
	L. 981	EMXC0242	160	160	160	187
	L. 1225	EMXC0252	175	175	175	205
	L. 1425	EMXC0262	190	190	190	222
	 CASSETTIERA 2 cassetti attenzione: aggiungere sempre il coperchio <i>INTERNAL DRAWER UNIT 2 drawers</i> <i>attention: always add the top</i>	L. 478	EMXC1212	172	172	172
L. 600		EMXC1222	183	183	183	209
L. 700		EMXC1232	192	192	192	218
L. 981		EMXC1242	207	207	207	236
L. 1225		EMXC1252	225	225	225	258
L. 1425		EMXC1262	248	248	248	284
 CASSETTIERA 2 cassetti attenzione: aggiungere sempre il coperchio <i>INTERNAL DRAWER UNIT 2 deep drawers</i> <i>attention: always add the top</i>		L. 478	EMXC2214	194	194	194
	L. 600	EMXC2224	208	208	208	242
	L. 700	EMXC2234	214	214	214	252
	L. 981	EMXC2244	240	240	240	280
	L. 1225	EMXC2254	262	262	262	309
	L. 1425	EMXC2264	283	283	283	333
	 CASSETTIERA 2 cassetti e 1 cestone attenzione: aggiungere sempre il coperchio <i>INTERNAL DRAWER UNIT 2 drawers and 1 deep drawer</i> <i>attention: always add the top</i>	L. 478	EMXC3214	226	226	226
L. 600		EMXC3224	239	239	239	283
L. 700		EMXC3234	247	247	247	293
L. 981		EMXC3244	271	271	271	321
L. 1225		EMXC3254	296	296	296	355
L. 1425		EMXC3264	315	315	315	377
 CASSETTIERA 4 cassetti attenzione: aggiungere sempre il coperchio <i>INTERNAL DRAWER UNIT 4 drawers</i> <i>attention: always add the top</i>		L. 478	EMXC4214	288	288	288
	L. 600	EMXC4224	303	303	303	353
	L. 700	EMXC4234	313	313	313	365
	L. 981	EMXC4244	340	340	340	397
	L. 1225	EMXC4254	369	369	369	436
	L. 1425	EMXC4264	391	391	391	462

# ATTREZZATURA INTERNA | OPTIONS

## cassettiere interne | internal drawer units

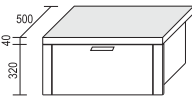
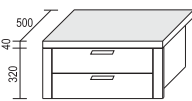
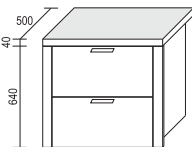
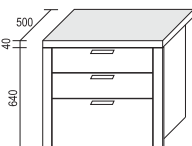
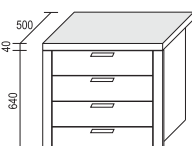
Descrizione <i>Description</i>	CODICE <i>CODE</i>	melaminico magnolia <i>magnolia melamine</i>	mel.decorativo tessuto <i>mel. decorative material</i>	mel. rovere termotrattato <i>mel. heat-treated oak</i>	lacc. opaco <i>mat lacq.</i>
CASSETTIERA 1 cestone comprensiva di coperchio <i>INTERNAL DRAWER UNIT 1 deep drawer including top</i> 	L. 478	<b>164</b>	<b>164</b>	<b>164</b>	<b>201</b>
	L. 600	<b>177</b>	<b>177</b>	<b>177</b>	<b>219</b>
	L. 700	<b>184</b>	<b>184</b>	<b>184</b>	<b>232</b>
	L. 981	<b>213</b>	<b>213</b>	<b>213</b>	<b>273</b>
	L. 1225	<b>241</b>	<b>241</b>	<b>241</b>	<b>311</b>
	L. 1425	<b>264</b>	<b>264</b>	<b>264</b>	<b>341</b>
	CASSETTIERA 2 cassetti comprensiva di coperchio <i>INTERNAL DRAWER UNIT 2 drawers including top</i> 	L. 478	<b>206</b>	<b>206</b>	<b>206</b>
L. 600		<b>221</b>	<b>221</b>	<b>221</b>	<b>267</b>
L. 700		<b>232</b>	<b>232</b>	<b>232</b>	<b>282</b>
L. 981		<b>260</b>	<b>260</b>	<b>260</b>	<b>322</b>
L. 1225		<b>291</b>	<b>291</b>	<b>291</b>	<b>364</b>
L. 1425		<b>322</b>	<b>322</b>	<b>322</b>	<b>403</b>
CASSETTIERA 2 cassetti comprensiva di coperchio <i>INTERNAL DRAWER UNIT 2 deep drawers including top</i> 		L. 478	<b>228</b>	<b>228</b>	<b>228</b>
	L. 600	<b>246</b>	<b>246</b>	<b>246</b>	<b>300</b>
	L. 700	<b>254</b>	<b>254</b>	<b>254</b>	<b>316</b>
	L. 981	<b>293</b>	<b>293</b>	<b>293</b>	<b>366</b>
	L. 1225	<b>328</b>	<b>328</b>	<b>328</b>	<b>415</b>
	L. 1425	<b>357</b>	<b>357</b>	<b>357</b>	<b>452</b>
	CASSETTIERA 2 cassetti e 1 cestone comprensiva di coperchio <i>INTERNAL DRAWER UNIT 2 drawers and 1 deep drawer including top</i> 	L. 478	<b>260</b>	<b>260</b>	<b>260</b>
L. 600		<b>277</b>	<b>277</b>	<b>277</b>	<b>341</b>
L. 700		<b>287</b>	<b>287</b>	<b>287</b>	<b>357</b>
L. 981		<b>324</b>	<b>324</b>	<b>324</b>	<b>407</b>
L. 1225		<b>362</b>	<b>362</b>	<b>362</b>	<b>461</b>
L. 1425		<b>389</b>	<b>389</b>	<b>389</b>	<b>496</b>
CASSETTIERA 4 cassetti comprensiva di coperchio <i>INTERNAL DRAWER UNIT 4 drawers including top</i> 		L. 478	<b>322</b>	<b>322</b>	<b>322</b>
	L. 600	<b>341</b>	<b>341</b>	<b>341</b>	<b>411</b>
	L. 700	<b>353</b>	<b>353</b>	<b>353</b>	<b>429</b>
	L. 981	<b>393</b>	<b>393</b>	<b>393</b>	<b>483</b>
	L. 1225	<b>435</b>	<b>435</b>	<b>435</b>	<b>542</b>
	L. 1425	<b>465</b>	<b>465</b>	<b>465</b>	<b>581</b>

# ATTREZZATURA INTERNA | OPTIONS

elementi per cassettiere interne con frontali vetro | *elements for internal drawer units with glass fronts*

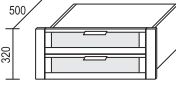
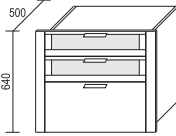
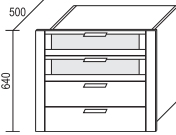
Descrizione <i>Description</i>	CODICE <i>CODE</i>	melaminico magnolia <i>magnolia melamine</i>	mel.decorativo tessuto <i>mel. decorative material</i>	mel. rovere termotrattato <i>mel. heat-treated oak</i>	lacc. opaco <i>matt lacq.</i>	
CASSETTIERA 2 cassetti vetro attenzione: aggiungere sempre il coperchio <i>INTERNAL DRAWER UNIT 2 glass drawers</i> <i>attention: always add the top</i>	L. 478	EMXC1312	<b>224</b>	<b>224</b>	<b>224</b>	<b>248</b>
	L. 600	EMXC1322	<b>236</b>	<b>236</b>	<b>236</b>	<b>262</b>
	L. 700	EMXC1332	<b>244</b>	<b>244</b>	<b>244</b>	<b>270</b>
	L. 981	EMXC1342	<b>261</b>	<b>261</b>	<b>261</b>	<b>289</b>
	L. 1225	EMXC1352	<b>279</b>	<b>279</b>	<b>279</b>	<b>312</b>
	L. 1425	EMXC1362	<b>302</b>	<b>302</b>	<b>302</b>	<b>338</b>
 CASSETTIERA 2 cassetti vetro e 1 cestone attenzione: aggiungere sempre il coperchio <i>INTERNAL DRAWER UNIT 2 glass drawers and 1 deep drawer</i> <i>attention: always add the top</i>	L. 478	EMXC3314	<b>279</b>	<b>279</b>	<b>279</b>	<b>319</b>
	L. 600	EMXC3324	<b>292</b>	<b>292</b>	<b>292</b>	<b>335</b>
	L. 700	EMXC3334	<b>299</b>	<b>299</b>	<b>299</b>	<b>346</b>
	L. 981	EMXC3344	<b>325</b>	<b>325</b>	<b>325</b>	<b>375</b>
	L. 1225	EMXC3354	<b>349</b>	<b>349</b>	<b>349</b>	<b>408</b>
	L. 1425	EMXC3364	<b>370</b>	<b>370</b>	<b>370</b>	<b>432</b>
 CASSETTIERA 2 cassetti vetro + 2 cassetti attenzione: aggiungere sempre il coperchio <i>INTERNAL DRAWER UNIT 2 glass drawers + 2 drawers</i> <i>attention: always add the top</i>	L. 478	EMXC4314	<b>341</b>	<b>341</b>	<b>341</b>	<b>388</b>
	L. 600	EMXC4324	<b>356</b>	<b>356</b>	<b>356</b>	<b>406</b>
	L. 700	EMXC4334	<b>365</b>	<b>365</b>	<b>365</b>	<b>419</b>
	L. 981	EMXC4344	<b>393</b>	<b>393</b>	<b>393</b>	<b>451</b>
	L. 1225	EMXC4354	<b>422</b>	<b>422</b>	<b>422</b>	<b>489</b>
	L. 1425	EMXC4364	<b>445</b>	<b>445</b>	<b>445</b>	<b>515</b>
 CASSETTIERA 4 cassetti vetro attenzione: aggiungere sempre il coperchio <i>INTERNAL DRAWER UNIT 4 glass drawers</i> <i>attention: always add the top</i>	L. 478	EMXC4414	<b>393</b>	<b>393</b>	<b>393</b>	<b>440</b>
	L. 600	EMXC4424	<b>408</b>	<b>408</b>	<b>408</b>	<b>458</b>
	L. 700	EMXC4434	<b>418</b>	<b>418</b>	<b>418</b>	<b>471</b>
	L. 981	EMXC4444	<b>446</b>	<b>446</b>	<b>446</b>	<b>504</b>
	L. 1225	EMXC4454	<b>476</b>	<b>476</b>	<b>476</b>	<b>543</b>
	L. 1425	EMXC4464	<b>499</b>	<b>499</b>	<b>499</b>	<b>570</b>

# ATTREZZATURA INTERNA | OPTIONS

## cassettiere interne con frontali vetro | *internal drawer units with glass fronts*

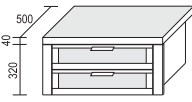
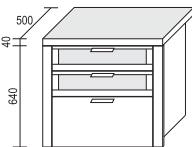
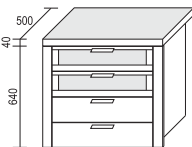
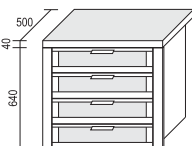
Descrizione <i>Description</i>	CODICE <i>CODE</i>	melaminico magnolia <i>magnolia melamine</i>	mel.decorativo tessuto <i>mel. decorative material</i>	mel. rovere termotrattato <i>mel. heat-treated oak</i>	lacc. opaco <i>mat lacq.</i>
CASSETTIERA 2 cassetti vetro comprensiva di coperchio <i>INTERNAL DRAWER UNIT 2 glass drawers            including top</i> 	L. 478	<b>258</b>	<b>258</b>	<b>258</b>	<b>298</b>
	L. 600	<b>274</b>	<b>274</b>	<b>274</b>	<b>320</b>
	L. 700	<b>284</b>	<b>284</b>	<b>284</b>	<b>334</b>
	L. 981	<b>314</b>	<b>314</b>	<b>314</b>	<b>375</b>
	L. 1225	<b>345</b>	<b>345</b>	<b>345</b>	<b>418</b>
	L. 1425	<b>376</b>	<b>376</b>	<b>376</b>	<b>457</b>
	CASSETTIERA 2 cassetti vetro e 1 cestone comprensiva di coperchio <i>INTERNAL DRAWER UNIT 2 glass drawers and 1 deep drawer            including top</i> 	L. 478	<b>313</b>	<b>313</b>	<b>313</b>
L. 600		<b>330</b>	<b>330</b>	<b>330</b>	<b>393</b>
L. 700		<b>339</b>	<b>339</b>	<b>339</b>	<b>410</b>
L. 981		<b>378</b>	<b>378</b>	<b>378</b>	<b>461</b>
L. 1225		<b>415</b>	<b>415</b>	<b>415</b>	<b>514</b>
L. 1425		<b>444</b>	<b>444</b>	<b>444</b>	<b>551</b>
CASSETTIERA 2 cassetti vetro + 2 cassetti comprensiva di coperchio <i>INTERNAL DRAWER UNIT 2 glass drawers + 2 drawers            including top</i> 		L. 478	<b>375</b>	<b>375</b>	<b>375</b>
	L. 600	<b>394</b>	<b>394</b>	<b>394</b>	<b>464</b>
	L. 700	<b>405</b>	<b>405</b>	<b>405</b>	<b>483</b>
	L. 981	<b>446</b>	<b>446</b>	<b>446</b>	<b>537</b>
	L. 1225	<b>488</b>	<b>488</b>	<b>488</b>	<b>595</b>
	L. 1425	<b>519</b>	<b>519</b>	<b>519</b>	<b>634</b>
	CASSETTIERA 4 cassetti vetro comprensiva di coperchio <i>INTERNAL DRAWER UNIT 4 glass drawers            including top</i> 	L. 478	<b>427</b>	<b>427</b>	<b>427</b>
L. 600		<b>446</b>	<b>446</b>	<b>446</b>	<b>516</b>
L. 700		<b>458</b>	<b>458</b>	<b>458</b>	<b>535</b>
L. 981		<b>499</b>	<b>499</b>	<b>499</b>	<b>590</b>
L. 1225		<b>542</b>	<b>542</b>	<b>542</b>	<b>649</b>
L. 1425		<b>573</b>	<b>573</b>	<b>573</b>	<b>689</b>



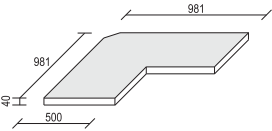
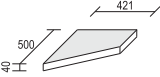

# ATTREZZATURA INTERNA | OPTIONS

## ripiani | shelves

Descrizione <i>Description</i>	CODICE <i>CODE</i>	melaminico magnolia <i>magnolia melamine</i>	mel.decorativo tessuto <i>mel. decorative material</i>	mel. rovere termotrattato <i>mel. heat-treated oak</i>	lacc. opaco <i>matt lacq.</i>	
RIPIANO   SHELF  	L. 478	EMR10210	<b>34</b>	<b>34</b>	<b>34</b>	<b>50</b>
	L. 600	EMR10220	<b>38</b>	<b>38</b>	<b>38</b>	<b>58</b>
	L. 700	EMR10230	<b>40</b>	<b>40</b>	<b>40</b>	<b>64</b>
	L. 981	EMR10240	<b>53</b>	<b>53</b>	<b>53</b>	<b>86</b>
	L. 1225	EMR10250	<b>66</b>	<b>66</b>	<b>66</b>	<b>106</b>
	L. 1425	EMR10260	<b>74</b>	<b>74</b>	<b>74</b>	<b>119</b>
RIPIANO per angolo <i>SHELF for corner unit</i>  	L. 1425	EMR15420	<b>116</b>	<b>116</b>	<b>116</b>	<b>175</b>
RIPIANO per terminale a disegno dx <i>SHELF for end unit in the drawing, rh</i>  	dx - rh	EMR20200	<b>42</b>	<b>42</b>	<b>42</b>	<b>54</b>
	sx - lh	EMR20200	<b>42</b>	<b>42</b>	<b>42</b>	<b>54</b>

# ATTREZZATURA INTERNA | OPTIONS

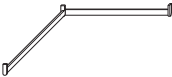
## tubi appendiabiti e servetti | clothes hangers and clothes lifts

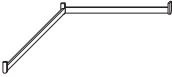
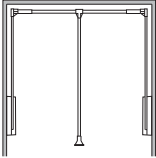
Descrizione <i>Description</i>		CODICE <i>CODE</i>	finitura alluminio <i>aluminium finish</i>
<p>TUBO APPENDIABITI <b>ECO</b> - sezione ovale per il vano L. 1225 e 1425 il tubo ha un supporto centrale <i>CLOTHES HANGER ECO - oval section for compartment L. 1225 and 1425 the hanger has a central support</i></p> 	L. 478	EMXT0234	<b>7</b>
	L. 600	EMXT0244	<b>7</b>
	L. 700	EMXT0254	<b>8</b>
	L. 981	EMXT0264	<b>9</b>
	L. 1225	EMXT0274	<b>13</b>
	L. 1425	EMXT0284	<b>16</b>
<p>TUBO APPENDIABITI PER ANGOLO <b>ECO</b> - sezione ovale <i>CLOTHES HANGER FOR CORNER UNIT ECO - oval section</i></p> 	L. 981 x 981	EMXT0214	<b>16</b>
<p>TUBO APPENDIABITI <b>VIP</b> - sezione quadra per il vano L. 1225 e 1425 il tubo ha un supporto centrale <i>CLOTHES HANGER VIP - square section for compartment L. 1225 and 1425 the hanger has a central support</i></p> 	L. 478	EMXT0334	<b>12</b>
	L. 600	EMXT0344	<b>13</b>
	L. 700	EMXT0354	<b>14</b>
	L. 981	EMXT0364	<b>16</b>
	L. 1225	EMXT0374	<b>22</b>
	L. 1425	EMXT0384	<b>24</b>
<p>TUBO APPENDIABITI PER ANGOLO <b>VIP</b> - sezione quadra <i>CLOTHES HANGER FOR CORNER UNIT VIP - square section</i></p> 	L. 981 x 981	EMXT0314	<b>28</b>
<p>SERVETTO estensibile <i>CLOTHES LIFT extensible</i></p> 	L. 478 - 600	EMXSE002	<b>116</b>
	L. 700 - 981	EMXSE004	<b>116</b>
	L. 1225	EMXSE006	<b>116</b>



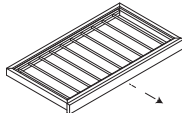
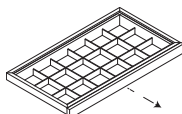
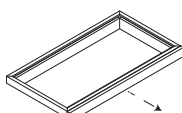
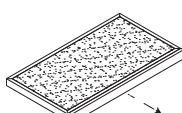
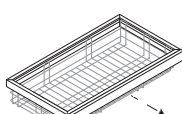
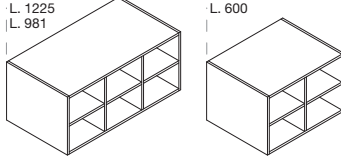
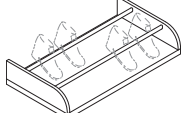

# ATTREZZATURA INTERNA | OPTIONS

accessori | *accessories*

Descrizione <i>Description</i>		CODICE <i>CODE</i>	melaminico <i>melamine</i>	lacc. opaco <i>mat lacq.</i>
PORTAPANTALONI ESTRAIBILE <i>EXTRACTABLE TROUSERS RACK</i> 	L. 600	EMXPPA04	<b>192</b>	<b>207</b>
	L. 981	EMXPPA06	<b>229</b>	<b>248</b>
	L. 1225	EMXPPA08	<b>255</b>	<b>274</b>
PORTACRAVATTE ESTRAIBILE con separatore in legno <i>EXTRACTABLE TIE RACK with wooden divider</i> 	L. 600	EMXPCA04	<b>248</b>	<b>263</b>
	L. 981	EMXPCA06	<b>297</b>	<b>315</b>
	L. 1225	EMXPCA08	<b>330</b>	<b>349</b>
VASSOIO CON VASCHETTA ESTRAIBILE <i>EXTRACTABLE TRAY RACK</i> 	L. 600	EMXVES04	<b>195</b>	<b>210</b>
	L. 981	EMXVES06	<b>229</b>	<b>248</b>
	L. 1225	EMXVES08	<b>267</b>	<b>285</b>
VASSOIO CON PIANETTO ESTRAIBILE <i>TRAY WITH EXTRACTABLE TOP</i> 	L. 600	EMXVPIO4	<b>183</b>	<b>211</b>
	L. 981	EMXVPIO6	<b>217</b>	<b>259</b>
	L. 1225	EMXVPIO8	<b>244</b>	<b>293</b>
CESTELLO ESTRAIBILE <i>EXTRACTABLE BASKET</i> 	L. 981	EMXCE002	<b>287</b>	<b>305</b>
	L. 1225	EMXCE004	<b>330</b>	<b>349</b>
RASTER IN APPOGGIO H. 384 x P. 500 <i>LEANING RASTER H. 384 x D. 500</i> 	L. 600	EMR30220	<b>149</b>	<b>258</b>
	L. 981	EMR30240	<b>193</b>	<b>381</b>
	L. 1225	EMR30250	<b>220</b>	<b>431</b>
PORTA SCARPE SOSPESO H. 160 x P. 500 <i>SUSPENDED SHOE-RACK H. 160 x D. 500</i> 	L. 600	EMXPSC04	<b>125</b>	<b>156</b>
	L. 981	EMXPSC06	<b>151</b>	<b>196</b>
	L. 1225	EMXPSC08	<b>172</b>	<b>223</b>

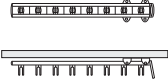
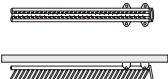



# ATTREZZATURA INTERNA | *OPTIONS*

accessori | *accessories*

<b>Descrizione</b> <i>Description</i>	<b>CODICE</b> <i>CODE</i>	<b>prezzo</b> <i>price</i>
<p>PORTACINTURE ESTRAIBILE                      da fissare ai fianchi o alle divisioni                      EXTRACTABLE BELT RACK                      to be fixed onto the sides or partitions</p> 	EMXPC003	<b>94</b>
<p>PORTACRAVATTE ESTRAIBILE                      da fissare ai fianchi o alle divisioni                      EXTRACTABLE TIE RACK                      to be fixed onto the sides or partitions</p> 	EMXPC002	<b>55</b>
<p>GRUCCIA IN LEGNO                      WOODEN CLOTHES HANGER</p> 	EMXGR002	<b>39</b>
<p>SCATOLA rivestita in tessuto                      BOX covered by fabric</p> 	L. 260 H. 260 P./D. 480 EMXSC002	<b>69</b>
<p>SCATOLA rivestita in tessuto                      BOX covered by fabric</p> 	L. 400 H. 260 P./D. 480 EMXSC004	<b>76</b>

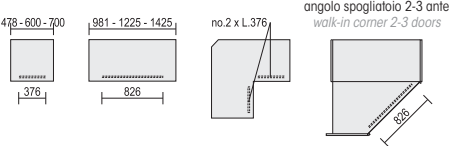

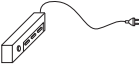

# ATTREZZATURA INTERNA | OPTIONS

accessori | accessories

<b>Descrizione</b> <i>Description</i>	<b>CODICE</b> <b>CODE</b>	<b>prezzo</b> <b>price</b>						
<p>APPENDINO finitura alluminio  <i>HANGER aluminium finish</i></p> 	<p>EMXAP001</p>	<p><b>6</b></p>						
<p>LAMPADA LED AD INCASSO con sensore, da completare con kit di connessione  <i>BUILT-IN LED LAMP with a movement reading sensor, to be completed with connecting kit</i></p> <p>Esempi di utilizzo   <i>Examples of use</i></p>   <table border="1" data-bbox="991 1279 1474 1368"> <tr> <td>L. 376</td> <td>EMXLI223</td> <td><b>172</b></td> </tr> <tr> <td>L. 826</td> <td>EMXLI243</td> <td><b>212</b></td> </tr> </table>	L. 376	EMXLI223	<b>172</b>	L. 826	EMXLI243	<b>212</b>		
L. 376	EMXLI223	<b>172</b>						
L. 826	EMXLI243	<b>212</b>						
<p>KIT DI CONNESSIONE per lampada led + 1 prolunga  1 kit supporta massimo 6 lampade L. 376 e 3 L. 826  <i>CONNECTING KIT for led lamp + 1 extension cord 1 kit support 6 lamps max L. 376 and 3 L. 826</i></p> 	<p>KIT</p> <p>EMXTL163</p>	<p><b>37</b></p>						
<p>SPECCHIO INTERNO ORIENTABILE per anta battente e schiena angolo spogliatoio  <i>SWING INTERNAL MIRROR for regular door and back of walk-in corner</i></p> 	<p>L. 350 x H. 1400</p> <p>EMXSP002</p>	<p><b>130</b></p>						

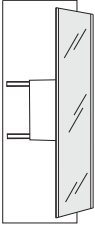
# ATTREZZATURA INTERNA | OPTIONS

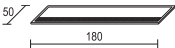
accessori | *accessories*

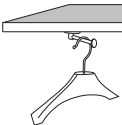
<b>Descrizione</b> <i>Description</i>	<b>CODICE</b> <b>CODE</b>	<b>prezzo</b> <i>price</i>
<p>SPECCHIO INTERNO ESTRAIBILE E ORIENTABILE per armadio scorrevole, da fissare ai fianchi o alle divisioni  <i>PULL OUT AND SWING INTERNAL MIRROR for sliding unit, to be assembled onto the sides or partitions</i></p>  <p>L. 350 x H. 1400</p>	EMXSP004	<b>282</b>
<p>COPRIFORO da posizionare su schiene  <i>HOLE-COVER to be placed on back panels</i></p>  <p>Ø 80</p>	<p>copriforo grigio   <i>grey hole-cover</i>                      lavorazione per copriforo  <i>machining for hole-cover</i></p>	<p><b>20</b> <b>49</b></p>
<p>PASSACAVI da posizionare su ripiani o piani scrivania  <i>CABLE HITCHES to be placed on shelves and desk tops</i></p>  <p>50 180</p>	<p>passacavi bianco   <i>white core hitches</i>                      passacavi nero   <i>black core hitches</i>                      lavorazione per passacavi  <i>machining for core hitches</i></p>	<p><b>48</b> <b>48</b> <b>49</b></p>
<p>ASTA APPENDIABITI  <i>STICK FOR HANGERS</i></p> 	EMXAA002	<b>27</b>
<p>APPENDIGRUCCE GIREVOLE da posizionare sotto il ripiano  <i>REVOLVING SUPPORT FOR CLOTHES HANGER, to be positioned under the shelf</i></p> 	EMXAG002	<b>26</b>

# EMOTION

soluzioni su misura | *custom solutions*

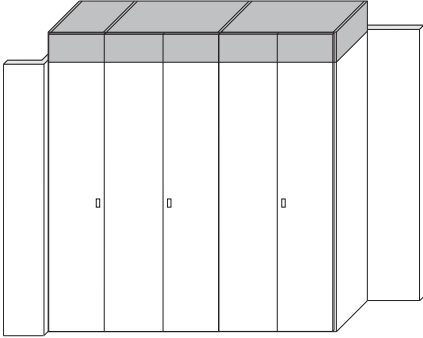
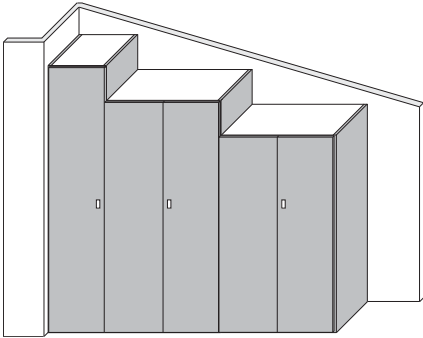
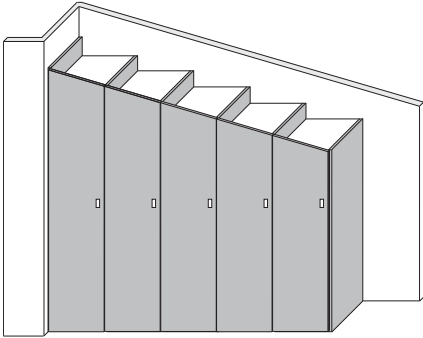
DESCRIZIONE   <i>DESCRIPTION</i>	sovrapprezzo per elemento <i>increase per element</i>												
 <p>RIDUZIONE IN ALTEZZA - esempio A Lavorazione effettuabile solo su vani battenti. <i>MADE TO MEASURE HEIGHT - example A</i> <i>Practicable only on regular doors units</i></p> <ul style="list-style-type: none"> <li>* elemento anta singola   <i>single door unit</i></li> <li>* elemento anta doppia   <i>double doors unit</i></li> <li>* elemento ad angolo   <i>corner unit</i></li> <li>** elemento terminale   <i>end unit</i></li> <li>fianco   <i>side panel</i></li> <li>divisione   <i>partition</i></li> </ul>	<table border="1"> <tr><td>* elemento anta singola   <i>single door unit</i></td><td><b>84</b></td></tr> <tr><td>* elemento anta doppia   <i>double doors unit</i></td><td><b>156</b></td></tr> <tr><td>* elemento ad angolo   <i>corner unit</i></td><td><b>180</b></td></tr> <tr><td>** elemento terminale   <i>end unit</i></td><td><b>84</b></td></tr> <tr><td>fianco   <i>side panel</i></td><td><b>49</b></td></tr> <tr><td>divisione   <i>partition</i></td><td><b>49</b></td></tr> </table>	* elemento anta singola   <i>single door unit</i>	<b>84</b>	* elemento anta doppia   <i>double doors unit</i>	<b>156</b>	* elemento ad angolo   <i>corner unit</i>	<b>180</b>	** elemento terminale   <i>end unit</i>	<b>84</b>	fianco   <i>side panel</i>	<b>49</b>	divisione   <i>partition</i>	<b>49</b>
* elemento anta singola   <i>single door unit</i>	<b>84</b>												
* elemento anta doppia   <i>double doors unit</i>	<b>156</b>												
* elemento ad angolo   <i>corner unit</i>	<b>180</b>												
** elemento terminale   <i>end unit</i>	<b>84</b>												
fianco   <i>side panel</i>	<b>49</b>												
divisione   <i>partition</i>	<b>49</b>												
 <p>RIDUZIONE IN ALTEZZA - esempio B Lavorazione effettuabile solo su vani battenti. <i>MADE TO MEASURE HEIGHT - example B</i> <i>Practicable only on regular doors units</i></p> <ul style="list-style-type: none"> <li>* elemento anta singola   <i>single door unit</i></li> <li>* elemento anta doppia   <i>double doors unit</i></li> <li>* elemento ad angolo   <i>corner unit</i></li> <li>** elemento terminale   <i>end unit</i></li> <li>fianco   <i>side panel</i></li> <li>divisione   <i>partition</i></li> </ul>	<table border="1"> <tr><td>* elemento anta singola   <i>single door unit</i></td><td><b>84</b></td></tr> <tr><td>* elemento anta doppia   <i>double doors unit</i></td><td><b>156</b></td></tr> <tr><td>* elemento ad angolo   <i>corner unit</i></td><td><b>180</b></td></tr> <tr><td>** elemento terminale   <i>end unit</i></td><td><b>84</b></td></tr> <tr><td>fianco   <i>side panel</i></td><td><b>49</b></td></tr> <tr><td>divisione   <i>partition</i></td><td><b>49</b></td></tr> </table>	* elemento anta singola   <i>single door unit</i>	<b>84</b>	* elemento anta doppia   <i>double doors unit</i>	<b>156</b>	* elemento ad angolo   <i>corner unit</i>	<b>180</b>	** elemento terminale   <i>end unit</i>	<b>84</b>	fianco   <i>side panel</i>	<b>49</b>	divisione   <i>partition</i>	<b>49</b>
* elemento anta singola   <i>single door unit</i>	<b>84</b>												
* elemento anta doppia   <i>double doors unit</i>	<b>156</b>												
* elemento ad angolo   <i>corner unit</i>	<b>180</b>												
** elemento terminale   <i>end unit</i>	<b>84</b>												
fianco   <i>side panel</i>	<b>49</b>												
divisione   <i>partition</i>	<b>49</b>												
 <p>RIDUZIONE IN ALTEZZA - esempio C Lavorazione effettuabile solo su vani battenti. <i>MADE TO MEASURE HEIGHT - example C</i> <i>Practicable only on regular doors units</i></p> <ul style="list-style-type: none"> <li>* elemento anta singola   <i>single door unit</i></li> <li>fianco   <i>side panel</i></li> <li>divisione   <i>partition</i></li> </ul>	<table border="1"> <tr><td>* elemento anta singola   <i>single door unit</i></td><td><b>118</b></td></tr> <tr><td>fianco   <i>side panel</i></td><td><b>49</b></td></tr> <tr><td>divisione   <i>partition</i></td><td><b>49</b></td></tr> </table>	* elemento anta singola   <i>single door unit</i>	<b>118</b>	fianco   <i>side panel</i>	<b>49</b>	divisione   <i>partition</i>	<b>49</b>						
* elemento anta singola   <i>single door unit</i>	<b>118</b>												
fianco   <i>side panel</i>	<b>49</b>												
divisione   <i>partition</i>	<b>49</b>												

\* Gli elementi anta singola, doppia e angolo comprendono: 1 coperchio - 1 fondo - schiena - 1 ripiano - 2 tubi - 1 o 2 ante \*\* L'elemento terminale comprende: 1 coperchio - 1 fondo - schiena - 1 ripiano - 1 fianco terminale - 1 anta  
\* Single, double and corner door elements include: 1 top - 1 bottom - back - 1 shelf - 2 hangers - 1 or 2 doors \*\* The end unit element includes: 1 top - 1 bottom - back - 1 shelf - 1 end unit side - 1 door

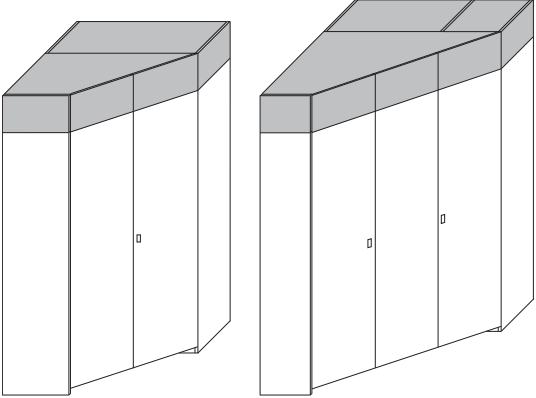
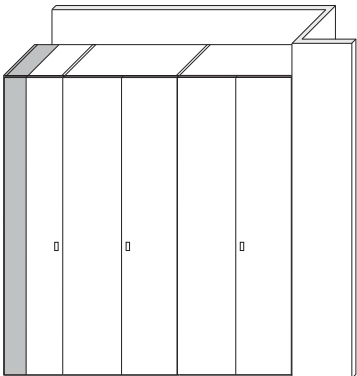
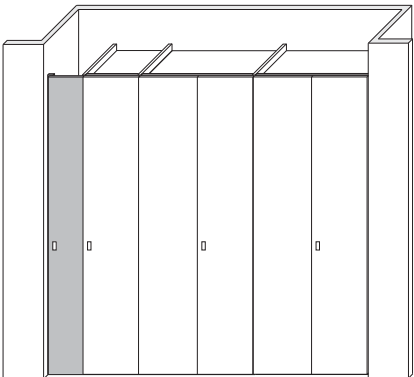
DESCRIZIONE   DESCRIPTION	sovrapprezzo per elemento increase per element
<div style="display: flex; align-items: center;">  <div style="margin-left: 20px;"> <p>RIDUZIONE IN ALTEZZA - esempio D MADE TO MEASURE HEIGHT - example D</p> </div> </div>	
<p>angolo spogliatoio 2 ante   <i>walk-in corner 2-doors</i></p>	<b>360</b>
<p>angolo spogliatoio 3 ante   <i>walk-in corner 3-doors</i></p>	<b>516</b>
<div style="display: flex; align-items: center;">  <div style="margin-left: 20px;"> <p>RIDUZIONE IN LARGHEZZA Lavorazione effettuabile solo su vani battenti, esclusi quelli con ante a superficie termoformata. Sui vani anta doppia la riduzione viene effettuata su tutte e due le ante. Per el. ad angolo il sovrapprezzo si riferisce alla riduzione di un lato. MADE TO MEASURE WIDTH <i>Practicable only on regular doors unit, except for those with thermoformed surface doors. On double door units the cut is executed on both doors. The cut of corner element refers only to the reduction of 1 side.</i></p> </div> </div>	
<p>* elemento anta singola   <i>single door unit</i></p>	<b>180</b>
<p>* elemento anta doppia   <i>double door unit</i></p>	<b>240</b>
<p>* elemento ad angolo   <i>corner unit</i></p>	<b>180</b> per ogni lato   <i>per every side</i>
<p>ripiano   <i>shelf</i></p>	<b>37</b>
<p>tubo appendiabiti   <i>clothes hanger</i></p>	<b>22</b>
<div style="display: flex; align-items: center;">  <div style="margin-left: 20px;"> <p>ANTA SU MISURA USO RIPOSTIGLIO Lavorazione effettuabile solo su vani battenti, esclusi quelli con ante a superficie termoformata, e ante telaio vetro glass. Soluzione possibile solo su nicchia. N.B.: prendere il prezzo dell'anta battente della misura e finitura occorrente e applicare il sovrapprezzo indicato (il sovrapprezzo comprende il taglio dell'anta, la foratura sulla divisione e il montante da fissare al muro).</p> <p>MADE TO MEASURE DOOR, USED AS STORE ROOM <i>Practicable only on regular doors unit, except for those with thermoformed surface doors and glass vetro door. Practicable only on a niche.</i> NOTE: take the price of the regular door of necessary size and finish and apply the required increase indicated (the increase includes the cutting of the door, the drilling on the partition and the upright to be fixed to the wall).</p> </div> </div>	
<p>anta battente   <i>regular door</i></p>	<b>124</b>

\* Gli elementi anta singola, doppia e angolo comprendono: 1 coperchio - 1 fondo - schiena - 1 ripiano - 2 tubi - 1 o 2 ante  
\* Single, double and corner door elements include: 1 top - 1 bottom - back - 1 shelf - 2 hangers - 1 or 2 doors



# EMOTION

## soluzioni su misura | custom solutions

Attenzione: negli elementi ridotti in profondità non è possibile inserire il tubo appendiabiti | Attention: clothes hangers can't be added inside units reduced in depth

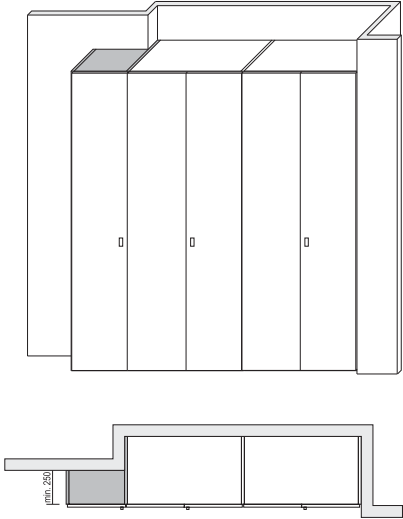
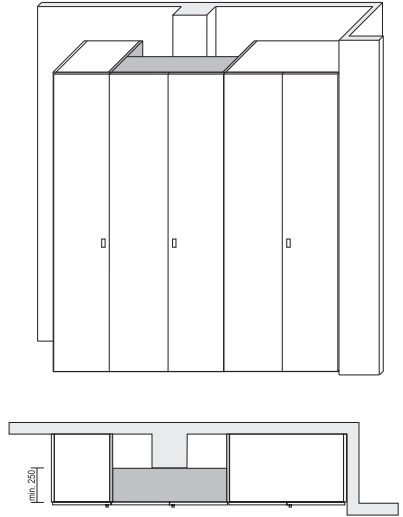
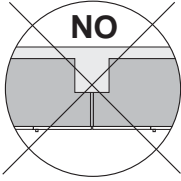
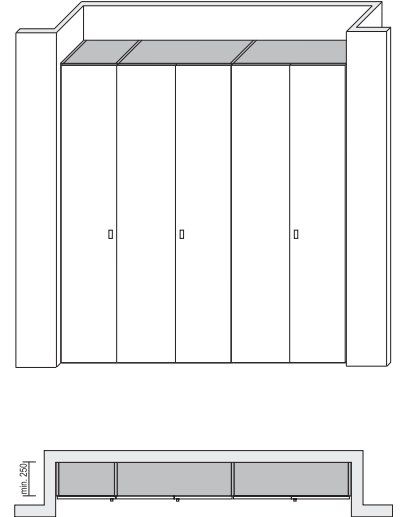
DESCRIZIONE   DESCRIPTION	sovrapprezzo per elemento increase per element
 <p>RIDUZIONE IN PROFONDITÀ - esempio A Lavorazione effettuabile su vani battenti e scorrevoli. Riduzione minima possibile fino a 250 mm. <i>MADE TO MEASURE DEPTH - example A</i> <i>Praticabile on regular or sliding doors unit.</i> <i>Minimum possible reduction up to 250 mm.</i></p> <p>* elemento anta singola-doppia   <i>single-double door unit</i></p> <p>ripiano   <i>shelf</i></p> <p>fianco   <i>side panel</i></p> <p>divisione   <i>partition</i></p>	<p><b>109</b></p> <p><b>37</b></p> <p><b>49</b></p> <p><b>49</b></p>
 <p>RIDUZIONE IN PROFONDITÀ - esempio B Lavorazione effettuabile su vani battenti e scorrevoli. Riduzione minima possibile fino a 250 mm. <i>MADE TO MEASURE DEPTH - example B</i> <i>Praticabile on regular or sliding doors unit.</i> <i>Minimum possible reduction up to 250 mm.</i></p> <p>* elemento anta singola-doppia   <i>single-double door unit</i></p> <p>ripiano   <i>shelf</i></p> <p>fianco   <i>side panel</i></p> <p>divisione   <i>partition</i></p>	 <p><b>109</b></p> <p><b>37</b></p> <p><b>49</b></p> <p><b>49</b></p>
 <p>RIDUZIONE IN PROFONDITÀ - esempio C Lavorazione effettuabile su vani battenti e scorrevoli. Riduzione minima possibile fino a 250 mm. <i>MADE TO MEASURE DEPTH - example C</i> <i>Praticabile on regular or sliding doors unit.</i> <i>Minimum possible reduction up to 250 mm.</i></p> <p>* elemento anta singola-doppia   <i>single-double door unit</i></p> <p>ripiano   <i>shelf</i></p> <p>fianco   <i>side panel</i></p> <p>divisione   <i>partition</i></p>	<p><b>109</b></p> <p><b>37</b></p> <p><b>49</b></p> <p><b>49</b></p>

\* Gli elementi anta singola, doppia e angolo comprendono: 1 coperchio - 1 fondo - schiena - 1 ripiano - 2 tubi - 1 o 2 ante

\* Single, double and corner door elements include: 1 top - 1 bottom - back - 1 shelf - 2 hangers - 1 or 2 doors

# EMOTION

soluzioni su misura | *custom solutions*

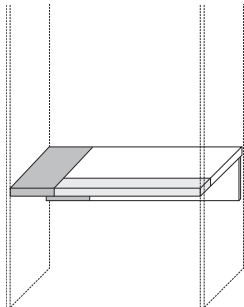
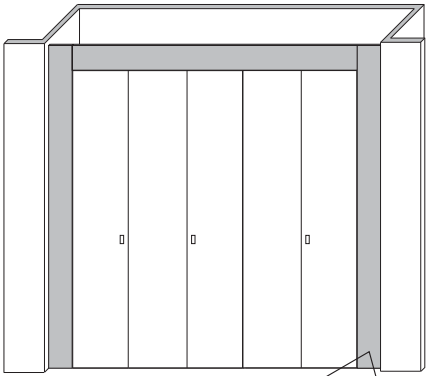
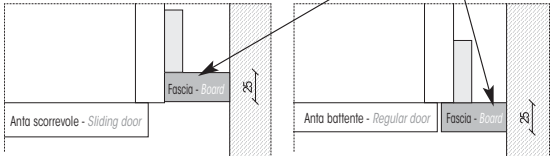
DESCRIZIONE   DESCRIPTION		sovrapprezzo per elemento <i>increase per element</i>																						
	RIDUZIONE CASSETTIERA IN LARGHEZZA <i>MADE TO MEASURE WIDTH OF INT. DRAWER UNIT</i>																							
	<table border="1"> <tr> <td>cassettiera   <i>internal drawer unit</i></td> <td><b>257</b></td> <td colspan="5"></td> </tr> <tr> <td>coperchio cassettera   <i>top for internal drawer unit</i></td> <td><b>49</b></td> <td colspan="5"></td> </tr> </table>	cassettiera   <i>internal drawer unit</i>	<b>257</b>						coperchio cassettera   <i>top for internal drawer unit</i>	<b>49</b>														
cassettiera   <i>internal drawer unit</i>	<b>257</b>																							
coperchio cassettera   <i>top for internal drawer unit</i>	<b>49</b>																							
	RIDUZIONE PIANO SCRIVANIA <i>MADE TO MEASURE DESK TOP</i>																							
	<table border="1"> <tr> <td>larghezza   <i>width</i></td> <td><b>97</b></td> <td colspan="5"></td> </tr> <tr> <td>profondità   <i>depth</i></td> <td><b>60</b></td> <td colspan="5"></td> </tr> </table>	larghezza   <i>width</i>	<b>97</b>						profondità   <i>depth</i>	<b>60</b>														
larghezza   <i>width</i>	<b>97</b>																							
profondità   <i>depth</i>	<b>60</b>																							
<p><b>LACCATO A CAMPIONE</b> Comunicare codice RAL di riferimento. <b>LACQUERED AS PER THE SAMPLE</b> <i>Specify reference RAL code.</i></p>		maggiorazione   <i>surcharge + 20 %</i>																						
 <p><b>FASCIA DI TAMPONAMENTO</b> Larghezza max 300 mm Larghezza minima 40 mm Lunghezza max 3200 mm Lunghezza max 2700 mm (Olmo)</p> <p><b>FITTING BOARD</b> Max width 300 mm Min width 40 mm Max length 3200 mm Max length 2700 mm (Elm)</p>	CODICE	melaminico olmo	laccato opaco	essenza	rovere laccato poro aperto	rovere termotrattato	laccato lucido																	
	CODE	elm melamine	mat lacq.	wood	open pore lacq. oak	heat- treated oak	glossy lacq.																	
 <p>al ml.   <i>per m.</i></p> <table border="1"> <tr> <td>orizzontale   <i>horizontal</i></td> <td>EMXFT163</td> <td><b>48</b></td> <td><b>54</b></td> <td><b>67</b></td> <td><b>76</b></td> <td><b>87</b></td> <td><b>79</b></td> </tr> <tr> <td>verticale   <i>vertical</i></td> <td>EMXFT263</td> <td><b>48</b></td> <td><b>54</b></td> <td><b>67</b></td> <td><b>76</b></td> <td><b>87</b></td> <td><b>79</b></td> </tr> </table>		orizzontale   <i>horizontal</i>	EMXFT163	<b>48</b>	<b>54</b>	<b>67</b>	<b>76</b>	<b>87</b>	<b>79</b>	verticale   <i>vertical</i>	EMXFT263	<b>48</b>	<b>54</b>	<b>67</b>	<b>76</b>	<b>87</b>	<b>79</b>							
orizzontale   <i>horizontal</i>	EMXFT163	<b>48</b>	<b>54</b>	<b>67</b>	<b>76</b>	<b>87</b>	<b>79</b>																	
verticale   <i>vertical</i>	EMXFT263	<b>48</b>	<b>54</b>	<b>67</b>	<b>76</b>	<b>87</b>	<b>79</b>																	
<p><b>NON SI ESEGUONO LAVORAZIONI A MISURA SU:</b> Ante con vetri o specchi, ante con serratura, ante scorrevoli, elementi terminali e angoli spogliatoio (possibili solo riduzioni in altezza), elementi ponte, ar. complanari. <b>MADE TO MEASURE CUTS ARE NOT PRATICABLE ON:</b> <i>Doors with glass or mirrors, doors with locks, sliding doors, end units and walk-in corners (only reductions in height are possible), span unit elements, flush-fitting doors wardrobes.</i></p>																								



# EMOTION

## modulo d'ordine | order form

### EMOTION

**Cliente / Customer:** \_\_\_\_\_

**Provincia-Stato / Province-State:** \_\_\_\_\_

**Data / Date:** \_\_\_\_\_

**Riferimento / Reference:** \_\_\_\_\_

**Consegna / Delivery:** \_\_\_\_\_

**TIPOLOGIA ANTE | DOORS TYPE**

BASIC  INCSA

ASOLA  ONDA

LINEAR  TECNO \*

DESIGN  COMPOSTA

SPRINT  COMPOSTA PLUS

SPRINT PLUS  GREEN

SIMPLY  VERTICAL

SIMPLY VETRO  RIGA

TECNO \*  TELAIO "O" \*

TECNO VETRO \*  TELAIO "A" \*

GLASS  TELAIO "C" \*

SLIDE  TELAIO "D" \*

\* Specificare la finitura telaio  
Specify frame finish

**FINITURA ANTE | DOORS FINISH**

Sup. termofornata  alto centrale  up central  basso  down  
*thermoformed surf.*

Lacc. opaco  Matr. lacq.

Essenza  Wood

Rovere l. poro aperto

Open pore lacq. oak

Lacc. lucido  Glossy lacq.

Rovere termotrattato  Heat-treated oak

Vetro o specchio  Glass or mirror

N.B.: Anta telaio "D" specificare ogni singolo pannello sul disegno.  
NOTE: door frame "D", specify every single panel on the picture.

**FINITURA MANIGLIE | HANDLES FINISH**

ALFA  BETA  VIP

GAMMA  OMEGA  RETTA

DELTA  LAMA H. 40  SERRATURA | LOCK

EPSILON  LAMA H. 330

**Largh. | Length** \_\_\_\_\_ **Altezza | Height** \_\_\_\_\_ **P. fianco | Side D.** \_\_\_\_\_

La larghezza totale dell'armadio si ottiene aggiungendo alla somma dei vani lo spessore dei fianchi e divisioni  
The total width of the cabinet is obtained by adding the thickness of the side panels and partitions to the units total

Battente | Regular door  Scorrevole | Sliding door

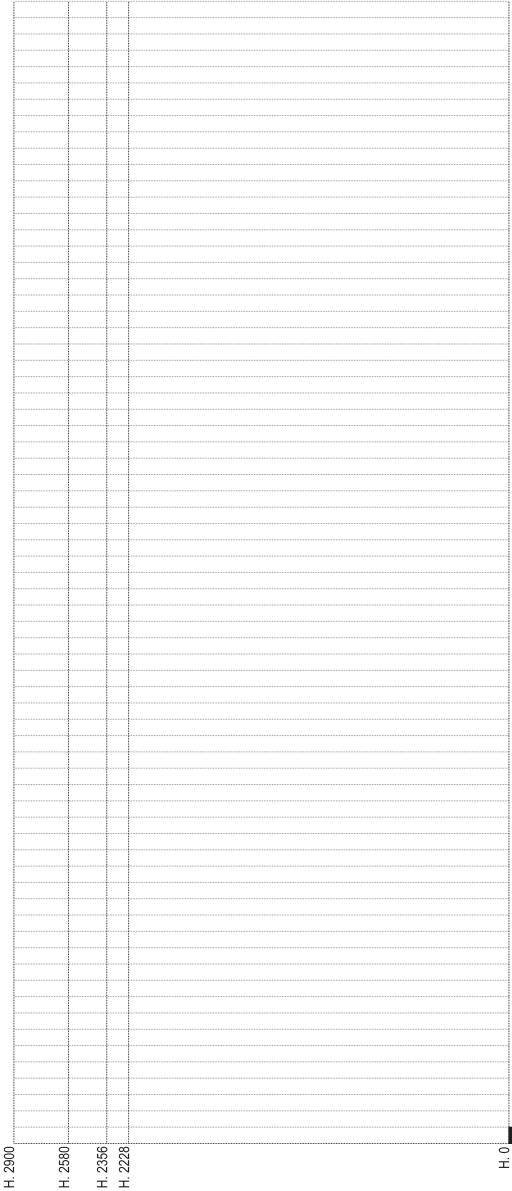

Attenzione: precisare il senso di apertura delle ante | Attention: specify the door opening

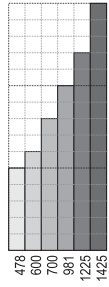
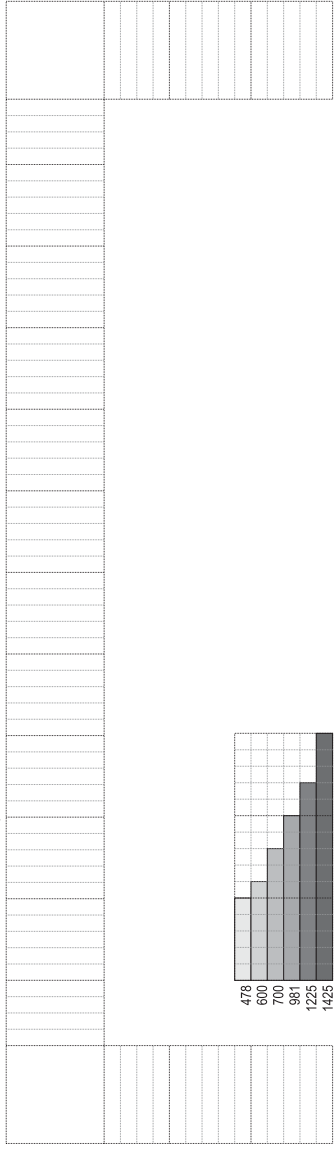

\* Solo per ripiani, cassettiere e divisioni interne tra ripiano e fondo  
Only for shelves, internal drawers and partitions between shelf and bottom

**FINITURA SCOCCA INTERNA | INTERNAL BODY FINISH**

Melaminico magnolia | *Magnolia melamine*

Melam. decorativo tessuto | *Decorative material melam.*

Lacc. opaco | *Matr lacq.* \_\_\_\_\_

Melam. rovere termotrattato | *heat-treated oak melam.* \*

**FINITURA SCOCCA ESTERNA | EXTERNAL BODY FINISH**

Lacc. opaco | *Matr lacq.* \_\_\_\_\_

Essenza | *Wood* \_\_\_\_\_

Rovere l. poro aperto | *open pore lacq. oak* \_\_\_\_\_

Lacc. lucido | *Glossy lacq.* \_\_\_\_\_

**NOTE | NOTE**

\_\_\_\_\_

\_\_\_\_\_

\_\_\_\_\_

\_\_\_\_\_

### EMOTION

Battente | Regular door     Scorrevole | Sliding door    Largh. | Length **4049**    Altezza | Height **2580**    P. fianco | Side D. **585**

La larghezza totale dell'armadio si ottiene aggiungendo alla somma dei vani lo spessore dei fianchi e divisioni  
The total width of the cabinet is obtained by adding the thickness of the side panels and partitions to the units total



Attenzione: precisare il senso di apertura delle ante | Attention: specify the door opening

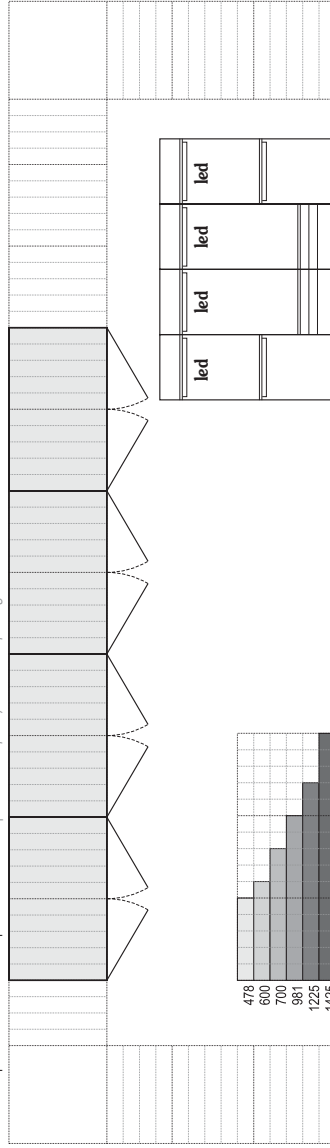

\*Solo per ripiani, cassettiere e divisioni interne tra ripiano e fondo  
Only for shelves, internal drawers and partitions between shelf and bottom

#### NOTE | NOTE

N. 2 cassettiere 2 cassetti + 1 cestone in dec. tessuto  
N. 4 lampade led, N. 6 ripiani, N. 6 tubi appendiabiti

No. 2 drawer units 2-draw + 1-deep draw dec. material  
No. 4 led lights, No. 6 shelves, No. 6 clothes hanger

#### FINITURA SCOCCA ESTERNA | EXTERNAL BODY FINISH

- Lacc. opaco | Matt lacq. grigio perla / pearl grey
- Essenza | Wood
- Rovere l. poro aperto | open pore lacq. oak
- Lacc. lucido | Glossy lacq.

#### FINITURA SCOCCA INTERNA | INTERNAL BODY FINISH

- Melaminico magnolia | Magnolia melamine
- Melam. decorativo tessuto | Decorative material melam.
- Lacc. opaco | Matt lacq.
- Melam. rovere termotrattato | heat-treated oak melam. \*

Cliente / Customer: \_\_\_\_\_  
 Provincia-Stato / Province-State: \_\_\_\_\_  
 Data / Date: \_\_\_\_\_  
 Riferimento / Reference: \_\_\_\_\_  
 Consegna / Delivery: \_\_\_\_\_

#### TIPOLOGIA ANTE | DOORS TYPE

- BASIC
  - ASOLA
  - LINEAR
  - DESIGN
  - SPRINT
  - SPRINT PLUS
  - SIMPLY
  - SIMPLY VETRO
  - TECNO \*
  - TECNO VETRO \*
  - GLASS
  - SLIDE
  - INCISA
  - ONDA
  - TECNO \*
  - COMPOSTA
  - COMPOSTA PLUS
  - GREEN
  - VERTICAL
  - RIGA
  - TELAIO "O" \*
  - TELAIO "A" \*
  - TELAIO "C" \*
  - TELAIO "D" \*
- \* Specificare la finitura telaio  
Specify frame finish

#### FINITURA ANTE | DOORS FINISH

- Sup. termofornata grigio perla  
thermoformed surf. pearl grey
- Lacc. opaco  
Matt. lacq.
- Essenza  
Wood
- Rovere l. poro aperto  
Open pore lacq. oak
- Lacc. lucido  
Glossy lacq.
- Rovere termotrattato  
Heat-treated oak
- Vetro o specchio  
Glass or mirror
- alto centrale  
up central
- basso centrale  
down central

#### FINITURA MANIGLIE | HANDLES FINISH

- ALFA
- GAMMA
- DELTA
- EPSILON
- BETA
- OMEGA
- LAMA H. 40
- LAMA H. 330
- VIP
- RETTA
- SERRATURA | LOCK



Gamma colori - *Colour range* P. **208**

## PROJECT con pannelli boiserie | *with boiserie panels*

Caratteristiche dimensionali | *Dimensional characteristics* P. **212**

Cremagliere e cornici terminali | *Racks and terminal frames* P. **218**

Pannelli boiserie | *Boiserie panels* P. **219**

## EASY PROJECT senza pannelli boiserie | *without boiserie panels*

Caratteristiche dimensionali | *Dimensional characteristics* P. **224**

Cremagliere | *Racks* P. **228**

## ATTREZZATURA | *EQUIPMENT*

Calcolo quantità staffe di supporto ripiani e staffe servetto estraibile  
*Calculating the quantity of shelf brackets and pull-down rail brackets* P. **230**

Staffa e ripiani | *Stirrup and shelves* P. **231**

Panca a terra | *Bench* P. **231**

Raster | *Raster* P. **232**

Porta scarpe sospeso | *Wall-hung shoe-rack* P. **232**

Cassettiere | *Set of drawers* P. **233**

Accessori estraibili | *Pullout accessories* P. **238**

Accessori | *Accessories* P. **239**

Soluzioni su misura | *Custom-sizing* P. **242**

Modulo ed esempio d'ordine | *Order form and example* P. **244**

Condizioni di vendita | *Conditions of sale* P. **248**

MELAMINICI | *MELAMINES* cat. 1



decorativo tessuto  
*decorative material*



rovere termotrattato  
*heat - treated oak*

MELAMINICI MATERICI | *TEXTURED MELAMINES* cat. 2



olmo bianco extra  
*extra white elm*



olmo beige  
*beige elm*

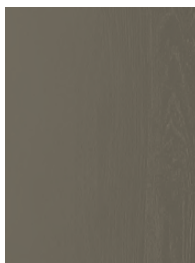

olmo taupe  
*taupe elm*

SPECCHI per pannelli boiserie | *MIRRORS for boiserie panels*



specchio  
*mirror*



specchio fumo  
*smoked mirror*

VETRO per frontali cassetti | *GLASS for front part of drawers*



trasparente  
*transparent*



## LACCATI OPACHI E LUCIDI | MATT AND GLOSSY LACQUERS



bianco 9003  
white



panna 9010  
light cream



fior di loto 1013  
lotus flower



crema 9001  
cream



senape 1024  
mustard



giallo zinco 135  
zinc yellow



giallo cromo 140  
chrome yellow



bruciato 173  
"burned" colour



biscotto 2010  
biscuit



rosso acceso 3001  
fiery red



rosso 3003  
red



rosso bordeaux 3005  
bordeaux red



verde pomplemo 192  
grapetruit green



verde muscio 198  
moss green



verde pallido 190  
pale green



verde petrolio 5021  
petrol green



verde finlandia 199  
Finland green



ghiaccio 9002  
ice



grigio perla 238  
pearl grey



grigio seta 7044  
silk grey



grigio garda 246  
Garda grey



argento 9006  
silver



grigio chiaro 7035  
light grey



grigio polvere 252  
powder grey



blu piombo 255  
gun metal blue



lilla 228  
lilac



tortora  
dove grey



canapa  
hemp



corda  
rope



grigio aston 7039  
aston grey



nero 9017  
black



light grey  
Y18231



dark grey  
Y18232

N.B.: La riproduzione dei colori su carta può risultare alterata rispetto agli originali, pertanto queste tinte sono da considerarsi puramente indicative.

N.B.: The reproduction of the colours on paper may be different with respect to the original colours, therefore these shades should be considered representative only.









## SCHEMA PER IL CALCOLO DELLE DIMENSIONI DELLA CABINA ARMADIO SCHEME FOR THE CALCULATION OF THE WALK-IN CLOSET DIMENSIONS

**Attenzione:** le cornici terminali vanno sempre a chiudere la composizione su entrambi i lati. In alternativa può essere usato un pannello boiserie di compensazione da tagliare a misura.

**Attention:** end cornices always finish the compositions on both sides. Alternatively, a custom-sized filler wall panel can be used.

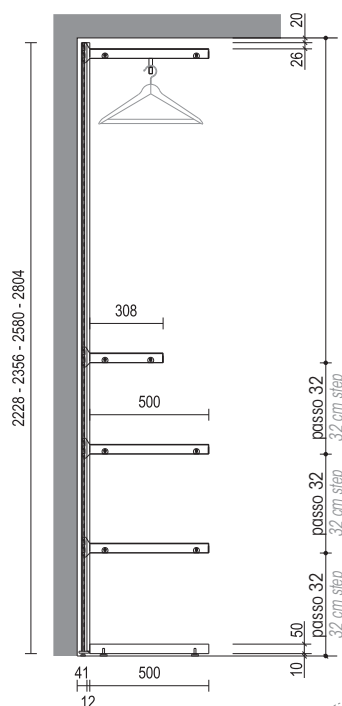
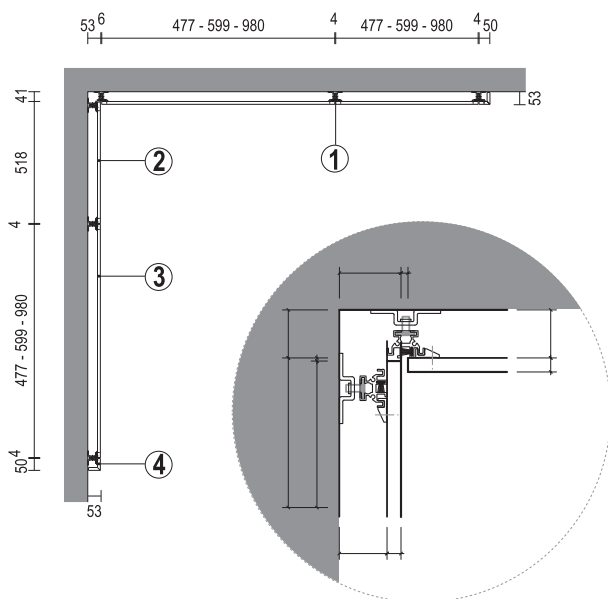

- 1 Cremagliera | Rack
- 2 Pannello boiserie per angolo | Boiserie panel for corner
- 3 Pannello boiserie | Boiserie panel
- 4 Cornice terminale | Terminal frame

### MODULI IN LARGHEZZA | MODULE IN WIDTH

477  
599  
980

### MODULI IN ALTEZZA | MODULE IN HEIGHT

2228  
2356  
2580  
2804

- Il sistema di aggancio delle staffe al profilo cremagliera consente il posizionamento di cassettiere, ripiani e raster all'altezza desiderata e con passo di 32 mm.
- La tenuta delle cremagliere, con la relativa attrezzatura è garantita dal corretto utilizzo dei tasselli, adeguati al tipo di parete (calcestruzzo, cartongesso, laterizio, ecc.) pertanto la responsabilità delle operazioni di montaggio è totalmente a carico del cliente.
- Spazio minimo di montaggio: H. 20 mm - L. 10 mm

- The fastening of the brackets on the rack profiles allows the assembly of the sets of drawers, shelves and raster units on the height needed and with a spacing of 32 mm.
- The sturdiness of the rack and of its accessories is ensured by using the right screw plugs suitable to the type of wall (concrete, plasterboard, brick, etc.) therefore the customer is solely responsible for assembly.
- Minimum space needed for the assembly: H. 20 mm - L. 10 mm

# PROJECT - CARATTERISTICHE DIMENSIONALI | DIMENSIONAL CHARACTERISTICS

## SCHEMA PER IL CALCOLO DELLE DIMENSIONI DELLA CABINA ARMADIO SCHEME FOR THE CALCULATION OF THE WALK-IN CLOSET DIMENSIONS

### Esempio composizione lineare Example of linear composition

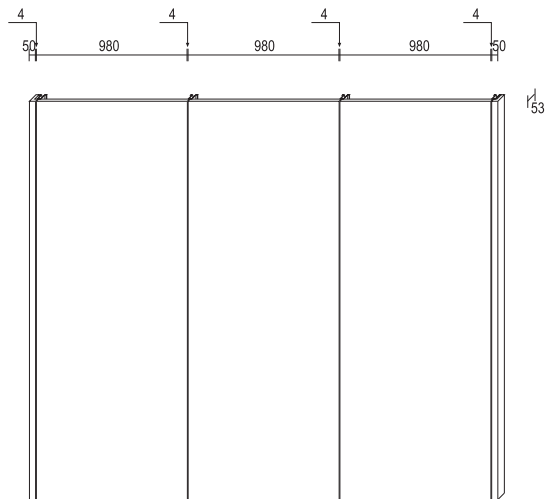

Es.:  $50 + 4 + 980 + 4 + 980 + 4 + 980 + 4 + 50 \text{ mm} = 3056 \text{ mm}$

### Esempio composizione ad angolo Example of corner composition

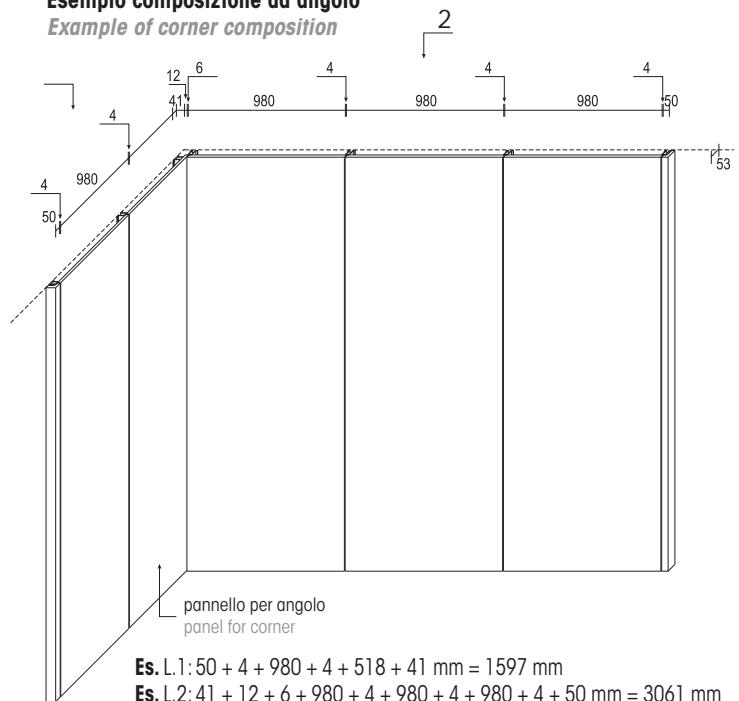

Es. L.1:  $50 + 4 + 980 + 4 + 518 + 41 \text{ mm} = 1597 \text{ mm}$

Es. L.2:  $41 + 12 + 6 + 980 + 4 + 980 + 4 + 980 + 4 + 50 \text{ mm} = 3061 \text{ mm}$

## CARATTERISTICHE TECNICHE CABINA CON PANNELLI BOISERIE "PROJECT"

### CREMAGLIERE:

Realizzate in alluminio naturale, con tre tipi di regolazione: in altezza tramite piedino posto sotto la cremagliera, in profondità con regolazione frontale coperta da spazzolino interno e laterale tramite le asole dei giunti fissati a parete. Presentano delle asole che garantiscono un facile aggancio degli accessori a passo 32 mm. in altezza.

### STAFFE:

Realizzate in metallo sp.3 mm con verniciatura epossidica finitura alluminio. Disponibili in due dimensioni: per ripiani con prof. 500 e 308.

### PANNELLI BOISERIE:

Sono realizzati in pannelli di particelle classe E1 sp.12 mm. Disponibili nelle finiture melaminico decorativo tessuto, melaminico finitura olmo nei colori bianco extra, beige e taupe, melaminico finitura rovere termotrattato, laccato opaco e lucido in tutta la gamma colori, con la possibilità di avere applicato specchio e specchio fumo. Per gli schienali Boiserie con specchio si consiglia di utilizzare almeno un ripiano. Predisposti con sistema di aggancio rapido a clips alle cremagliere.

### PANCHE E FONDI PER CASSETTIERE:

Sono realizzati in pannelli di particelle classe E1 sp.38 mm. nelle finiture melaminico finitura olmo nei colori bianco extra, beige e taupe, sp. 40 mm. nelle finiture melaminico decorativo tessuto, melaminico finitura rovere termotrattato, laccato opaco e lucido in tutta la gamma colori. Appoggiano su piedini h.10 regolabili in altezza.

### RIPIANI - COPERCHI PER CASSETTIERE:

Sono realizzati in pannelli di particelle classe E1 sp.38 mm. nelle finiture melaminico finitura olmo nei colori bianco extra, beige e taupe, sp. 40 mm. nelle finiture melaminico decorativo tessuto, melaminico finitura rovere termotrattato, laccato opaco e lucido in tutta la gamma colori. I ripiani sono agganciati alle cremagliere per mezzo delle staffe in metallo.

### CASSETTIERE:

Sono realizzati in pannelli di particelle classe E1 sp.19/20 mm. Disponibili nelle finiture melaminico decorativo tessuto, melaminico finitura olmo nei colori bianco extra, beige e taupe, melaminico finitura rovere termotrattato, laccato opaco e lucido in tutta la gamma colori. Previste con frontali legno o telaio con vetro trasparente, montati su guide ad estrazione parziale con chiusura ammortizzata. Non vengono utilizzate maniglie, la sua apertura avviene direttamente sul frontale. Le cassettiere si possono posizionare sospese (solo 2 cassetti), in appoggio su panche, fondi o ruote piroettanti.

### ACCESSORI:

Roster sospesi o in appoggio su ripiani, telai estraibili con portapantaloni, vassoio porta oggetti o portacravatte/cinture, ripiani portascarpe, aste appendiabiti, servetto, kit di illuminazione, gruccia in legno e scatole rivestite in tessuto completano ed arricchiscono l'attrezzatura interna della cabina Project.

### VERNICI E TOLLERANZE:

Le vernici utilizzate sono a basso residuo secco e atossiche. Per i laccati opachi il ciclo di verniciatura è ad acqua, mentre per i laccati lucidi a solvente. Esistono anche dei margini di tolleranza dovuti a variazione di prodotto per le finiture laccate. In caso di completamento successivo all'ordine, non si garantisce la perfetta eguaglianza di colori con la composizione originaria.

### ISTRUZIONI PER L'USO E LA PULIZIA:

Le superfici sono trattate per garantire una buona resistenza all'usura e al graffio. Per la pulizia e la manutenzione si consiglia di passare sulle superfici un panno morbido inumidito con acqua o eventualmente con aggiunta di detergenti neutri facilmente reperibili sul mercato. Non usare prodotti contenenti sostanze abrasive, alcol, ammoniaca o altri tipi di solventi. Si declina ogni responsabilità per inconvenienti dovuti all'uso di prodotti chimici e per usi impropri del prodotto (non utilizzare cassetti o altri elementi per scopi di natura impropria ad esempio come seduta o scala, non sovraccaricare cassettiere o ripiani con pesi eccessivi).

## TECHNICAL FEATURES OF THE "PROJECT" WALK-IN CLOSET WITH BACK PANELS

### RACKS:

Made from natural aluminium provided with three types of adjustments: in height by means of a foot at the base of the rack, in depth by a front adjustment device covered by the interior seal brush and side adjustment through the slots on the joints secured to the wall. They are provided with slots that ensure easy attachment of accessories at intervals of 32 mm in height.

### BRACKETS:

Made from 3 mm thick metal with an aluminium-effect epoxy finish. Available in 2 sizes: for 500 and 308 mm deep shelves.

### WALL PANELS:

Made from 12 mm thick, class E1 wood particleboard. Available with a fabric-effect melamine or an elm-effect melamine finish, in extra white, beige and taupe colours, in heat-treated oak effect melamine, in matt and gloss lacquers in the entire colour range and with the possibility of applying a plain mirror or a smoked glass mirror. It is advisable to use at least one shelf on mirrored wall panels. They are provided with a quick clip-on system to attach them to the rack.

### BENCHES AND DRAWER PACK BOTTOM PANELS:

They are made from class E1 particleboard which is 38 mm thick for the elm-effect melamine finish in the extra white, beige and taupe colours; 40 mm thick for fabric-effect melamine, heat-treated oak-effect melamine and for the matt and gloss lacquers of the entire colour range. They stand on height-adjustable, 10 mm high feet.

### SHELVES - DRAWER PACK TOPS:

They are made from class E1 particleboard which is 38 mm thick for the elm-effect melamine finish and for the extra white, beige and taupe colours; 40 mm thick for fabric-effect melamine and for the matt and gloss lacquers of the entire colour range. The shelves are attached to the racks by means of metal brackets.

### DRAWER PACKS:

Made from 19/20 mm thick, class E1 wood particleboard. Available with a fabric-effect melamine or elm-effect melamine finish, in extra white, beige and taupe colours, in heat-treated oak effect melamine, in matt and gloss lacquers in the entire colour range. Drawers are available with fronts in wood or framed with transparent glass and mounted on soft-close, partial extension runners. They are opened without the use of handles, by grasping the front panel. The drawer packs can be hung to the wall (only 2 drawers) or standing on benches, bottom panels or castors.

### ACCESSORIES:

Wall-hung shelving units or standing on shelves, pullout frames with trouser-racks, multi-purpose or tie/belt-rack trays, shoe-racks, hanging rails, pull-down rails, lighting kit, wooden coat hangers and fabric covered boxes complete the interior accessories of the Project walk-in closet.

### LACQUERS AND TOLERANCE MARGINS:

The lacquers used have a low quantity of dry residue and are non-toxic. The lacquering cycle is water-based for matt lacquers and solvent-based for gloss lacquers. For lacquer finishes there are tolerance margins due to product variations. In case of additions after the first order, it will not be possible to guarantee that the colours perfectly correspond to the original ones.

### MAINTENANCE AND CLEANING INSTRUCTIONS:

The surfaces are treated to ensure good resistance to wear and to scratches. For cleaning and maintenance purposes it is advisable to wipe the surfaces with a soft cloth moistened with water and, if necessary, with the addition of a neutral detergent easily available on the market. Do not use products containing abrasive substances, alcohol, ammonia or other types of solvents. We are not liable for inconveniences due to the use of chemical products or to improper use of the product (do not use drawers or other furniture parts to sit or stand on and do not overload drawer packs or shelves with exceedingly heavy objects).

## ESEMPIO DI COMPOSIZIONE DELLA CABINA ARMADIO EXAMPLE OF COMPOSITION OF WALK-IN CLOSETS

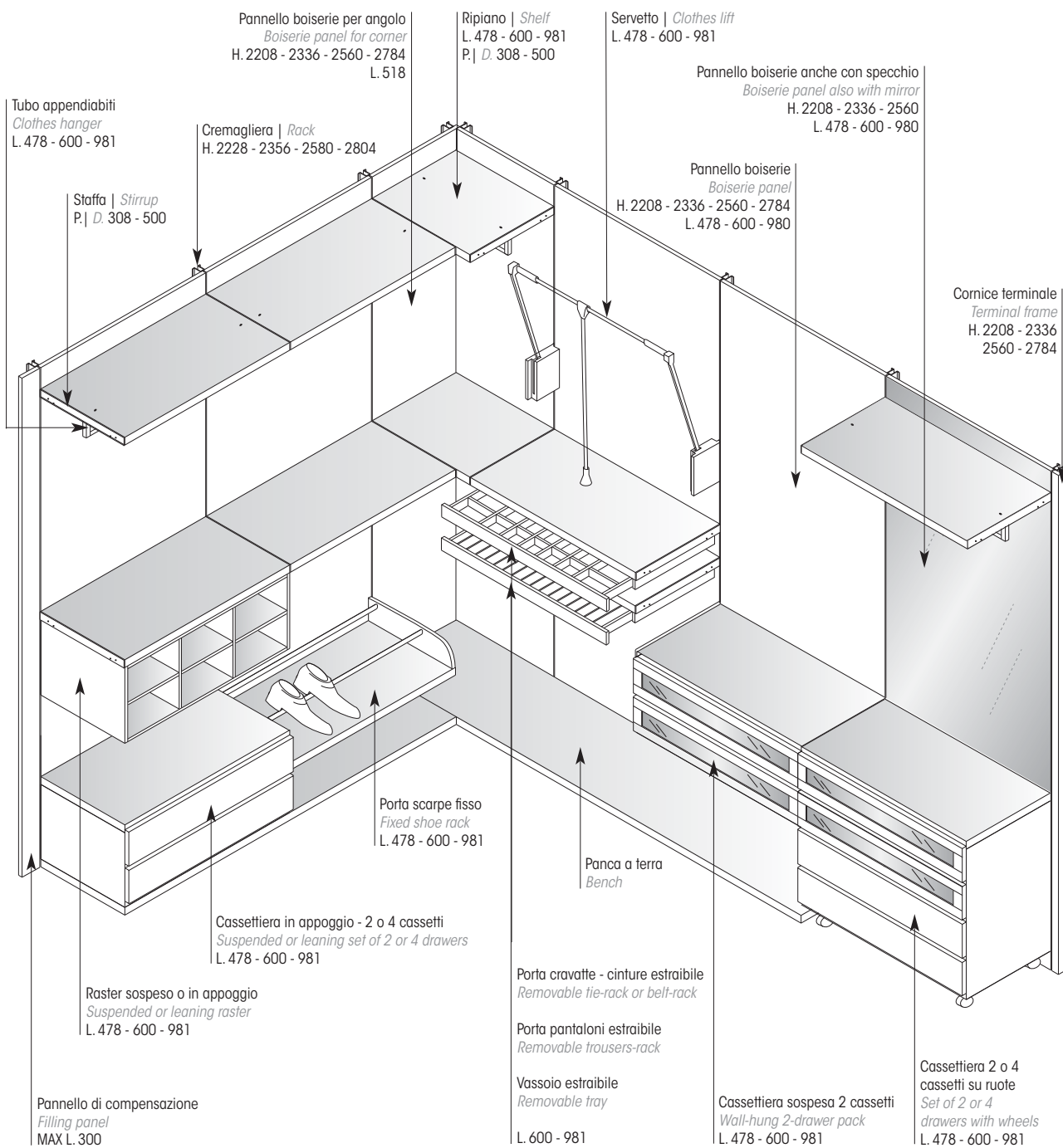

## SCHEMA PER IL CALCOLO DELLE DIMENSIONI DELLA CABINA ARMADIO IN CASO DI ANGOLI FUORI SQUADRA SCHEME TO CALCULATE THE WALK-IN CLOSET DIMENSIONS IN CASE OF OFF-SQUARE CORNERS

**Attenzione:** Rilevare con precisione le dimensioni dell'angolo. Nell'angolo fuorisquadra non è possibile mettere gli accessori.  
**Attention:** Map carefully the corner unit dimensions. No inner accessories can be inserted in slanted corner units (different from 90°).

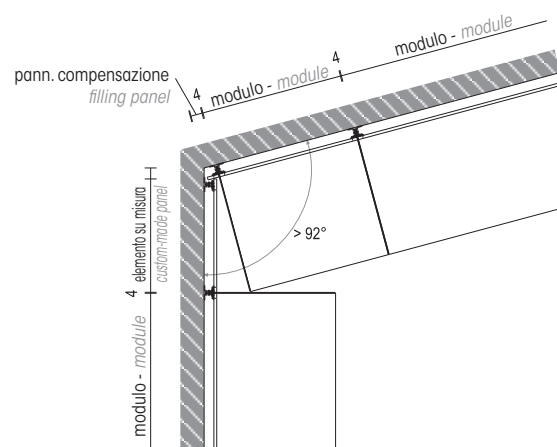
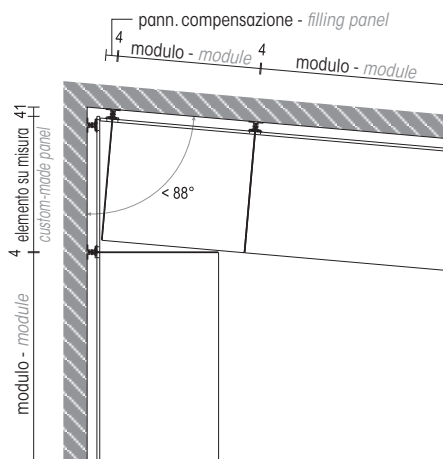
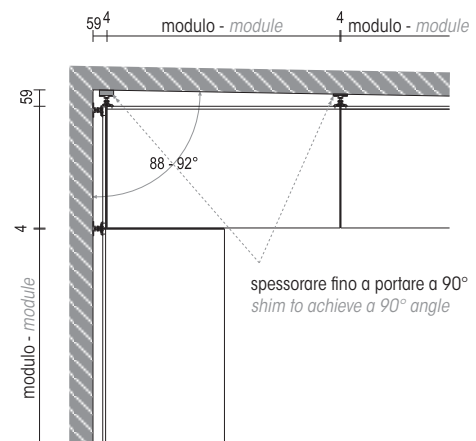
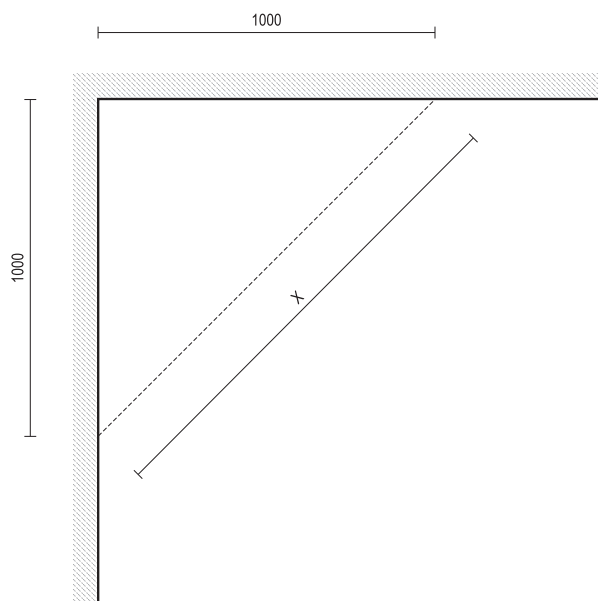

Prima di ordinare la cabina armadio opportuno fare un rilievo accurato delle pareti per verificare eventuali angoli fuori squadra.

**A un metro si distanzia dall'angolo misurare la diagonale (X).** Due pareti sono perpendicolari se la diagonale, misurata ad un metro di distanza dall'angolo è 1415 mm.

Il rilievo deve essere eseguito a diverse altezze, ma va posta particolare attenzione alla quota corrispondente ai ripiani.

*Measure off carefully the walls before ordering a walk-in closet, in order to map any slanted angles.*

**Calculate the diagonal (X) at a distance of 1 meter from the angle.** Two walls are perpendicular if the diagonal, measured off at a distance of 1 meter from the angle, is 1415 mm. The mapping shall be made at different heights, but with the utmost care for those heights corresponding to the shelf positions.

## ESEMPIO DI COMPONIBILITÀ LINEARE E CALCOLO DELLE PANCHE EXAMPLE OF IN-LINE ARRANGEMENTS AND HOW TO CALCULATE THE BENCHES

**Nel calcolo delle dimensioni in larghezza, è necessario considerare 10 mm di spazio tecnico libero per consentire il montaggio della cabina.**  
Le cornici terminali vanno sempre a chiudere la composizione su entrambi i lati terminali. In alternativa può essere usato un pannello boiserie di compensazione da tagliare a misura.

*When calculating the widths, an empty technical space of 10 mm must be left to assemble the closet.  
End frames always finish the arrangement on both sides. Alternatively, a custom-sized wall panel can be used.*

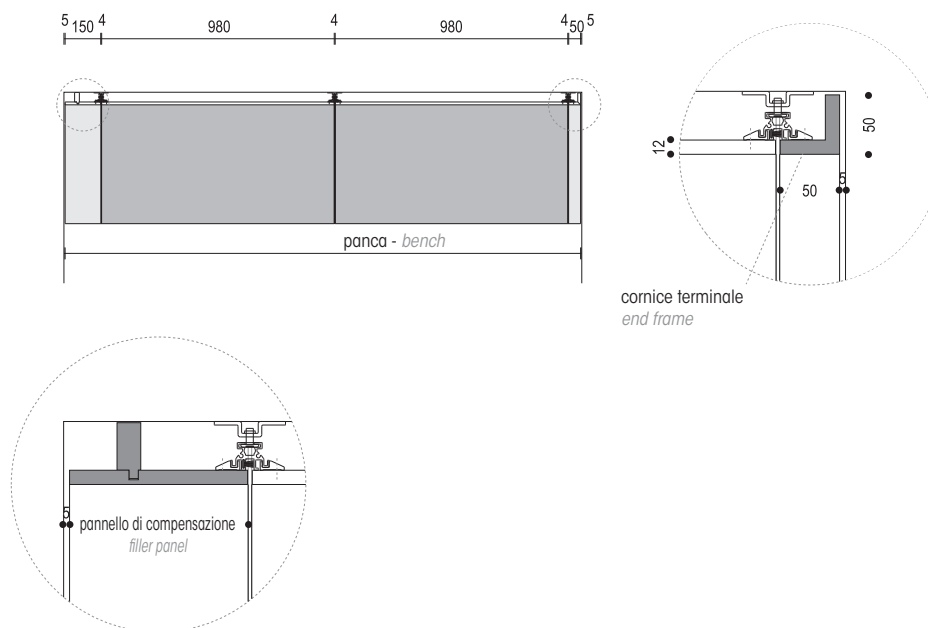

**Panca | Bench 1:**  $150 + 4 + 980 + 4 + 980 + 4 + 50$  mm = 2172 mm



## ESEMPIO DI COMPONENTI CON ANGOLI E CALCOLO DELLE PANCHE EXAMPLE OF ARRANGEMENTS WITH CORNERS AND HOW TO CALCULATE THE BENCHES

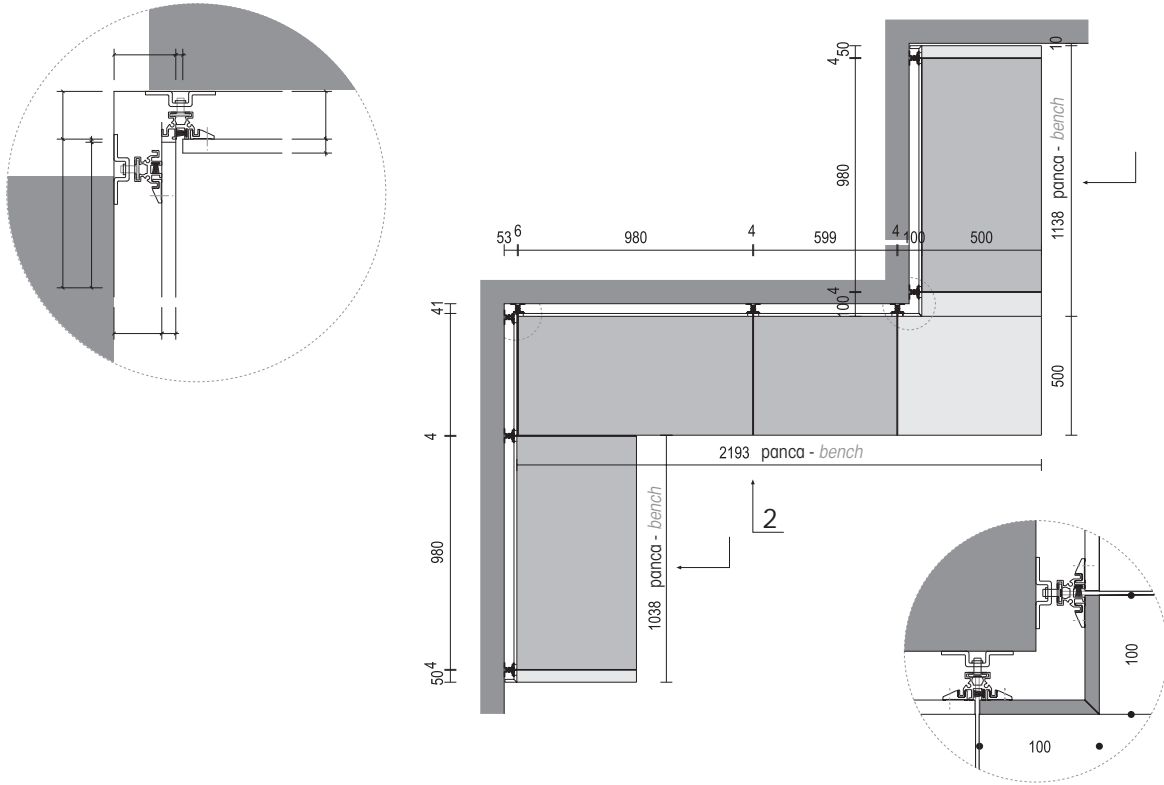

**Panca | Bench 1:**  $50 + 4 + 980 + 4 \text{ mm} = 1038 \text{ mm}$

**Panca | Bench 2:**  $6 + 980 + 4 + 599 + 4 + 100 + 500 \text{ mm} = 2193 \text{ mm}$

**Panca | Bench 3:**  $100 + 4 + 980 + 4 + 50 \text{ mm} = 1138 \text{ mm}$

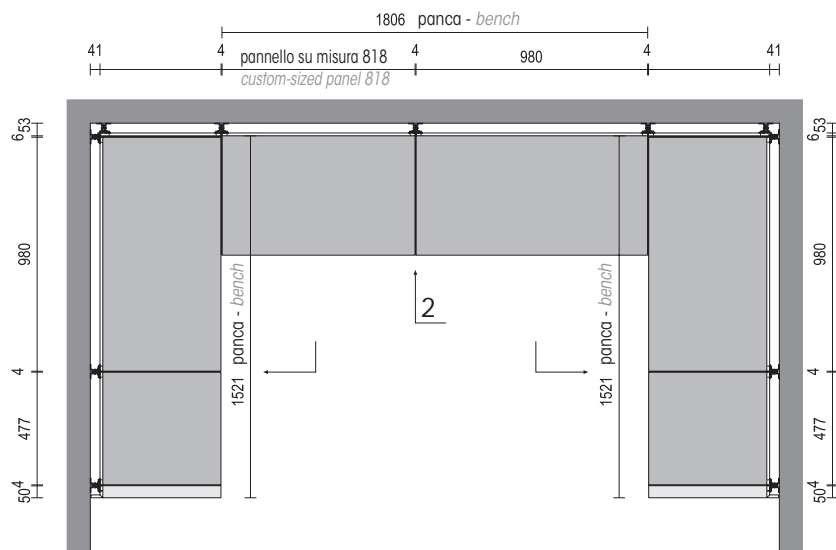

**Panca | Bench 1-3:**  $50 + 4 + 477 + 4 + 980 + 6 \text{ mm} = 1521 \text{ mm}$

**Panca | Bench 2:**  $4 + 818 + 4 + 980 \text{ mm} = 1806 \text{ mm}$

# PROJECT - CREMAGLIERE E CORNICI TERMINALI | RACKS AND TERMINAL FRAMES

## Cremagliere | Racks

Attenzione: nell'angolo devono essere posizionate N.2 cremagliere

Attention: 2 racks must be placed in the corner



Altezza Height	Codice Code	Finitura alluminio Aluminium finish				VOL. m <sup>3</sup> P. GR. W. Kg
H. 2228	PRXC1432	<b>82</b>				0,0035 m <sup>3</sup> 1,4 Kg
H. 2356	PRXC1433	<b>82</b>				0,0037 m <sup>3</sup> 1,5 Kg
H. 2580	PRXC1434	<b>90</b>				0,0041 m <sup>3</sup> 1,6 Kg
H. 2804	PRXC1435	<b>94</b>				0,0044 m <sup>3</sup> 1,8 Kg

## Cornici terminali | Terminal frames

L. 50 x P|D. 53

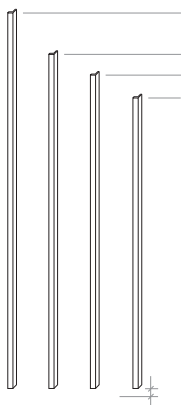

Altezza Height	Codice Code	Melaminico cat. 1 Melamine cat. 1	Melaminico cat. 2 Melamine cat. 2	Laccato opaco Matt lacq.	Laccato lucido Glossy lacq.	VOL. m <sup>3</sup> P. GR. W. Kg
H. 2208	PRT01552	<b>100</b>	<b>104</b>	<b>107</b>	<b>118</b>	0,0109 m <sup>3</sup> 1,9 Kg
H. 2336	PRT01553	<b>101</b>	<b>105</b>	<b>109</b>	<b>120</b>	0,0115 m <sup>3</sup> 2,0 Kg
H. 2560	PRT01554	<b>103</b>	<b>107</b>	<b>111</b>	<b>122</b>	0,0126 m <sup>3</sup> 2,2 Kg
H. 2784	PRT01555	<b>105</b>	<b>111</b>	<b>114</b>	<b>126</b>	0,0137 m <sup>3</sup> 2,3 Kg

## Cornici terminali per angolo | Terminal frames for corner

L. 100 x P|D. 100

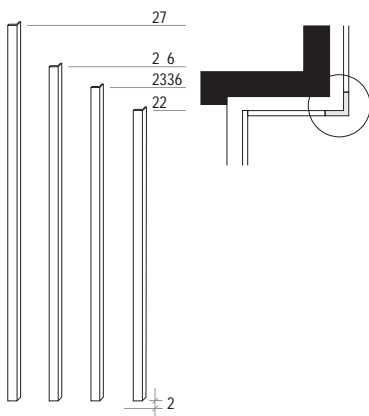

Altezza Height	Codice Code	Melaminico cat. 1 Melamine cat. 1	Melaminico cat. 2 Melamine cat. 2	Laccato opaco Matt lacq.	Laccato lucido Glossy lacq.	VOL. m <sup>3</sup> P. GR. W. Kg
H. 2208	PRT02112	<b>117</b>	<b>126</b>	<b>133</b>	<b>156</b>	0,0321 m <sup>3</sup> 3,7 Kg
H. 2336	PRT02113	<b>118</b>	<b>128</b>	<b>135</b>	<b>158</b>	0,0339 m <sup>3</sup> 3,9 Kg
H. 2560	PRT02114	<b>121</b>	<b>130</b>	<b>137</b>	<b>161</b>	0,0372 m <sup>3</sup> 4,3 Kg
H. 2784	PRT02115	<b>125</b>	<b>134</b>	<b>142</b>	<b>165</b>	0,0404 m <sup>3</sup> 4,7 Kg

# PROJECT - PANNELLI BOISERIE | BOISERIE PANELS

## Pannelli di compensazione | *Filling panel* Sp.|Th. 12 x L. 300

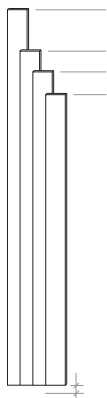

Altezza Height	Codice Code	Melaminico cat. 1 Melamine cat. 1	Melaminico cat. 2 Melamine cat. 2	Laccato opaco Matt lacq.	Laccato lucido Glossy lacq.	VOL. m <sup>3</sup> P. GR. W. Kg
H. 2208	PRB03232	<b>81</b>	<b>94</b>	<b>105</b>	<b>164</b>	0,0228 m <sup>3</sup> 6,8 Kg
H. 2336	PRB03233	<b>84</b>	<b>97</b>	<b>109</b>	<b>171</b>	0,0241 m <sup>3</sup> 7,2 Kg
H. 2560	PRB03234	<b>88</b>	<b>102</b>	<b>115</b>	<b>181</b>	0,0264 m <sup>3</sup> 7,9 Kg
H. 2784	PRB03235	<b>98</b>	<b>113</b>	<b>127</b>	<b>200</b>	0,0287 m <sup>3</sup> 8,6 Kg

## Pannelli boiserie | *Boiserie panel* Sp.|Th. 12 x L. 477

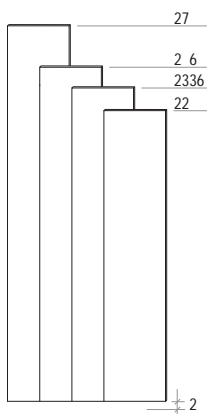

Altezza Height	Codice Code	Melaminico cat. 1 Melamine cat. 1	Melaminico cat. 2 Melamine cat. 2	Laccato opaco Matt lacq.	Laccato lucido Glossy lacq.	VOL. m <sup>3</sup> P. GR. W. Kg
H. 2208	PRB01242	<b>88</b>	<b>107</b>	<b>131</b>	<b>226</b>	0,0354 m <sup>3</sup> 8,8 Kg
H. 2336	PRB01243	<b>91</b>	<b>112</b>	<b>135</b>	<b>234</b>	0,0375 m <sup>3</sup> 9,4 Kg
H. 2560	PRB01244	<b>95</b>	<b>117</b>	<b>142</b>	<b>244</b>	0,0410 m <sup>3</sup> 10,3 Kg
H. 2784	PRB01245	<b>101</b>	<b>125</b>	<b>151</b>	<b>262</b>	0,0446 m <sup>3</sup> 11,2 Kg

## Pannelli boiserie | *Boiserie panel* Sp.|Th. 12 x L. 599

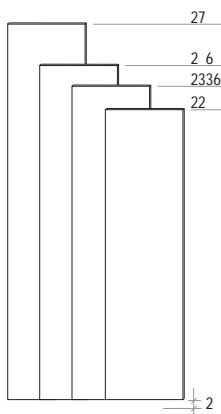

Altezza Height	Codice Code	Melaminico cat. 1 Melamine cat. 1	Melaminico cat. 2 Melamine cat. 2	Laccato opaco Matt lacq.	Laccato lucido Glossy lacq.	VOL. m <sup>3</sup> P. GR. W. Kg
H. 2208	PRB01262	<b>95</b>	<b>119</b>	<b>147</b>	<b>266</b>	0,0441 m <sup>3</sup> 11,1 Kg
H. 2336	PRB01263	<b>98</b>	<b>122</b>	<b>152</b>	<b>275</b>	0,0467 m <sup>3</sup> 11,8 Kg
H. 2560	PRB01264	<b>102</b>	<b>129</b>	<b>160</b>	<b>288</b>	0,0511 m <sup>3</sup> 12,9 Kg
H. 2784	PRB01265	<b>109</b>	<b>137</b>	<b>171</b>	<b>309</b>	0,0555 m <sup>3</sup> 14,0 Kg

# PROJECT - PANNELLI BOISERIE | BOISERIE PANELS

## Pannelli boiserie | Boiserie panel Sp.|Th. 12 x L. 980

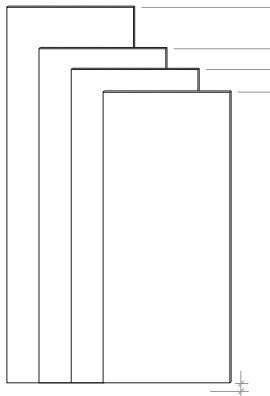

Altezza Height	Codice Code	Melaminico cat. 1 Melamine cat. 1	Melaminico cat. 2 Melamine cat. 2	Laccato opaco Matt lacq.	Laccato lucido Glossy lacq.	VOL. m <sup>3</sup> P. GR. W. Kg
H. 2208	PRB01292	<b>121</b>	<b>161</b>	<b>205</b>	<b>396</b>	0,0713 m <sup>3</sup> 18,2 Kg
H. 2336	PRB01293	<b>126</b>	<b>167</b>	<b>212</b>	<b>411</b>	0,0754 m <sup>3</sup> 19,2 Kg
H. 2560	PRB01294	<b>132</b>	<b>176</b>	<b>223</b>	<b>433</b>	0,0826 m <sup>3</sup> 21,1 Kg
H. 2784	PRB01295	<b>141</b>	<b>188</b>	<b>239</b>	<b>463</b>	0,0897 m <sup>3</sup> 22,9 Kg

## Pannelli boiserie per angolo | Boiserie panel for corner Sp.|Th. 12 x L. 515

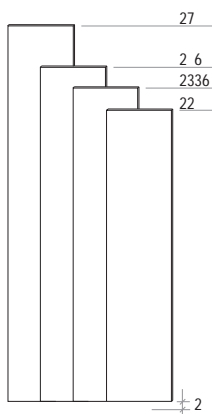

Altezza Height	Codice Code	Melaminico cat. 1 Melamine cat. 1	Melaminico cat. 2 Melamine cat. 2	Laccato opaco Matt lacq.	Laccato lucido Glossy lacq.	VOL. m <sup>3</sup> P. GR. W. Kg
H. 2208	PRB02252	<b>91</b>	<b>113</b>	<b>137</b>	<b>240</b>	0,0381 m <sup>3</sup> 9,6 Kg
H. 2336	PRB02253	<b>95</b>	<b>117</b>	<b>142</b>	<b>249</b>	0,0403 m <sup>3</sup> 10,1 Kg
H. 2560	PRB02254	<b>98</b>	<b>120</b>	<b>147</b>	<b>258</b>	0,0442 m <sup>3</sup> 11,1 Kg
H. 2784	PRB02255	<b>104</b>	<b>129</b>	<b>158</b>	<b>277</b>	0,0480 m <sup>3</sup> 12,0 Kg

## Pannelli boiserie con specchio | Boiserie panel with mirror Sp.|Th. 12 x L. 477

Non sono previste riduzioni a misura dei pannelli con specchio  
Panels with mirror cannot be cut

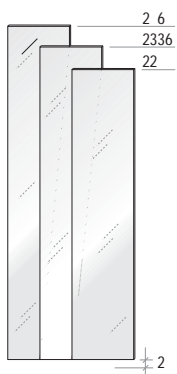

Altezza Height	Codice Code	Specchio Mirror	Specchio fumo Smoked mirror	VOL. m <sup>3</sup> P. GR. W. Kg
H. 2208	PRB11242	<b>211</b>	<b>239</b>	0,0354 m <sup>3</sup> 16,5 Kg
H. 2336	PRB11243	<b>221</b>	<b>250</b>	0,0375 m <sup>3</sup> 17,4 Kg
H. 2560	PRB11244	<b>235</b>	<b>267</b>	0,0410 m <sup>3</sup> 19,1 Kg

# PROJECT - PANNELLI BOISERIE | BOISERIE PANELS

## Pannelli boiserie con specchio | *Boiserie panel with mirror*

Sp.|Th. 12 x L. 599

Non sono previste riduzioni a misura dei pannelli con specchio

*Panels with mirror cannot be cut*

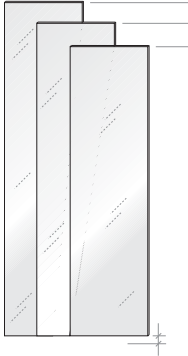

Altezza <i>Height</i>	Codice <i>Code</i>	Specchio <i>Mirror</i>	Specchio fumo <i>Smoked mirror</i>			VOL. m <sup>3</sup> P. GR. W. Kg
H. 2208	PRB11262	<b>243</b>	<b>278</b>			0,0441 m <sup>3</sup> 20,7 Kg
H. 2336	PRB11263	<b>254</b>	<b>290</b>			0,0467 m <sup>3</sup> 21,9 Kg
H. 2560	PRB11264	<b>272</b>	<b>312</b>			0,0511 m <sup>3</sup> 24,0 Kg

## Pannelli boiserie con specchio | *Boiserie panel with mirror*

Sp.|Th. 12 x L. 980

Non sono previste riduzioni a misura dei pannelli con specchio

*Panels with mirror cannot be cut*

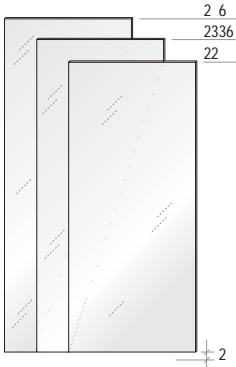

Altezza <i>Height</i>	Codice <i>Code</i>	Specchio <i>Mirror</i>	Specchio fumo <i>Smoked mirror</i>			VOL. m <sup>3</sup> P. GR. W. Kg
H. 2208	PRB11292	<b>349</b>	<b>406</b>			0,0713 m <sup>3</sup> 33,9 Kg
H. 2336	PRB11293	<b>366</b>	<b>425</b>			0,0754 m <sup>3</sup> 35,9 Kg
H. 2560	PRB11294	<b>394</b>	<b>460</b>			0,0826 m <sup>3</sup> 39,3 Kg

## Pannelli boiserie per angolo con specchio | *Boiserie panel for corner with mirror*

Sp.|Th. 12 x L. 515

Non sono previste riduzioni a misura dei pannelli con specchio

*Panels with mirror cannot be cut*

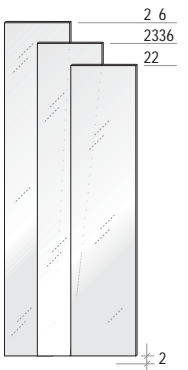

Altezza <i>Height</i>	Codice <i>Code</i>	Specchio <i>Mirror</i>	Specchio fumo <i>Smoked mirror</i>			VOL. m <sup>3</sup> P. GR. W. Kg
H. 2208	PRB12252	<b>227</b>	<b>258</b>			0,0381 m <sup>3</sup> 17,8 Kg
H. 2336	PRB12253	<b>237</b>	<b>270</b>			0,0403 m <sup>3</sup> 18,8 Kg
H. 2560	PRB12254	<b>253</b>	<b>288</b>			0,0442 m <sup>3</sup> 20,6 Kg





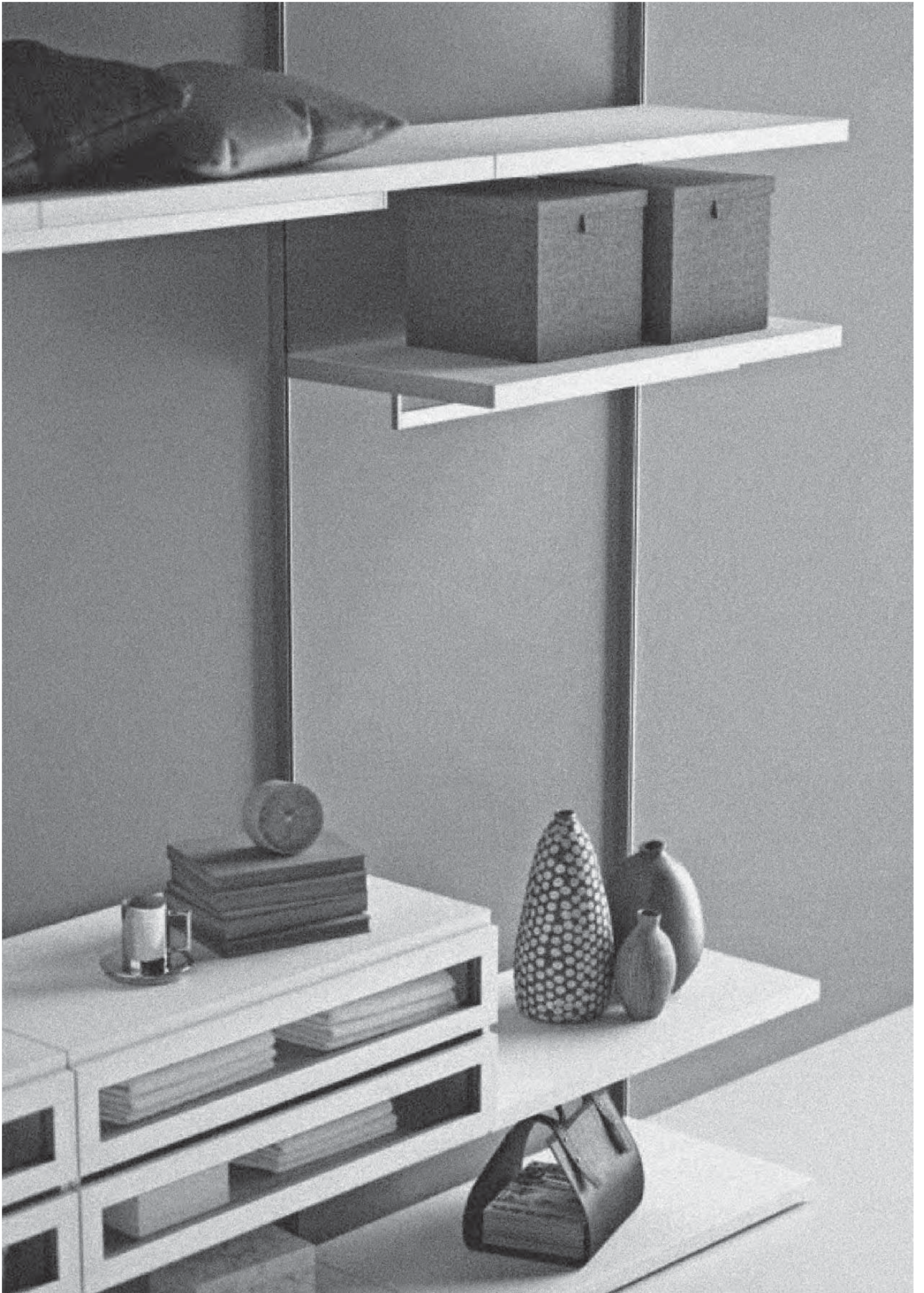



## SCHEMA PER IL CALCOLO DELLE DIMENSIONI DELLA CABINA SCHEME TO CALCULATE THE WALK-IN CLOSET DIMENSIONS

**Nel calcolo delle dimensioni in larghezza, è necessario considerare 10 mm di spazio tecnico libero per consentire il montaggio della cabina.**  
I ripiani e gli accessori rimangono distanziati dal muro 34 mm per lo spessore della cremagliera.  
**When calculating the widths, an empty technical space of 10 mm must be left to assemble the closet.**  
Shelves and accessories are fitted at a distance of 34 mm from the wall, which corresponds to the thickness of the rack.

### ESEMPIO COMPOSIZIONE H. 2580 EXAMPLE OF ARRANGEMENT H. 2580

DIMENSIONE MINIMA  
DI POSIZIONAMENTO  
MINIMUM SPACE REQUIREMENTS

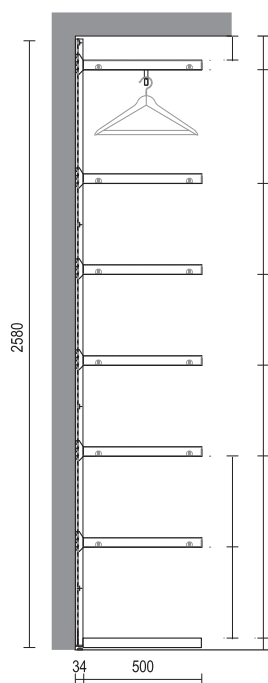

**POSIZIONI CONSIGLIATE  
PER AGGANCIAMENTO STAFFE  
SU CREMAGLIERA H.2580  
SENZA SCHIENALI**  
*RECOMMENDED POSITIONS TO  
ATTACH BRACKETS TO THE  
H.2580 RACK WITHOUT BACK  
PANELS*

DIMENSIONE MINIMA  
DI POSIZIONAMENTO  
MINIMUM SPACE REQUIREMENTS

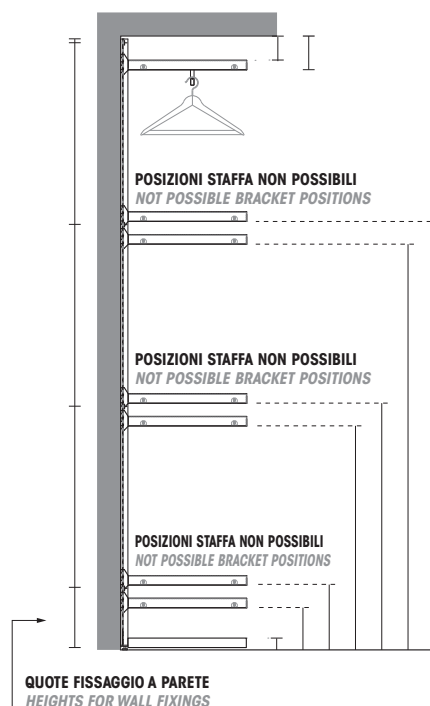

**POSIZIONI NON FATTIBILI  
PER AGGANCIAMENTO STAFFE  
SU CREMAGLIERA H. 2580  
SENZA SCHIENALI**  
*UNFEASIBLE POSITIONS TO ATTACH  
BRACKETS TO THE H. 2580  
RACK WITHOUT BACK PANELS*

#### MODULI IN LARGHEZZA MODULES IN WIDTH

478  
600  
981

#### MODULI IN ALTEZZA MODULES IN HEIGHT

2228  
2356  
2580  
2804

- Il sistema di aggancio delle staffe al profilo cremagliera consente il posizionamento di cassettiere, ripiani e raster con passo di 32 mm, tranne i punti indicati a disegno.
- La tenuta delle cremagliere, con la relativa attrezzatura è garantita dal corretto utilizzo dei tasselli, adeguati al tipo di parete (calcestruzzo, cartongesso, laterizio, ecc.), pertanto la responsabilità delle operazioni di montaggio è totalmente a carico del cliente.
- Spazio minimo di montaggio: H. 20 mm - L. 10 mm

- The system employed to fasten the brackets to the rack profiles allows the assembly of the drawer packs, shelves and shelving units at 32 mm intervals, except where indicated in the drawing.
- The sturdiness of the rack and of its accessories is ensured by using the right screw plugs suitable to the type of wall (concrete, plasterboard, brick, etc.) therefore the customer is solely responsible for assembly.
- Minimum space needed for the assembly: H. 20 mm - L. 10 mm



## ESEMPIO DI COMPONENTI E CALCOLO DELLE PANCHE EXAMPLE OF ARRANGEMENT AND HOW TO CALCULATE THE BENCHES

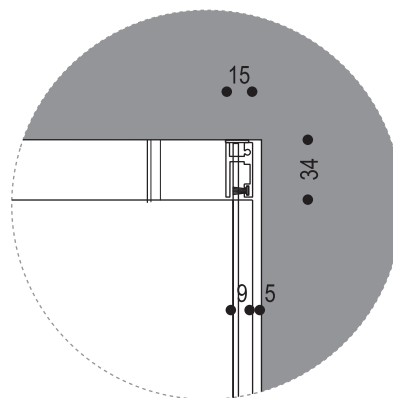
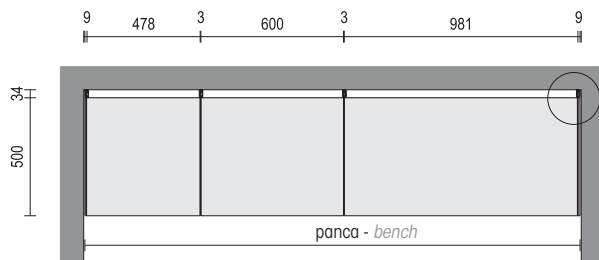

**Panca | Bench 1:**  $9 + 478 + 3 + 600 + 3 + 981 + 9 \text{ mm} = 2073 \text{ mm}$

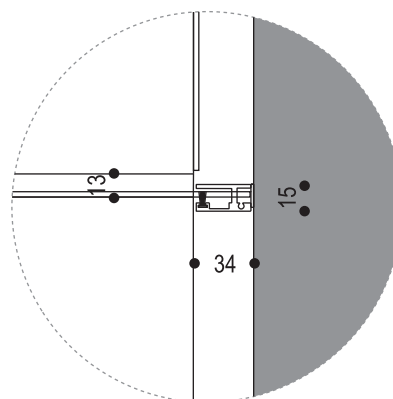
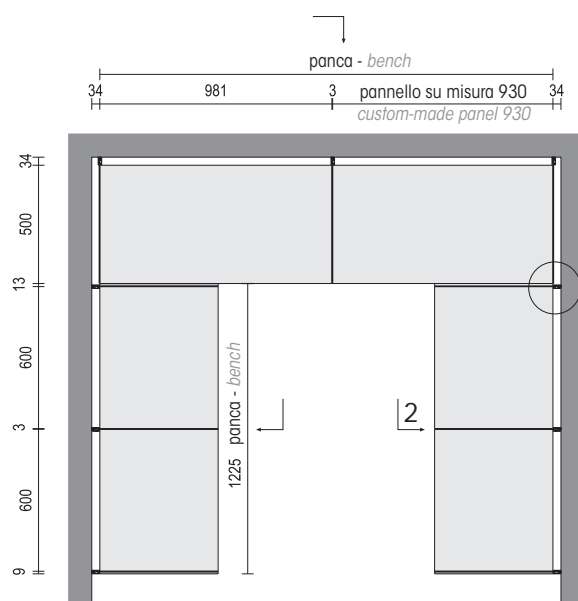

**Panca | Bench 1-2:**  $9 + 600 + 3 + 600 + 13 \text{ mm} = 1225 \text{ mm}$   
**Panca | Bench 3:**  $981 + 3 + 930 \text{ mm} = 1932 \text{ mm}$

## ESEMPIO DI COMPOSIZIONE DELLA CABINA ARMADIO SENZA PANNELLI BOISERIE EXAMPLE OF COMPOSITION WALK-IN CLOSETS WITHOUT BOISERIE PANEL

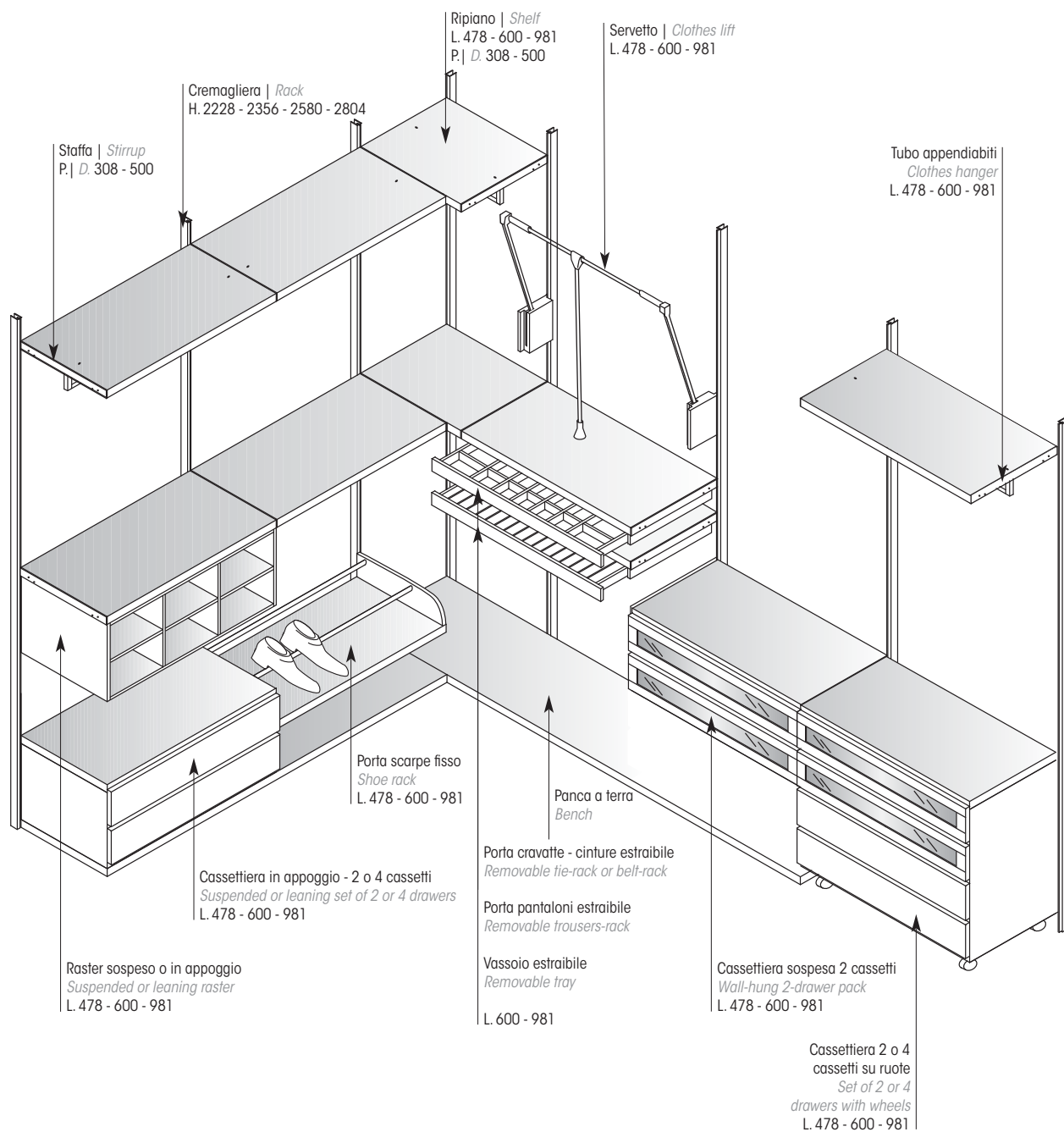

## SCHEMA PER IL CALCOLO DELLE DIMENSIONI DELLA CABINA ARMADIO IN CASO DI ANGOLI FUORI SQUADRA SCHEME TO CALCULATE THE WALK-IN CLOSET DIMENSIONS IN CASE OF OFF-SQUARE CORNERS

**Attenzione:** Rilevare con precisione le dimensioni dell'angolo. Nell'angolo fuorisquadra non è possibile mettere gli accessori.  
**Attention:** Map carefully the corner unit dimensions. No inner accessories can be inserted in slanted corner units (different from 90°).

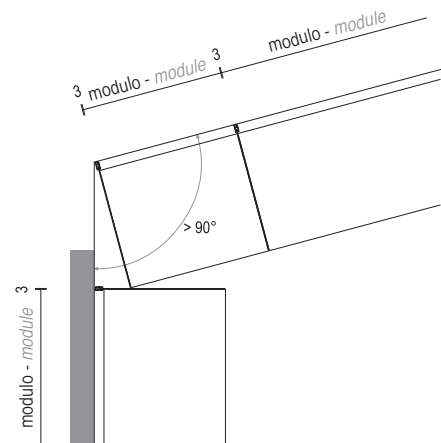
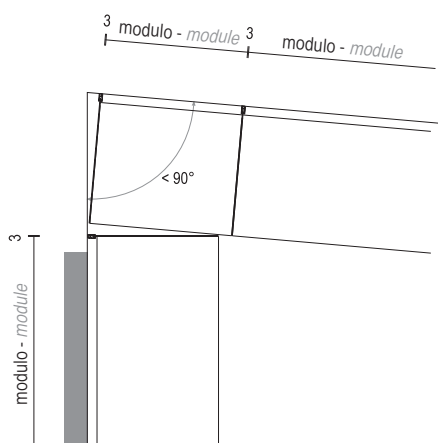
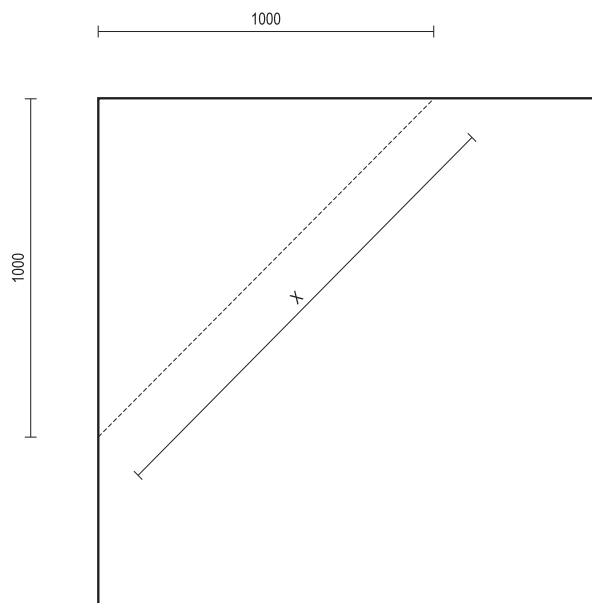

Prima di ordinare la cabina armadio opportuno fare un rilievo accurato delle pareti per verificare eventuali angoli fuori squadra.

**A un metro si distanzia dall'angolo misurare la diagonale (X).** Due pareti sono perpendicolari se la diagonale, misurata ad un metro di distanza dall'angolo è 1415 mm.

Il rilievo deve essere eseguito a diverse altezze, ma va posta particolare attenzione alla quota corrispondente ai ripiani.

*Measure off carefully the walls before ordering a walk-in closet, in order to map any slanted angles.*

**Calculate the diagonal (X) at a distance of 1 meter from the angle.** Two walls are perpendicular if the diagonal, measured off at a distance of 1 meter from the angle, is 1415 mm. The mapping shall be made at different heights, but with the utmost care for those heights corresponding to the shelf positions.

# EASY PROJECT - CREMAGLIERE | RACKS

## CARATTERISTICHE TECNICHE CABINA CON SCHIENALI "PROJECT"

### CREMAGLIERE:

Realizzate in alluminio naturale in finitura Argento Satinato, con due tipi di regolazione: in altezza tramite piedino posto sotto la cremagliera, in profondità con regolazione frontale coperta da spazzolino interno. Presentano delle asole che garantiscono un facile aggancio degli accessori a passo 32 mm. in altezza. Attenzione nei punti in cui si trova il sistema di regolazione in profondità e il fissaggio al muro, non si possono agganciare le staffe. Per migliori chiarimenti vedi disegni illustrativi Caratteristiche Dimensionali.

### STAFFE:

Realizzate in metallo sp.3mm.3 con verniciatura epossidica finitura alluminio. Disponibili in due dimensioni: per ripiani con prof. 500 e 308.

### PANCHE E FONDI PER CASSETTIERE:

Sono realizzati in pannelli di particelle classe E1 sp.38 mm. nelle finiture melaminico finitura olmo nei colori bianco extra, beige e taupe, sp. 40 mm. nelle finiture melaminico decorativo tessuto, melaminico finitura rovere termotrattato, laccato opaco e lucido in tutta la gamma colori. Appoggiano su piedini h.10 regolabili in altezza.

### RIPIANI - COPERCHI PER CASSETTIERE:

Sono realizzati in pannelli di particelle classe E1 sp.38 mm. nelle finiture melaminico finitura olmo nei colori bianco extra, beige e taupe, sp. 40 mm. nelle finiture melaminico decorativo tessuto, melaminico finitura rovere termotrattato, laccato opaco e lucido in tutta la gamma colori.

I ripiani sono agganciati alle cremagliere per mezzo delle staffe in metallo.

### CASSETTIERE:

Sono realizzati in pannelli di particelle classe E1 sp.19/20 mm.

Disponibili nelle finiture melaminico decorativo tessuto, melaminico finitura olmo nei colori bianco extra, beige e taupe, melaminico finitura rovere termotrattato, laccato opaco e lucido in tutta la gamma colori.

Previste con frontali legno o telaio con vetro trasparente, montati su guide ad estrazione parziale con chiusura ammortizzata. Non vengono utilizzate maniglie, la sua apertura avviene direttamente sul frontale.

Le cassettiere si possono posizionare sospese (solo 2 cassette), in appoggio su panche, fondi o ruote piroettanti.

### ACCESSORI:

Roster sospesi o in appoggio su ripiani, telai estraibili con portapantaloni, vassoio porta oggetti o portacravatte/cinture, ripiani portascarpe, aste appendiabiti, servetto, kit di illuminazione, gruccia in legno e scatole rivestite in tessuto completano ed arricchiscono l'attrezzatura interna della cabina Easy Project.

### VERNICI E TOLLERANZE:

Le vernici utilizzate sono a basso residuo secco e atossiche. Per i laccati opachi il ciclo di verniciatura è ad acqua, mentre per i laccati lucidi a solvente.

Esistono anche dei margini di tolleranza dovuti a variazioni di prodotto per le finiture laccate. In caso di completamento successivo all'ordine, non si garantisce la perfetta eguaglianza di colori con la composizione originaria.

### ISTRUZIONI PER L'USO E LA PULIZIA:

Le superfici sono trattate per garantire una buona resistenza all'usura e al graffio. Per la pulizia e la manutenzione si consiglia di passare sulle superfici un panno morbido inumidito con acqua o eventualmente con aggiunto di detersivi neutri facilmente reperibili sul mercato. Non usare prodotti contenenti sostanze abrasive, alcool, ammoniaca o altri tipi di solventi.

Si declina ogni responsabilità per inconvenienti dovuti all'uso di prodotti chimici e per usi impropri del prodotto (non utilizzare cassette o altri elementi per scopi di natura impropria ad esempio come seduta o scala, non sovraccaricare cassettiere o ripiani con pesi eccessivi).

## TECHNICAL FEATURES OF THE "PROJECT" WALK-IN CLOSET WITH BACK PANELS

### RACKS:

Made from Satin Silver finish natural aluminium with two types of adjustments: in height by means of a foot at the base of the rack, in depth by a front adjusting device covered by the interior seal brush. They are provided with slots that ensure easy attachment of accessories at intervals of 32 mm in height.

Please note that the brackets cannot be attached to the areas dedicated to depth adjustment and wall fixing. For more details please consult the drawings in the Dimensional Specifications section.

### BRACKETS:

Made from 3 mm thick metal with an aluminium-effect epoxy finish.

They are available in two sizes: for 500 and 308 mm deep shelves.

### BENCHES AND DRAWER PACK BOTTOM PANELS:

They are made from class E1 particleboard which is 38 mm thick for the elm-effect melamine finish in the extra white, beige and taupe colours; 40 mm thick for fabric-effect melamine, heat-treated oak-effect melamine and for the matt and gloss lacquers of the entire colour range.

They stand on height-adjustable, 10 mm high feet.

### SHELVES - DRAWER PACK TOPS:

They are made from class E1 particleboard which is 38 mm thick for the elm-effect melamine finish in the extra white, beige and taupe colours; 40 mm thick for fabric-effect melamine, heat-treated oak-effect melamine and for the matt and gloss lacquers of the entire colour range.

The shelves are attached to the racks by means of metal brackets.

### DRAWER PACKS:

Made from 19/20 mm thick, class E1 wood particleboard.

Available with a fabric-effect melamine or elm-effect melamine finish, in extra white, beige and taupe colours, in heat-treated oak effect melamine, in matt and gloss lacquers in the entire colour range.

Drawers are available with fronts in wood or framed with transparent glass and mounted on soft-close, partial extension runners. They are opened without the use of handles, by grasping the front panel.

The drawer packs can be hung to the wall (with 2 drawers) or standing on benches, bottom panels or castors.

### ACCESSORIES:

Wall-hung shelving units or standing on shelves, pullout frames with trouser-racks, multi-purpose or tie/belt-rack trays, shoe-racks, hanging rails, pull-down rails, lighting kit, wooden coat hangers and fabric covered boxes complete the interior accessories of the Easy Project walk-in closet.

### LACQUERS AND TOLERANCE MARGINS:

The lacquers used have a low quantity of dry residue and are non-toxic. The lacquering cycle is water-based for matt lacquers and solvent-based for gloss lacquers.

For lacquer finishes there are tolerance margins due to product variations. In case of additions after the first order, it will not be possible to guarantee that the colours perfectly correspond to the original ones.

### MAINTENANCE AND CLEANING INSTRUCTIONS:

The surfaces are treated to ensure good resistance to wear and to scratches. For cleaning and maintenance purposes it is advisable to wipe the surfaces with a soft cloth moistened with water and, if necessary, with the addition of a neutral detergent easily available on the market. Do not use products containing abrasive substances, alcohol, ammonia or other types of solvents. We are not liable for inconveniences due to the use of chemical products or to improper use of the product (do not use drawers or other furniture parts to sit or stand on and do not overload drawer packs or shelves with exceedingly heavy objects).

## Cremagliere | Racks



Altezza Height	Codice Code	Finitura alluminio Aluminium finish			VOL. m <sup>3</sup> P.   GR. W. Kg
H. 2228	PRXC3312	<b>82</b>			0,0035 m <sup>3</sup> 1,1 Kg
H. 2356	PRXC3313	<b>82</b>			0,0037 m <sup>3</sup> 1,2 Kg
H. 2580	PRXC3314	<b>90</b>			0,0041 m <sup>3</sup> 1,3 Kg
H. 2804	PRXC3315	<b>94</b>			0,0044 m <sup>3</sup> 1,4 Kg



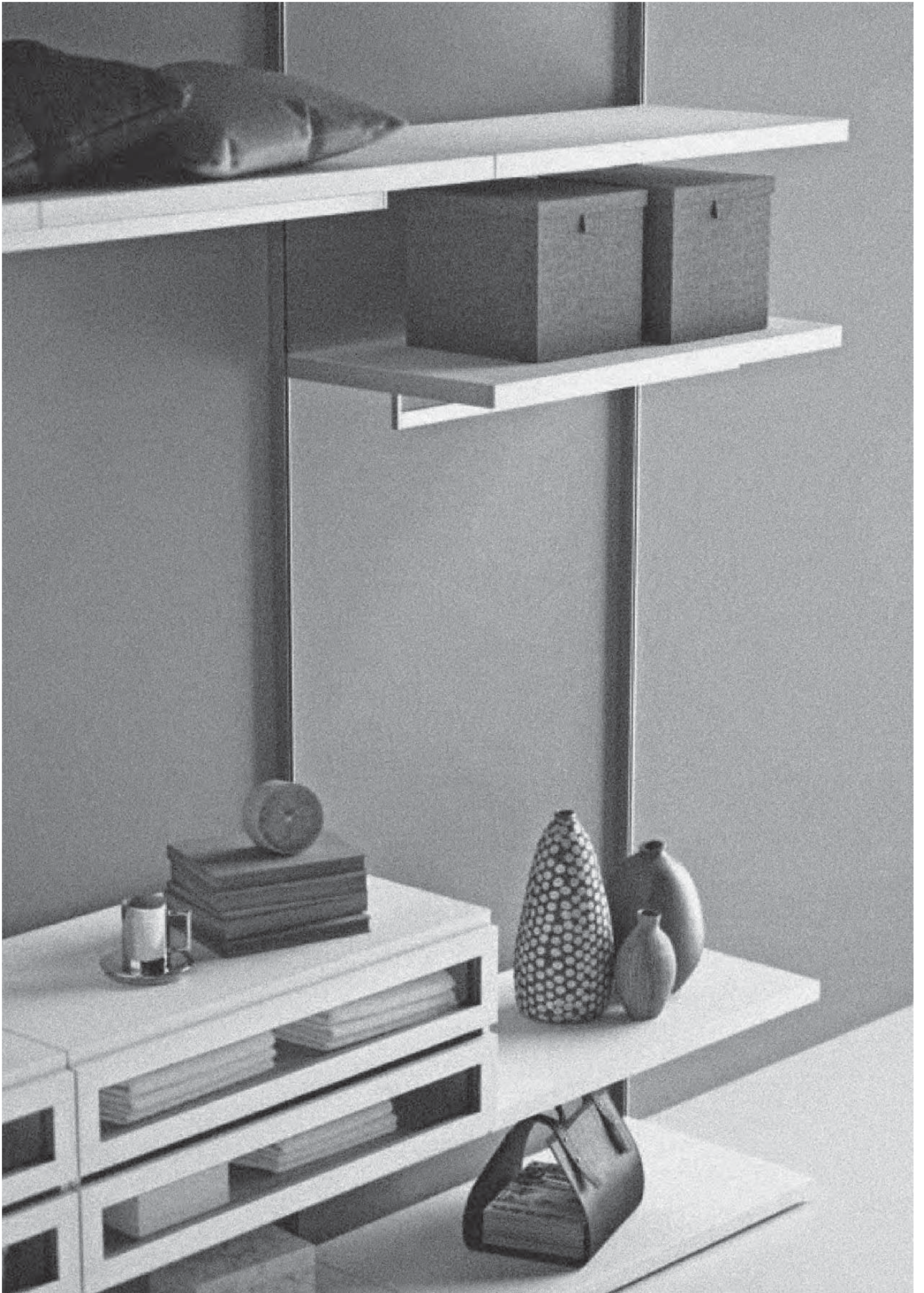



# PROJECT | EASY PROJECT - CALCOLO QUANTITÀ STAFFE SUPPORTO RIPIANI E STAFFE SERVETTO ESTENSIBILE CALCULATING THE QUANTITY OF SHELF BRACKETS AND OF PULL-DOWN RAIL BRACKETS

## CALCOLO QUANTITÀ STAFFE SUPPORTO RIPIANI E STAFFE SERVETTO ESTENSIBILE CALCULATING THE QUANTITY OF SHELF BRACKETS AND PULL-DOWN RAIL BRACKETS

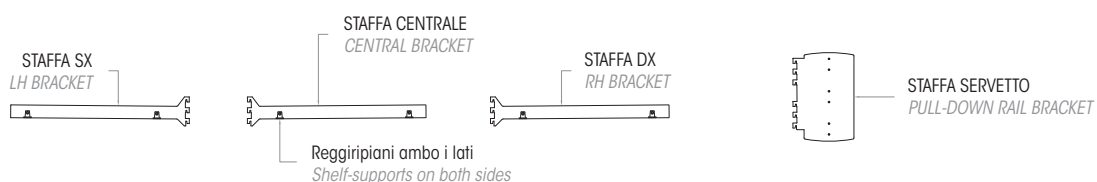
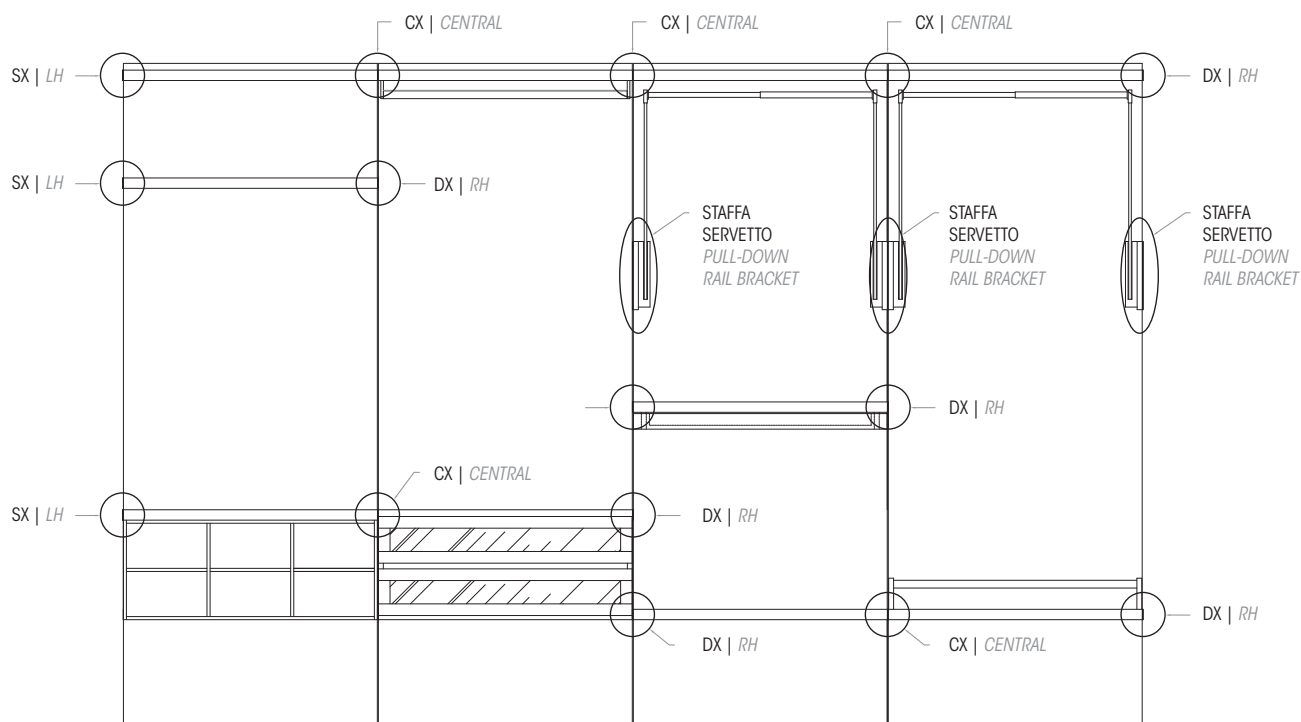

### CALCOLO QUANTITÀ STAFFE. CALCULATING THE QUANTITY OF BRACKETS.

TOTALE STAFFE PER SUPPORTI RIPIANI = N° 15  
TOTAL BRACKETS TO SUPPORT THE SHELVES = N° 15

TOTALE STAFFE PER SERVETTO = N° 3  
TOTAL BRACKETS FOR PULL-DOWN RAIL = N° 3

## Staffa | Stirrup

Le staffe vengono inserite su ripiani, raster sospesi, portascarpe e cassettiere sospese. Calcolare le quantità di staffe da ordinare (vedi esempio a pag. 230).  
The brackets are fitted on shelves, wall-hung shelving units, shoe-racks and wall-hung drawer packs. Calculate the quantity of brackets to order (see example on page. 230).

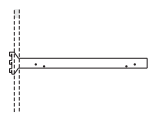

Profondità Depth	Codice Code	Finitura alluminio Aluminium finish				VOL. m <sup>3</sup> P. GR. W. Kg
308	PRXS1348	<b>18</b>				0,0006 m <sup>3</sup> 0,3 Kg
500	PRXS1358	<b>21</b>				0,0009 m <sup>3</sup> 0,5 Kg

## Ripiani | Shelves Sp.|Th. 38/40

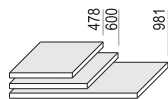

P.   D. 308	Larghezza Width	Codice Code	Melaminico cat. 1	Melaminico cat. 2	Laccato opaco	Laccato lucido	VOL. m <sup>3</sup> P. GR. W. Kg
			Melamine cat. 1	Melamine cat. 2	Matt lacq.	Glossy lacq.	
	L. 478	PRR01341	<b>34</b>	<b>37</b>	<b>45</b>	<b>59</b>	0,0098 m <sup>3</sup> 3,7 Kg
	L. 600	PRR01361	<b>38</b>	<b>42</b>	<b>53</b>	<b>70</b>	0,0122 m <sup>3</sup> 4,7 Kg
	L. 981	PRR01391	<b>53</b>	<b>60</b>	<b>78</b>	<b>105</b>	0,0197 m <sup>3</sup> 7,6 Kg

P.   D. 500	Larghezza Width	Codice Code	Melaminico cat. 1	Melaminico cat. 2	Laccato opaco	Laccato lucido	VOL. m <sup>3</sup> P. GR. W. Kg
			Melamine cat. 1	Melamine cat. 2	Matt lacq.	Glossy lacq.	
	L. 478	PRR01541	<b>42</b>	<b>48</b>	<b>61</b>	<b>83</b>	0,0155 m <sup>3</sup> 6,0 Kg
	L. 600	PRR01561	<b>47</b>	<b>53</b>	<b>71</b>	<b>99</b>	0,0193 m <sup>3</sup> 7,6 Kg
	L. 981	PRR01591	<b>66</b>	<b>76</b>	<b>105</b>	<b>149</b>	0,0312 m <sup>3</sup> 12,4 Kg

## Panche a terra Sp.38/40 con piedini regolabili H. 10

Benches Th. 38/40 with adjustable feet H. 10

P|D. 308/500

Lunghezza massima 3000 mm per laccato, melaminico decorativo tessuto e rovere termotrattato.  
Lunghezza massima 2700 mm per melaminico olmo. Per il calcolo della lunghezza vedi pag. 10-11-19  
Maximum length is 3000 mm for lacquers, fabric-effect and heat-treated oak melamine.  
Maximum length is 2700 mm for elm melamine. To calculate the length, check pages 10-11-19.



P.   D. 308	Lunghezza Length	Codice Code	Melaminico cat. 1	Melaminico cat. 2	Laccato opaco	Laccato lucido	VOL. m <sup>3</sup> P. GR. W. Kg
			Melamine cat. 1	Melamine cat. 2	Matt lacq.	Glossy lacq.	
	al metro - per LM	PRP40331	<b>119</b>	<b>133</b>	<b>145</b>	<b>200</b>	0,0201 m <sup>3</sup> 7,8 Kg
	al metro - per LM	PRP40531	<b>137</b>	<b>152</b>	<b>166</b>	<b>229</b>	0,0318 m <sup>3</sup> 12,6 Kg

# PROJECT | EASY PROJECT - RASTER E PORTA SCARPE | RASTER AND SHOE RACK

## Raster in appoggio | *Leaning raster* H. 384 x P/D. 500

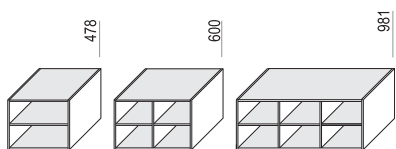

Larghezza Width	Codice Code	Melaminico cat. 1 <i>Melamine cat. 1</i>	Melaminico cat. 2 <i>Melamine cat. 2</i>	Laccato opaco <i>Matt lacq.</i>	Laccato lucido <i>Glossy lacq.</i>	VOL. m <sup>3</sup> P. GR. W. Kg
L. 478	PRR30543	<b>118</b>	<b>137</b>	<b>201</b>	<b>313</b>	0,111 m <sup>3</sup> 10 Kg
L. 600	PRR30563	<b>149</b>	<b>174</b>	<b>258</b>	<b>410</b>	0,138 m <sup>3</sup> 13 Kg
L. 981	PRR30593	<b>193</b>	<b>231</b>	<b>381</b>	<b>580</b>	0,222 m <sup>3</sup> 19 Kg

## Raster sospeso | *Suspended raster* H. 424 x P/D. 500

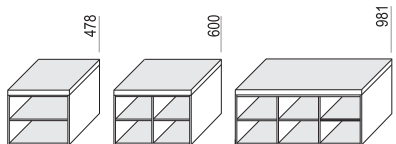

Larghezza Width	Codice Code	Melaminico cat. 1 <i>Melamine cat. 1</i>	Melaminico cat. 2 <i>Melamine cat. 2</i>	Laccato opaco <i>Matt lacq.</i>	Laccato lucido <i>Glossy lacq.</i>	VOL. m <sup>3</sup> P. GR. W. Kg
L. 478	PRR31544	<b>185</b>	<b>208</b>	<b>285</b>	<b>418</b>	0,127 m <sup>3</sup> 16 Kg
L. 600	PRR31564	<b>220</b>	<b>251</b>	<b>353</b>	<b>529</b>	0,158 m <sup>3</sup> 20 Kg
L. 981	PRR31594	<b>283</b>	<b>330</b>	<b>509</b>	<b>749</b>	0,253 m <sup>3</sup> 31 Kg

## Porta scarpe sospeso | *Wall-hung shoe-rack* H. 160 x P/D. 500

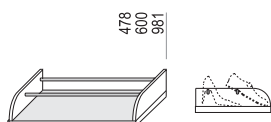

Larghezza Width	Codice Code	Melaminico cat. 1 <i>Melamine cat. 1</i>	Melaminico cat. 2 <i>Melamine cat. 2</i>	Laccato opaco <i>Matt lacq.</i>	Laccato lucido <i>Glossy lacq.</i>	VOL. m <sup>3</sup> P. GR. W. Kg
L. 478	PRR03541	<b>113</b>	<b>120</b>	<b>142</b>	<b>179</b>	0,0466 m <sup>3</sup> 7,6 Kg
L. 600	PRR03561	<b>125</b>	<b>133</b>	<b>156</b>	<b>198</b>	0,0580 m <sup>3</sup> 9,2 Kg
L. 981	PRR03591	<b>151</b>	<b>163</b>	<b>196</b>	<b>254</b>	0,0937 m <sup>3</sup> 14,1 Kg



**ESEMPIO DI COMPONIBILITÀ E POSIZIONAMENTO CASSETTIERE**  
**EXAMPLE OF DRAWER PACK ARRANGEMENTS AND POSITIONS**

**Le cassettiere sono disponibili con frontali tutti legno, vetro o misti legno e vetro.**

Solo le cassettiere in appoggio possono essere sovrapposte tra loro per comporre un numero superiore di cassetti, chiudendo sempre la composizione con il Top.

Le cassettiere in appoggio sono posizionabili su panche oppure a terra mediante ruote o fondo, mantenendo comunque l'allineamento con gli altri accessori.

Le cassettiere sospese sono fissate al ripiano top Sp.40mm agganciato tramite staffe al sistema cremagliera.

Tutte le cassettiere montano guide ad estrazione parziale con sistema di chiusura ammortizzato.

**The drawer packs are available with all-wood, glass or a combination of wood and glass fronts.**

Only standing drawer packs can be fitted one on top of the other to achieve units with a greater number of drawers. A top has always to be added.

The standing drawer packs can be placed on benches, or on the floor with castors or on a bottom panel. All these versions will be aligned with the other accessories.

The wall-hung drawer packs are fixed to a 40 mm thick top that is secured to the rack system by means of a bracket.

All the drawer packs are provided with partial-extension runners with a soft-close system

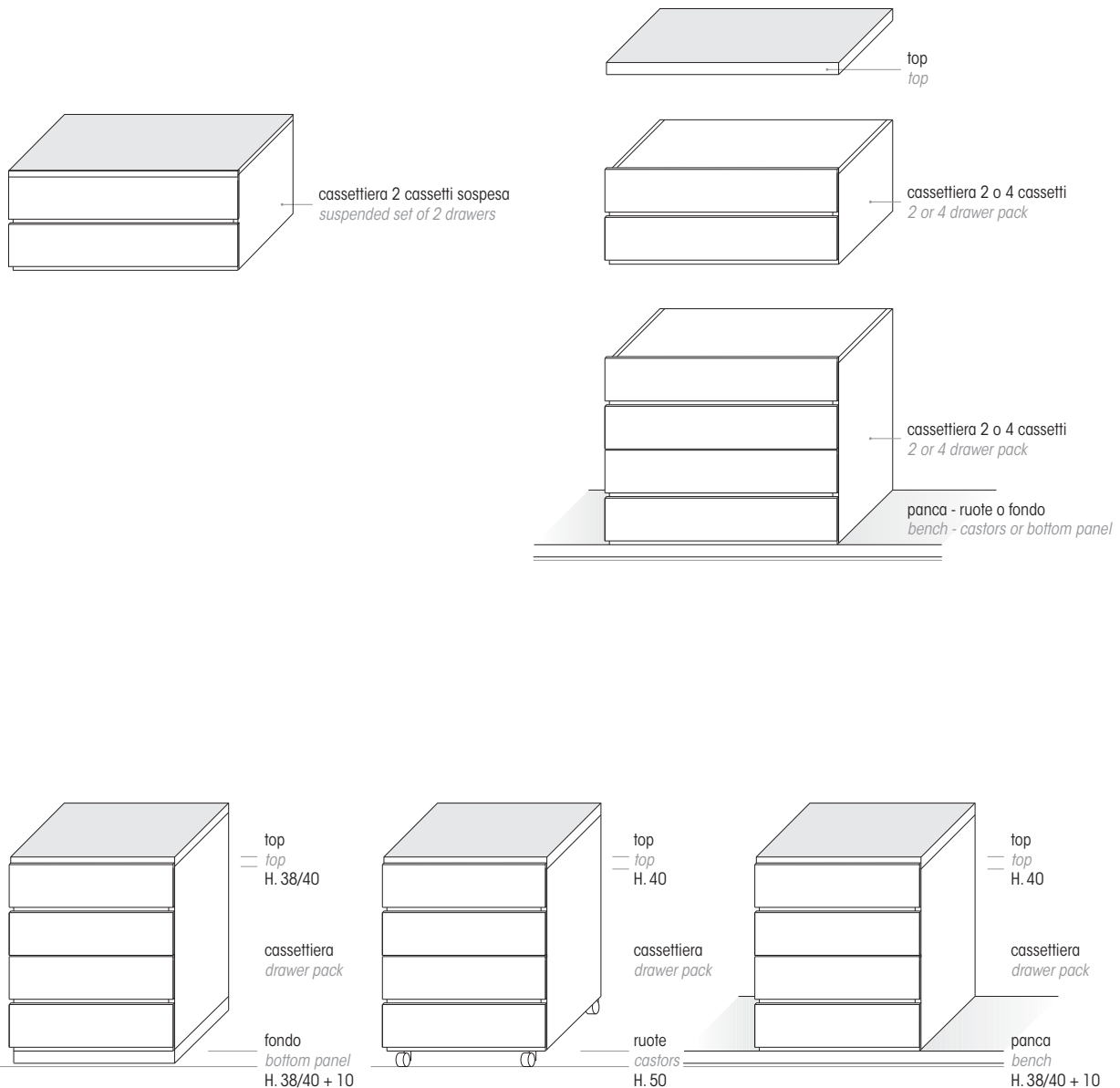

## Cassettiere 2 cassetti sospese - frontali legno

Suspended sets of 2 drawers - wooden fronts

H. 424 x P/D. 500

**NB: Le cassettiere sospese non sono tra loro sovrapponibili**

*NB: The wall-hung drawer packs cannot be mounted one on top of the other*

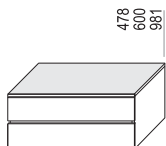

Larghezza Width	Codice Code	Melaminico cat. 1 Melamine cat. 1	Melaminico cat. 2 Melamine cat. 2	Laccato opaco Matt lacq.	Laccato lucido Glossy lacq.	VOL. m <sup>3</sup> P. GR. W. Kg
L. 478	PRC04544	<b>302</b>	<b>325</b>	<b>394</b>	<b>456</b>	0,131 m <sup>3</sup> 28 Kg
L. 600	PRC04564	<b>325</b>	<b>350</b>	<b>435</b>	<b>513</b>	0,163 m <sup>3</sup> 33 Kg
L. 981	PRC04594	<b>394</b>	<b>433</b>	<b>560</b>	<b>666</b>	0,261 m <sup>3</sup> 48 Kg

## Cassettiere 2 cassetti sospese - 1 frontale vetro + 1 frontale legno

Suspended sets of 2 drawers - 1 glass front + 1 wooden front

H. 424 x P/D. 500

**NB: Le cassettiere sospese non sono tra loro sovrapponibili**

*NB: The wall-hung drawer packs cannot be mounted one on top of the other*

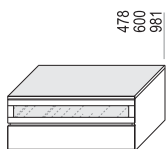

Larghezza Width	Codice Code	Melaminico cat. 1 Melamine cat. 1	Melaminico cat. 2 Melamine cat. 2	Laccato opaco Matt lacq.	Laccato lucido Glossy lacq.	VOL. m <sup>3</sup> P. GR. W. Kg
L. 478	PRC05544	<b>338</b>	<b>359</b>	<b>432</b>	<b>481</b>	0,131 m <sup>3</sup> 28 Kg
L. 600	PRC05564	<b>361</b>	<b>387</b>	<b>468</b>	<b>543</b>	0,163 m <sup>3</sup> 33 Kg
L. 981	PRC05594	<b>436</b>	<b>473</b>	<b>595</b>	<b>696</b>	0,261 m <sup>3</sup> 48 Kg

## Cassettiere 2 cassetti sospese - frontali vetro

Suspended sets of 2 drawers - glass fronts

H. 424 x P/D. 500

**NB: Le cassettiere sospese non sono tra loro sovrapponibili**

*NB: The wall-hung drawer packs cannot be mounted one on top of the other*

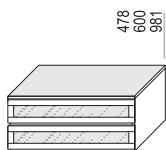

Larghezza Width	Codice Code	Melaminico cat. 1 Melamine cat. 1	Melaminico cat. 2 Melamine cat. 2	Laccato opaco Matt lacq.	Laccato lucido Glossy lacq.	VOL. m <sup>3</sup> P. GR. W. Kg
L. 478	PRC06544	<b>373</b>	<b>394</b>	<b>470</b>	<b>506</b>	0,131 m <sup>3</sup> 28 Kg
L. 600	PRC06564	<b>399</b>	<b>423</b>	<b>502</b>	<b>574</b>	0,163 m <sup>3</sup> 33 Kg
L. 981	PRC06594	<b>478</b>	<b>514</b>	<b>632</b>	<b>726</b>	0,261 m <sup>3</sup> 48 Kg

# PROJECT | EASY PROJECT - CASSETTIERE IN APPOGGIO | LEANING SETS OF DRAWERS

## Top per cassettiere in appoggio | Tops for standing drawer packs

Sp. | Th. 38/40 x P | D. 500

Aggiungere sempre il top sopra la cassettiere.

Always add the top on set of drawers.

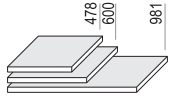

Larghezza Width	Codice Code	Melaminico cat. 1 Melamine cat. 1	Melaminico cat. 2 Melamine cat. 2	Laccato opaco Matt lacq.	Laccato lucido Glossy lacq.	VOL. m <sup>3</sup> P.   GR. W. Kg
L. 478	PRC40541	<b>40</b>	<b>44</b>	<b>58</b>	<b>79</b>	0,0155 m <sup>3</sup> 6,0 Kg
L. 600	PRC40561	<b>44</b>	<b>51</b>	<b>68</b>	<b>94</b>	0,0193 m <sup>3</sup> 7,6 Kg
L. 981	PRC40591	<b>63</b>	<b>72</b>	<b>100</b>	<b>142</b>	0,0312 m <sup>3</sup> 12,4 Kg

## 4 Ruote piroettanti | 4 swivelling wheels

H. 50

Non si possono sovrapporre cassettiere con più di 4 cassetti alle ruote.

Castors cannot be mounted on drawer packs with more than 4 drawers.

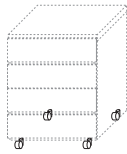

Codice Code	Finitura grigia Aluminium finish
PRXR1 355	<b>25</b>

## Fondi per cassettiere Sp. 38/40 con piedini regolabili H. 10

Bottoms for set of drawers Th. 38/40 with adjusting feet H. 10

P | D. 500

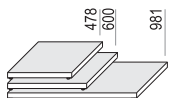

Larghezza Width	Codice Code	Melaminico cat. 1 Melamine cat. 1	Melaminico cat. 2 Melamine cat. 2	Laccato opaco Matt lacq.	Laccato lucido Glossy lacq.	VOL. m <sup>3</sup> P.   GR. W. Kg
L. 478	PRB40541	<b>40</b>	<b>44</b>	<b>58</b>	<b>79</b>	0,0155 m <sup>3</sup> 6,0 Kg
L. 600	PRB40561	<b>44</b>	<b>51</b>	<b>68</b>	<b>94</b>	0,0193 m <sup>3</sup> 7,6 Kg
L. 981	PRB40591	<b>63</b>	<b>72</b>	<b>100</b>	<b>142</b>	0,0312 m <sup>3</sup> 12,4 Kg

## Cassettiere 2 cassetti in appoggio - frontali legno

*Leaning sets of 2 drawers - wooden fronts*

**H. 384 x P|D. 500**

Aggiungere sempre il top alla cassettera.

*Always add a top to the drawer pack.*

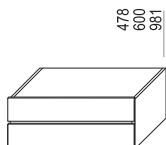

Larghezza Width	Codice Code	Melaminico cat. 1 Melamine cat. 1	Melaminico cat. 2 Melamine cat. 2	Laccato opaco Matt lacq.	Laccato lucido Glossy lacq.	VOL. m <sup>3</sup> P. GR. W. Kg
L. 478	PRC01543	<b>236</b>	<b>253</b>	<b>309</b>	<b>350</b>	0,115 m <sup>3</sup> 22 Kg
L. 600	PRC01563	<b>254</b>	<b>273</b>	<b>341</b>	<b>393</b>	0,163 m <sup>3</sup> 25 Kg
L. 981	PRC01593	<b>304</b>	<b>333</b>	<b>433</b>	<b>497</b>	0,230 m <sup>3</sup> 36 Kg

## Cassettiere 2 cassetti in appoggio - 1 frontale vetro + 1 frontale legno

*Leaning sets of 2 drawers - 1 glass front + 1 wooden front*

**H. 384 x P|D. 500**

Aggiungere sempre il top alla cassettera.

*Always add a top to the drawer pack.*

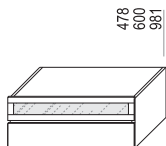

Larghezza Width	Codice Code	Melaminico cat. 1 Melamine cat. 1	Melaminico cat. 2 Melamine cat. 2	Laccato opaco Matt lacq.	Laccato lucido Glossy lacq.	VOL. m <sup>3</sup> P. GR. W. Kg
L. 478	PRC02543	<b>271</b>	<b>287</b>	<b>347</b>	<b>376</b>	0,115 m <sup>3</sup> 22 Kg
L. 600	PRC02563	<b>290</b>	<b>310</b>	<b>374</b>	<b>423</b>	0,163 m <sup>3</sup> 25 Kg
L. 981	PRC02593	<b>346</b>	<b>374</b>	<b>469</b>	<b>527</b>	0,230 m <sup>3</sup> 35 Kg

## Cassettiere 2 cassetti in appoggio - frontali vetro

*Leaning sets of 2 drawers - glass fronts*

**H. 384 x P|D. 500**

Aggiungere sempre il top alla cassettera.

*Always add a top to the drawer pack.*

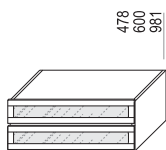

Larghezza Width	Codice Code	Melaminico cat. 1 Melamine cat. 1	Melaminico cat. 2 Melamine cat. 2	Laccato opaco Matt lacq.	Laccato lucido Glossy lacq.	VOL. m <sup>3</sup> P. GR. W. Kg
L. 478	PRC03543	<b>307</b>	<b>323</b>	<b>386</b>	<b>401</b>	0,115 m <sup>3</sup> 22 Kg
L. 600	PRC03563	<b>328</b>	<b>347</b>	<b>408</b>	<b>454</b>	0,163 m <sup>3</sup> 25 Kg
L. 981	PRC03593	<b>388</b>	<b>415</b>	<b>504</b>	<b>558</b>	0,230 m <sup>3</sup> 35 Kg

## Cassettiere 4 cassetti in appoggio - frontali legno

*Leaning sets of 4 drawers - wooden fronts*

**H. 768 x P|D. 500**

Aggiungere sempre il top alla cassetiera.

*Always add a top to the drawer pack.*

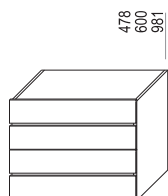

Larghezza Width	Codice Code	Melaminico cat. 1 Melamine cat. 1	Melaminico cat. 2 Melamine cat. 2	Laccato opaco Matt lacq.	Laccato lucido Glossy lacq.	VOL. m <sup>3</sup> P. GR. W. Kg
L. 478	PRC01547	<b>402</b>	<b>430</b>	<b>519</b>	<b>616</b>	0,223 m <sup>3</sup> 37 Kg
L. 600	PRC01567	<b>434</b>	<b>464</b>	<b>567</b>	<b>669</b>	0,276 m <sup>3</sup> 42 Kg
L. 981	PRC01597	<b>514</b>	<b>557</b>	<b>700</b>	<b>828</b>	0,443 m <sup>3</sup> 58 Kg

## Cassettiere 4 cassetti in appoggio - 2 frontali vetro + 2 frontali legno

*Leaning sets of 4 drawers - 2 glass fronts + 2 wooden fronts*

**H. 768 x P|D. 500**

Aggiungere sempre il top alla cassetiera.

*Always add a top to the drawer pack.*

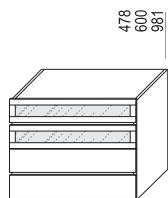

Larghezza Width	Codice Code	Melaminico cat. 1 Melamine cat. 1	Melaminico cat. 2 Melamine cat. 2	Laccato opaco Matt lacq.	Laccato lucido Glossy lacq.	VOL. m <sup>3</sup> P. GR. W. Kg
L. 478	PRC02547	<b>472</b>	<b>499</b>	<b>595</b>	<b>665</b>	0,223 m <sup>3</sup> 37 Kg
L. 600	PRC02567	<b>509</b>	<b>537</b>	<b>634</b>	<b>731</b>	0,276 m <sup>3</sup> 42 Kg
L. 981	PRC02597	<b>598</b>	<b>638</b>	<b>772</b>	<b>888</b>	0,443 m <sup>3</sup> 58 Kg

## Cassettiere 4 cassetti in appoggio - frontali vetro

*Leaning sets of 4 drawers - glass fronts*

**H. 768 x P|D. 500**

Aggiungere sempre il top alla cassetiera.

*Always add a top to the drawer pack.*

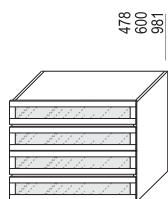

Larghezza Width	Codice Code	Melaminico cat. 1 Melamine cat. 1	Melaminico cat. 2 Melamine cat. 2	Laccato opaco Matt lacq.	Laccato lucido Glossy lacq.	VOL. m <sup>3</sup> P. GR. W. Kg
L. 478	PRC03547	<b>543</b>	<b>569</b>	<b>671</b>	<b>715</b>	0,223 m <sup>3</sup> 37 Kg
L. 600	PRC03567	<b>583</b>	<b>610</b>	<b>701</b>	<b>792</b>	0,276 m <sup>3</sup> 42 Kg
L. 981	PRC03597	<b>681</b>	<b>718</b>	<b>844</b>	<b>949</b>	0,443 m <sup>3</sup> 58 Kg

## Porta pantaloni estraibile | Pullout trousers-rack

Guide estrazione totale con chiusura ammortizzata | Soft-closing full-extension runners

H. 105 x P/D. 500

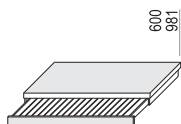

Larghezza Width	Codice Code	Melaminico cat. 1 Melamine cat. 1	Melaminico cat. 2 Melamine cat. 2	Laccato opaco Matt lacq.	Laccato lucido Glossy lacq.	VOL. m <sup>3</sup> P.   GR. W. Kg
L. 600	PRXT1561	<b>259</b>	<b>268</b>	<b>300</b>	<b>345</b>	0,0403 m <sup>3</sup> 11,6 Kg
L. 981	PRXT1591	<b>315</b>	<b>327</b>	<b>373</b>	<b>438</b>	0,0651 m <sup>3</sup> 17,8 Kg

## Porta cravatte-cinture estraibile | Pullout tie-rack or belt-rack

Guide estrazione totale con chiusura ammortizzata | Soft-closing full-extension runners

H. 105 x P/D. 500

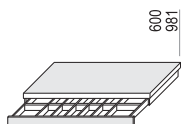

Larghezza Width	Codice Code	Melaminico cat. 1 Melamine cat. 1	Melaminico cat. 2 Melamine cat. 2	Laccato opaco Matt lacq.	Laccato lucido Glossy lacq.	VOL. m <sup>3</sup> P.   GR. W. Kg
L. 600	PRXT2561	<b>316</b>	<b>324</b>	<b>356</b>	<b>401</b>	0,0403 m <sup>3</sup> 14,5 Kg
L. 981	PRXT2591	<b>382</b>	<b>394</b>	<b>440</b>	<b>506</b>	0,0651 m <sup>3</sup> 22,8 Kg

## Vaschetta estraibile | Pullout tray

Guide estrazione totale con chiusura ammortizzata | Soft-closing full-extension runners

H. 105 x P/D. 500

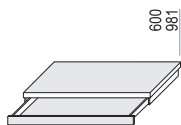

Larghezza Width	Codice Code	Melaminico cat. 1 Melamine cat. 1	Melaminico cat. 2 Melamine cat. 2	Laccato opaco Matt lacq.	Laccato lucido Glossy lacq.	VOL. m <sup>3</sup> P.   GR. W. Kg
L. 600	PRXT3561	<b>264</b>	<b>271</b>	<b>303</b>	<b>348</b>	0,0403 m <sup>3</sup> 13,6 Kg
L. 981	PRXT3591	<b>315</b>	<b>327</b>	<b>373</b>	<b>438</b>	0,0651 m <sup>3</sup> 21,0 Kg

## Staffa per servetto

### Pull-down rail bracket

Calcolare le quantità di staffe da ordinare (vedi esempio pag. 24)

Calculate the quantity of brackets to order (see example on page 24)



	<b>Codice</b> <i>Code</i>	Finitura Alluminio <i>Aluminium finish</i>				
	PRXS5132	<b>25</b>				

## Servetti | Clothes lifts

Il prezzo è comprensivo: servetto + 2 tasche

The price includes: 1 pull-down rail + 2 pockets

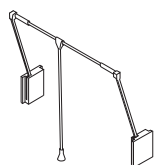

<b>Larghezza</b> <i>Width</i>	<b>Codice</b> <i>Code</i>	Finitura Alluminio <i>Aluminium finish</i>				VOL. m <sup>3</sup> P.   GR. W. Kg
L. 478	PRXSE002	<b>116</b>				0,0193 m <sup>3</sup> 3,3 Kg
L. 600	PRXSE002	<b>116</b>				0,0193 m <sup>3</sup> 3,3 Kg
L. 981	PRXSE004	<b>116</b>				0,0193 m <sup>3</sup> 3,6 Kg

## Tubi appendiabiti | Clothes hangers

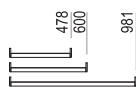

<b>Larghezza</b> <i>Width</i>	<b>Codice</b> <i>Code</i>	Finitura Alluminio <i>Aluminium finish</i>				
L. 478	EMXTT133	<b>12</b>				
L. 600	EMXTT143	<b>13</b>				
L. 981	EMXTT183	<b>16</b>				

## Appendigrucce girevole da fissare sotto il ripiano

### Swivel hanger to fix under the shelf

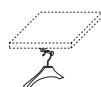

	<b>Codice</b> <i>Code</i>	Finitura Alluminio <i>Aluminium finish</i>				
	EMXAG002	<b>26</b>				

**Gruccia in legno | Wooden clothes hanger**



	<b>Codice Code</b>	Legno Wood					VOL. m <sup>3</sup> P. GR. W. Kg
	EMXGR002	<b>39</b>					0,0062 m <sup>3</sup> 0,4 Kg

**Asta appendiabiti | Stick for hangers**



	<b>Codice Code</b>	Alluminio e legno Aluminium-wood					
	EMXAA002	<b>27</b>					

**Scatole rivestite in tessuto | Boxes covered with fabric**  
H. 260 x P/D. 480

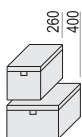

<b>Larghezza Width</b>	<b>Codice Code</b>	Tessuto Fabric					VOL. m <sup>3</sup> P. GR. W. Kg
L. 260	EMXSC002	<b>69</b>					0,0357 m <sup>3</sup> 1,8 Kg
L. 400	EMXSC004	<b>76</b>					0,0542 m <sup>3</sup> 2,2 Kg



**Lampada LED ad incasso, da completare con kit di connessione**

*Recessed LED light, to be completed by connecting kit*

Il sistema di accensione deve essere collegato ad un interruttore della rete elettrica della stanza  
*The switch-on system must be connected to a switch belonging to the electric system of the room*

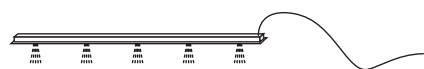

Larghezza Width	Codice Code	
L. 376	PRXLI223	<b>64</b>
L. 826	PRXLI243	<b>88</b>

**Kit di connessione per lampada LED + 1 prolunga - 1 kit supporta massimo 6 lampade L. 376 e 3 lampade L. 826**

*Connecting kit for LED light + 1 extension lead - 1 kit supports maximum 6 lights L. 376 and 3 lights L. 826*

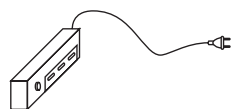

	Codice Code	
	EMXTL163	<b>34</b>

**Prezzo | Price**

<b>Riduzione pannelli boiserie in larghezza</b> <i>Width reduction of wall panels</i>	Maggiorazione <i>Surcharge</i>	<b>49</b>
<b>Riduzione pannelli boiserie in altezza</b> <i>Height reduction of wall panels</i>	Maggiorazione <i>Surcharge</i>	<b>49</b>
<b>Riduzione cremagliera in altezza</b> <i>Height reduction of rack</i>	Maggiorazione <i>Surcharge</i>	<b>49</b>
<b>Riduzione cornici terminali e terminale angolo in altezza</b> <i>Height reduction of end frames and end corner element</i>	Maggiorazione <i>Surcharge</i>	<b>49</b>
<b>Riduzione pannello di compensazione in larghezza</b> <i>Width reduction of filler panel</i>	Maggiorazione <i>Surcharge</i>	<b>49</b>
<b>Riduzione pannello di compensazione in altezza</b> <i>Height reduction of filler pane</i>	Maggiorazione <i>Surcharge</i>	<b>49</b>
<b>Riduzione ripiani in larghezza</b> <i>Width reduction of shelves</i>	Maggiorazione <i>Surcharge</i>	<b>37</b>
<b>Riduzione in larghezza porta scarpe sospeso</b> <i>Width reduction of wall-hung shoe-rack</i>	Maggiorazione <i>Surcharge</i>	<b>75</b>
<b>Riduzione ripiani in profondità più staffe</b> <i>Depth reduction of shelves with brackets</i>	Maggiorazione <i>Surcharge</i>	<b>86</b>
<b>Riduzione in profondità panche</b> <i>Depth reduction of benches</i>	Maggiorazione <i>Surcharge</i>	<b>49</b>
<b>Riduzione tubi appendiabiti in larghezza</b> <i>Width reduction of hanging rails</i>	Maggiorazione <i>Surcharge</i>	<b>22</b>
<b>Tagli inclinati</b> <i>Slanting reductions</i>	Maggiorazione <i>Surcharge</i>	<b>81</b>
<b>Laccato a campione (comunicare codice RAL di riferimento)</b> <i>Ral colour lacquers (please indicate the RAL colour code)</i>	Maggiorazione <i>Surcharge</i>	<b>+20%</b>

**Eventuali lavorazioni non previste nel presente listino dovranno essere preventivamente richieste ai nostri Uff. vendite.**  
*Any modification not indicated in this price list must be checked for feasibility with our Sales Department.*



**HOW TO FILL IN AN ORDER FORM**

Width of room

Width of walk-in closet

Height of the room

Height of the walk-in closet

**Project Wall panelling finishes**

a ric-e ect melamine

im melamine

Heat-treate a melamine

att lac uer

loss lac uer

lain mirror

mo e glass mirror

**ccessor inishes**

a ric-e ect melamine

im melamine

Heat-treate a melamine

att lac uer

loss lac uer

pa H W WH CH B C C C H H H C H C

CH

4 mm

0 4 0 4 0 4 0 4 0 4 0 4

CH

total 4 5 mm

the following information is required to fill in the order form

draw the front views of each wall indicating a reference or each e.g. - B on the top view specifying widths and heights.

specify the measurements of the room the wall - in the closet will be installed in.

indicate which type of wall - in the closet is required or as project without wall panelling.

specify drawing them or describing them

Benches Wall panels with mirror Hanging rails Pull-down rails Pull-out accessories see examples.



**DA**  
DALL'AGNESE

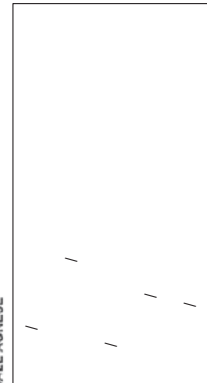

**Project Wall paneling finishes**

a rice-ect melamine

lin melamine

Heat-treate a melamine

att lac uer

loss lac uer

lain mirror

mo e glass mirror

**ccessor finishes**

a ric-e ect melamine

lin melamine

Heat-treate a melamine

att lac uer

loss lac uer

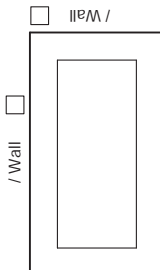

**Project Wall paneling finishes**

a ric-ect melamine

lin melamine

Heat-treate a melamine

att lac uer

loss lac uer

lain mirror

mo e glass mirror

**ccessor finishes**

a ric-e ect melamine

lin melamine

Heat-treate a melamine

att lac uer

loss lac uer

**Project Wall paneling finishes**

a ric-ect melamine

lin melamine

Heat-treate a melamine

att lac uer

loss lac uer

lain mirror

mo e glass mirror

**ccessor finishes**

a ric-e ect melamine

lin melamine

Heat-treate a melamine

att lac uer

loss lac uer

/ Wi th o room

/ Wi th o wal - in closet

**D'A**  
DALL'AGNESE

**ro ect Wall panelling inishes**

a rice ect melamine

Im melamine

Heat-treate a melamine

att lac uer

loss lac uer

lain mirror

mo e glass mirror

**ccessor inishes**

a rice ect melamine

Im melamine

Heat-treated ak melamine

Matt lac uer

lo lac uer

pa H H W WH CH B C C C C C H H W H H C H

La fornitura si intende ai prezzi indicati nel listino ed alle condizioni generali di vendita in vigore, che si intendono conosciute ed accettate dal Cliente. I prezzi indicati nel listino, espressi in euro, sono al netto di iva, installazione e/o qualsiasi prestazione ulteriore. Gli eventuali lavori "fuori misura", se non già regolamentati nel listino, qualora approvati dalla Dall'Agnese s.p.a. verranno quotati e valorizzati caso per caso.

Le proposte d'ordine si intendono accettate "salvo approvazione della casa", che la Dall'Agnese s.p.a. si riserva di dare a proprio esclusivo ed insindacabile giudizio.

I termini di consegna comunicati al Cliente non possono considerarsi vincolanti in quanto sono subordinati ai tempi di produzione e/o alla disponibilità della merce a magazzino. Qualora per causa di forza maggiore venga previsto un ritardo rispetto ai termini di consegna comunicati verrà concordato tra le parti un nuovo termine.

Viene escluso sin d'ora che i ritardi possano dare diritto a qualsiasi risarcimento danni, diretto o indiretto, o annullamento dell'ordine.

La merce viaggia a rischio e pericolo del Cliente quando venduta franco fabbrica.

In caso di consegna richiesta in un luogo diverso dal punto di vendita o magazzino dell'acquirente, sarà applicato un supplemento di prezzo, quantificato caso per caso. Resta inteso che la merce viene sempre consegnata "sponda camion".

Il Cliente è tenuto ad ispezionare accuratamente la merce ricevuta ed eventuali reclami riguardanti danni subiti durante il trasporto dovranno essere immediatamente segnalati al vettore ed annotati sul documento di trasporto; reclami riguardanti la qualità della merce e/o eventuali difetti di fabbricazione e/o difformità rispetto all'ordine dovranno pervenire entro e non oltre otto giorni dalla consegna alla Dall'Agnese s.p.a. a mezzo raccomandata a.r. Trascorso tale periodo la Dall'Agnese s.p.a. declina qualsiasi propria responsabilità. In relazione ai reclami rivolti nei modi e nei tempi sopra descritti si precisa, comunque, che non si accetteranno resi di merce se non debitamente autorizzati dalla Dall'Agnese s.p.a.

La merce, qualora sostituita, dovrà essere immediatamente resa disponibile correttamente imballata dal Cliente, all'atto della sostituzione stessa.

Qualora, per qualsiasi motivo, la merce sostituita non fosse resa disponibile la Dall'Agnese s.p.a. si riserva trascorsi 30 giorni dalla sostituzione, il diritto di esigerne il pagamento.

I resi accettati saranno valutati al prezzo pagato dal Cliente e, se non in buono stato di conservazione, al valore riconosciuto ad insindacabile giudizio dell'ufficio tecnico della Dall'Agnese s.p.a.

Si precisa che anche nel caso di reclami effettuati entro i termini i pagamenti non potranno essere sospesi.

Per le lavorazioni eseguite "fuori misura" e/o personalizzate su richiesta del Cliente non si accettano né resi né richieste di sostituzione. Le modalità di pagamento ed i relativi termini sono quelli concordati previamente con la Dall'Agnese s.p.a. e così come risultanti nella relativa "scheda anagrafica". Sono ritenuti validi solo i pagamenti effettuati direttamente alla Dall'Agnese s.p.a. e/o a propri incaricati e/o propri agenti autorizzati. I titoli di credito eventualmente accettati lo sono sempre "salvo buon fine". Il ritardo nei pagamenti, anche di una sola rata, dà diritto alla Dall'Agnese s.p.a. di richiedere l'integrale pagamento del prezzo di vendita con l'aggravio degli interessi legali ed eventuali spese. La merce rimane di proprietà della Dall'Agnese s.p.a. fino all'avvenuto integrale pagamento del prezzo di vendita.

Eventuali insolvenze o ritardi nei pagamenti in scadenza da parte del Cliente relativamente a forniture già effettuate, daranno facoltà alla Dall'Agnese s.p.a. di sospendere o annullare l'esecuzione degli ordini in corso anche se già accettati.

In riferimento al continuo miglioramento tecnologico del prodotto la Dall'Agnese s.p.a. si riserva il diritto di apportare le modifiche ritenute più opportune alla modellistica, che non abbiano ad incidere negativamente sulla qualità e sull'estetica del prodotto stesso e ciò a proprio insindacabile giudizio e senza la necessità di un preavviso.

I colori delle parti verniciate e delle essenze sono indicativi in quanto non è tecnicamente possibile mantenere le stesse tonalità di colore nel tempo; si declina, pertanto, ogni responsabilità per richieste di accoppiamento pervenute in tempi diversi anche se la Dall'Agnese s.p.a. si adopererà a fornire la migliore soluzione tecnica possibile.

È facoltà della Dall'Agnese s.p.a. di apportare, a proprio insindacabile giudizio, in qualsiasi momento e senza preavviso, tutte le variazioni che riterrà necessarie, alle caratteristiche tecniche, costruttive, estetiche dei propri modelli, nonché ai prezzi indicati nel presente listino.

I cataloghi e i dépliant in circolazione hanno valore puramente illustrativo, eventuali inesattezze di stampa e/o di descrizione delle caratteristiche e/o indicazioni di misure non sostanziali dei prodotti non potranno dar luogo a responsabilità in capo alla Dall'Agnese s.p.a.

La Dall'Agnese s.p.a. garantisce i propri prodotti da difetti occulti e per l'utilizzo cui il bene è destinato; i danni derivanti da incuria, negligenza e/o uso improprio non daranno diritto a reclami e/o richieste di danni, diretti o indiretti.

Qualsiasi controversia che non fosse possibile risolvere in via bonaria tra le parti sarà devoluta all'unico Foro competente di Pordenone.

*The supply is understood to be at the prices specified in the price list and under the general conditions of sale in force, which the Customer is understood to have read and accepted. The prices specified in the price list, expressed in euros, are net of VAT, installation and/or any additional service.*

*Any custom work which is not already regulated in the price list, if approved by Dall'Agnese s.p.a., will be quoted and priced on an individual basis.*

*The orders are understood to be accepted "upon company approval", which Dall'Agnese s.p.a. reserves the right to give at its sole and final discretion.*

*The delivery dates notified to the Customer shall not be considered as binding since they are subject to the production times and/or availability of the goods in the warehouse.*

*If, due to force majeure, a delay is expected with respect to the notified delivery date, a new delivery date will be agreed upon between the parties.*

*It is hereby specified that any such delay shall not entitle the Customer to any damages, direct or consequential, or the cancellation of the order.*

*The goods travel at the risk and peril of the Customer when sold ex factory.*

*If delivery is requested to a location other than the buyer's point of sale or warehouse, a price supplement quantified on an individual basis will be applied.*

*It is understood that the goods are always delivered with "tailgate delivery".*

*The Customer is obligated to thoroughly inspect the goods received, and any claims concerning damages incurred during transport will have to be reported immediately to the carrier and noted on the shipping document; claims concerning the quality of the goods and/or any manufacturing defects and/or discrepancies with respect to the order will have to arrive to Dall'Agnese s.p.a. within and no later than eight days after the delivery by means of registered letter with return receipt. Once this period has lapsed, Dall'Agnese s.p.a. accepts no liability whatsoever. In relation to the claims made with the methods and within the times described above, however, it is specified that the returns of goods will not be accepted unless duly authorized by Dall'Agnese s.p.a.*

*The goods, in the event they are replaced, will have to be made available immediately, packaged correctly by the Customer, on replacement of the same.*

*In the event, for any reason, the replaced goods are not made available, Dall'Agnese s.p.a. reserves the right to demand payment 30 days after the replacement.*

*The accepted returns will be valued at the price paid by the Customer or, if not in a good state of preservation, at the value recognized at the final discretion of the Dall'Agnese s.p.a. engineering office.*

*It is specified that, even in the case of claims made within the terms, the payments cannot be suspended.*

*For any "outsized" machining and/or customizations executed on Customer request, neither returns nor requests for replacement will be accepted.*

*The methods of payment and relative terms are those agreed upon beforehand with Dall'Agnese s.p.a. and as reported in the respective "personal information file".*

*Only the payments made directly to Dall'Agnese s.p.a. and/or its representatives and/or its authorized agents are considered valid. Any credit instruments accepted are always accepted "subject to final payment". A delay in the payments, even of only a single instalment, gives Dall'Agnese s.p.a. the right to demand full payment of the sale price with an increase due to legal interest and any expenses. The goods remain the property of Dall'Agnese s.p.a. until receipt of the entire payment of the sales price.*

*Any insolvency or delays in the payments due from the Customer regarding supplies already executed will give Dall'Agnese s.p.a. the faculty to suspend or cancel execution of the orders in progress, even if already accepted. With reference to the continuous technological improvement of the product, Dall'Agnese s.p.a. reserves the right to make any modifications it considers appropriate to the modelling, which have no negative impact on the quality or aesthetics of the product itself, at its sole and final discretion without the need for any prior notice.*

*The colours of the painted parts and wood finishes are representative only, since it is not technically possible to maintain the same shades of colour over time; therefore Dall'Agnese s.p.a. accepts no liability for matching requests received at different times even though Dall'Agnese s.p.a. will work to provide the best technical solution possible. Dall'Agnese s.p.a. has the faculty to make, at its sole and final discretion and at any time without prior notice, all the variations it may consider necessary to the technical, constructional and/or aesthetic characteristics of its models, as well as the prices specified in this price list.*

*The catalogues and brochures in circulation are representative only; any unsubstantial inaccuracies in the printing and/or description of the characteristics and/or measurement specifications of the products shall not give rise to liability on the part of Dall'Agnese s.p.a.*

*Dall'Agnese s.p.a. guarantees its products against hidden defects and for the use for which they have been designed; any damage resulting from neglect, negligence and/or improper use shall not entitle the customer to make complaints and/or claims for direct or consequential damages.*

*Any dispute which cannot be resolved amicably between the parties shall be devolved to the exclusive jurisdiction of Pordenone.*