

# macramè

DESIGN  
LUCIDI & PEVERE

modello registrato  
registered model

portata sul piano: 40 kg  
load capacity on top: 40 kg

Collezione di tavolini composti da una base in vetro filato intrecciato in maniera artigianale e da un piano di vetro da 10 mm. La collezione di tavolini prevede le seguenti finiture: piano in vetro extralight con base in vetro extralight, piano in vetro bronzo con base verniciata bronzo, piano in vetro fumè con base verniciata fumè.

Collection of coffee tables comprising hand-interwoven spun glass base and 10 mm-thick glass top. The coffee table collection includes the following finishes: extralight glass top with extralight glass base; bronze glass top with bronze painted base; fumè grey glass top with fumè grey painted base.

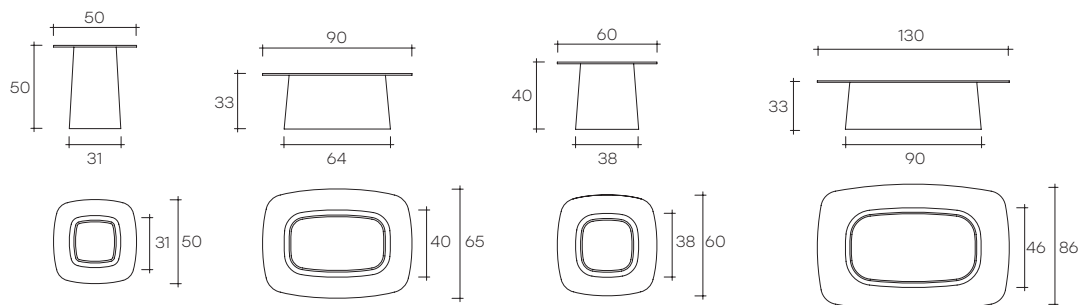

dimensioni L, P, H  
dimensions L, W, H  
(cm)

	COD./CODE	L	P/W	H	peso netto net weight (kg)	peso lordo gross weight (kg)	volume imballo package volume (m <sup>3</sup> )
Tavolino con piano e base in vetro extralight. Extralight top with extralight glass base.	<b>MC/130X</b>	130	86	33	52	77	0,64
	<b>MC/90X</b>	90	65	33	28	35	0,40
	<b>MC/60X</b>	60	60	40	21	28	0,31
	<b>MC/50X</b>	50	50	50	19	25	0,27
Tavolino con piano in bronzo e base verniciata bronzo. Bronze top with bronze painted base.	<b>MC/130BR</b>	130	86	33	52	77	0,64
	<b>MC/90BR</b>	90	65	33	28	35	0,40
	<b>MC/60BR</b>	60	60	40	21	28	0,31
	<b>MC/50BR</b>	50	50	50	19	25	0,27
Tavolino con piano in vetro fumè e base verniciata fumè. Coffee table with fumè grey glass top and fumè grey painted base.	<b>MC130/FU</b>	130	86	33	52	77	0,64
	<b>MC90/FU</b>	90	65	33	28	35	0,40
	<b>MC60/FU</b>	60	60	40	21	28	0,31
	<b>MC50/FU</b>	50	50	50	19	25	0,27