

# inori

DESIGN  
SETSU E SHINOBU ITO

modello registrato  
registered model

portata sui ripiani: 80 kg  
portata massima struttura: 400 kg  
distanza massima tra i montanti: 130 cm  
load capacity on shelves: 80 kg  
structure load capacity: 400 kg  
max. distance between the uprights: 130 cm

## Basi \_ Bases

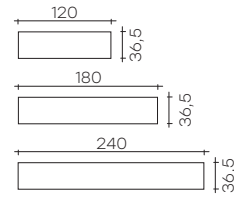

## Ripiani \_ Shelves

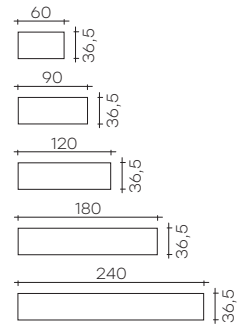

## Montanti \_ Uprights



Sistema composto da elementi in vetro o legno modulari. La modularità e versatilità ne permette l'utilizzo come libreria, espositore, contenitore porta tv, sviluppabili sia in situazioni con fissaggio a muro che autoportanti. Tutti i montanti sono liberamente posizionabili tramite sistema di ancoraggio e scorrimento a binario applicato su ogni singolo ripiano. Binario in alluminio anodizzato nero.

*Modular book shelves glass or wood system. The versatility and assembly possibilities allow the utilization as a show-case, display-case, TV-unit. Available the free-standing version and wall unit. The uprights are freely adjustable on each shelf through sliding rails and fixing device. Slides in anodized black aluminum.*

## COMPOSIZIONI / COMPOSITIONS

### COMP. A COMP. A

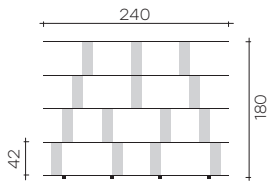

### COMP. A bis COMP. A bis

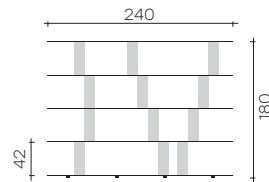

### COMP. B COMP. B

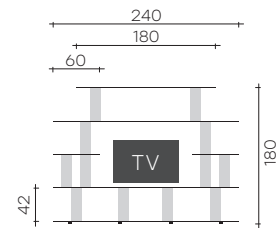

### COMP. C COMP. C

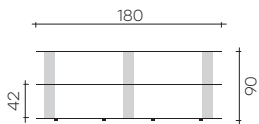

### COMP. D COMP. D

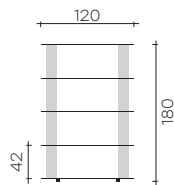

### COMP. E COMP. E

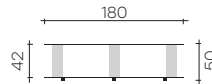

### COMP. F COMP. F

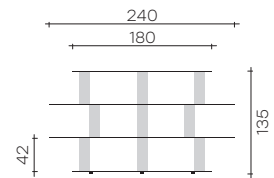

In tutte le composizioni sopra presentate i montanti hanno altezza H. 42 cm.  
In all the compositions presented above, the uprights are 42 cm high.



| dimensioni L, P, H<br><i>dimensions L, W, H</i><br>(cm)  | COD./CODE       | L   | P/W  | H   | peso netto<br><i>net weight</i><br>(kg) | peso lordo<br><i>gross weight</i><br>(kg) | volume imballo<br><i>package volume</i><br>(m <sup>3</sup> ) |
|--|-----------------|-----|------|-----|---|---|--|
| <b>COMPOSIZIONE A</b><br><b>COMPOSITION A</b>  |                 |     |      |     |   |   |  |
| base: fumé retro verniciata nera<br>4 ripiani: fumé<br>14 montanti: extralight<br><i>base: smoked glass black back-painted</i><br><i>4 shelves: smoked glass</i><br><i>14 uprights: extralight</i>               | <b>8401</b>     | 240 | 36,5 | 180 | 195                                     | 218                                       | 0,42   |
| <b>COMPOSIZIONE A bis</b><br><b>COMPOSITION A bis</b>  |                 |     |      |     |   |   |  |
| base: fumé retro verniciata nera<br>4 ripiani: trasparenti<br>12 montanti: trasparenti<br><i>base: smoked glass black back-painted</i><br><i>4 shelves: transparent</i><br><i>12 uprights: transparent</i>       | <b>8401/bis</b> | 240 | 36,5 | 180 | 186                                     | 214                                       | 0,36   |
| <b>COMPOSIZIONE B</b><br><b>COMPOSITION B</b>  |                 |     |      |     |   |   |  |
| base: extralight retro verniciata bianca<br>5 ripiani: trasparenti<br>12 montanti: trasparenti<br><i>base: extralight white back-painted</i><br><i>5 shelves: transparent</i><br><i>12 uprights: transparent</i> | <b>8402</b>     | 240 | 36,5 | 180 | 168                                     | 180                                       | 0,34   |
| <b>COMPOSIZIONE C</b><br><b>COMPOSITION C</b>  |                 |     |      |     |   |   |  |
| base: fumé retro verniciata nera<br>2 ripiani: fumé<br>6 montanti: nero95<br><i>base: smoked glass black back-painted</i><br><i>2 shelves: smoked glass</i><br><i>6 uprights: black95</i>                        | <b>8403</b>     | 180 | 36,5 | 90  | 89                                      | 100                                       | 0,18   |
| <b>COMPOSIZIONE D</b><br><b>COMPOSITION D</b>  |                 |     |      |     |   |   |  |
| base: extralight retro-argentata<br>4 ripiani: trasparenti<br>8 montanti: trasparenti<br><i>base: extralight back-silvered</i><br><i>4 shelves: transparent</i><br><i>8 uprights: transparent</i>                | <b>8404</b>     | 120 | 36,5 | 180 | 108                                     | 126                                       | 0,25   |
| <b>COMPOSIZIONE E</b><br><b>COMPOSITION E</b>  |                 |     |      |     |   |   |  |
| base: fumé retro verniciata nera<br>1 ripiani: extralight<br>3 montanti: nero95<br><i>base: smoked glass black back-painted</i><br><i>1 shelves: extralight</i><br><i>3 uprights: black95</i>                    | <b>8405</b>     | 180 | 36,5 | 50  | 55                                      | 62  | 0,12   |
| <b>COMPOSIZIONE F</b><br><b>COMPOSITION F</b>  |                 |     |      |     |   |   |  |
| base: fumé retro verniciata nera<br>3 ripiani: fumé<br>9 montanti: trasparenti<br><i>base: smoked glass black back-painted</i><br><i>3 shelves: smoked glass</i><br><i>9 uprights: transparent</i>               | <b>8406</b>     | 240 | 36,5 | 135 | 132                                     | 149                                       | 0,26   |

**Le composizioni sono intese ad agevolare la vendita proponendo una soluzione ed un prezzo predefiniti.  
Per altre e diverse composizioni e finiture riferirsi esclusivamente al listino dei singoli componenti.**

**All configurations are meant to help and promote sales by proposing a set solution and price.  
For all other possible configurations and finishings please refer to listed single components.**

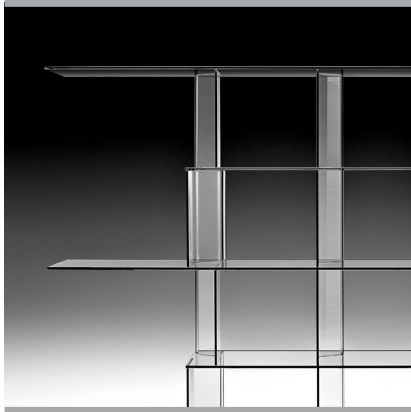

# inori

DESIGN  
SETSU E SHINOBU ITO

modello registrato  
registered model

portata sui ripiani: 80 kg  
portata massima struttura: 400 kg  
distanza massima tra i montanti: 130 cm  
load capacity on shelves: 80 kg  
structure load capacity: 400 kg  
max. distance between the uprights: 130 cm

## Basi \_ Bases

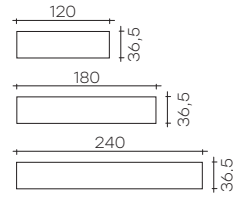

## Ripiani \_ Shelves

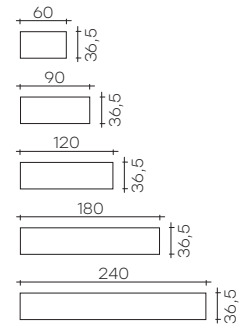

## Montanti \_ Uprights



ALCUNI SUGGERIMENTI TRA LE INFINITE SOLUZIONI / JUST A FEW OF THE NUMEROUS SOLUTIONS  
RIPIANI IN VETRO, SPESSORE 12 MM / GLASS SHELVES, 12 MM-THICK

### LIBRERIA BOOKCASE

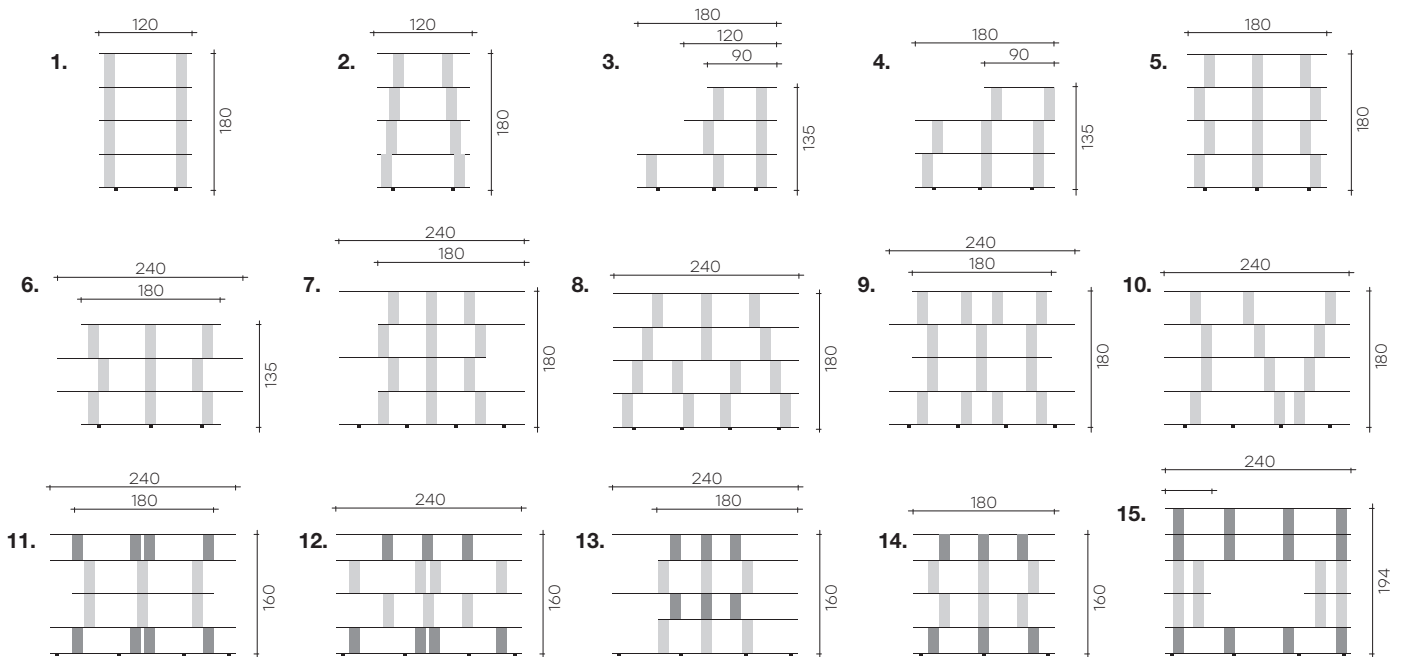

### PORTA TV TV UNIT

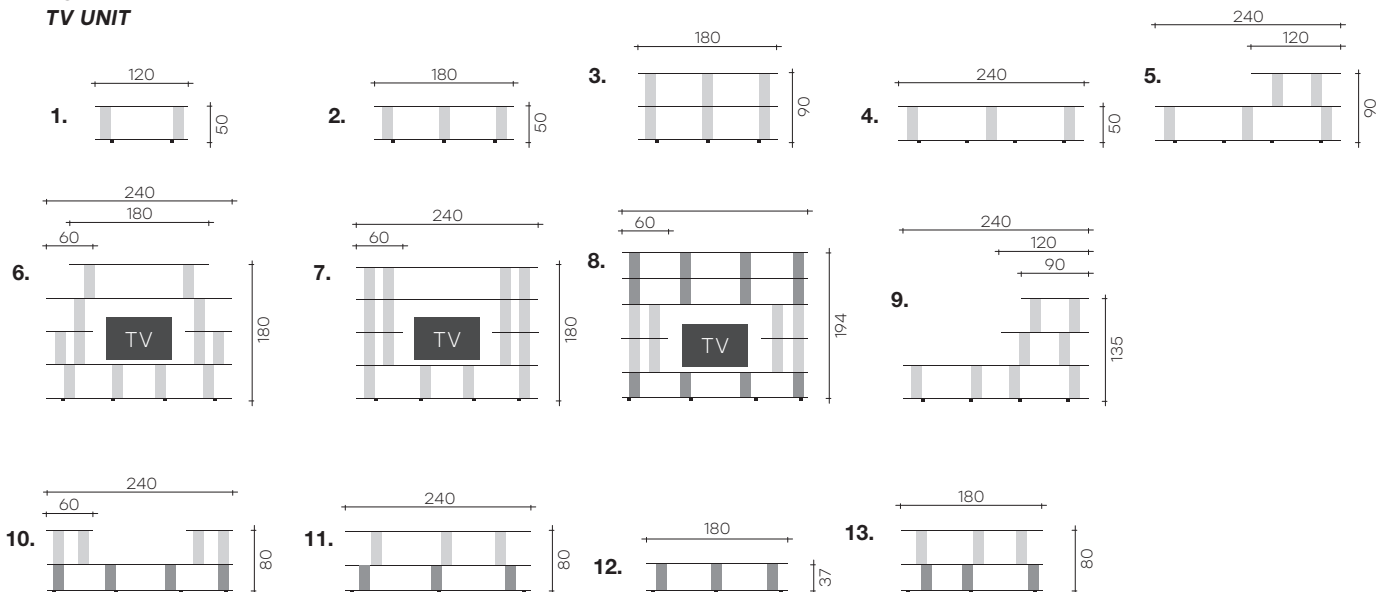



## CONSOLE CONSOLE

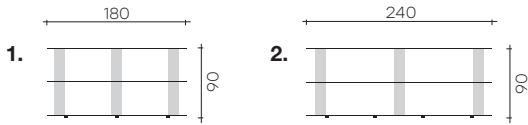

## RETRO DIVANO SOFA BACK SIDEBORD

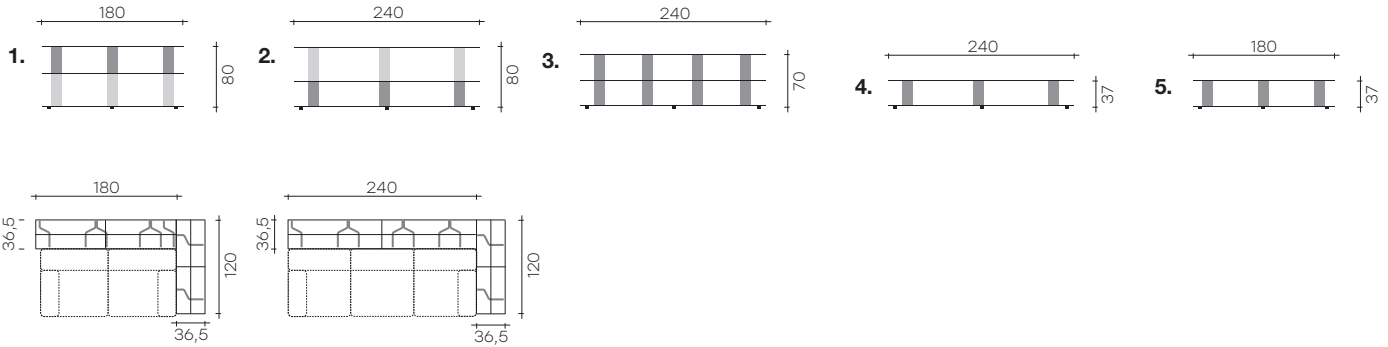

## MOBILE BASSO LOW UNIT

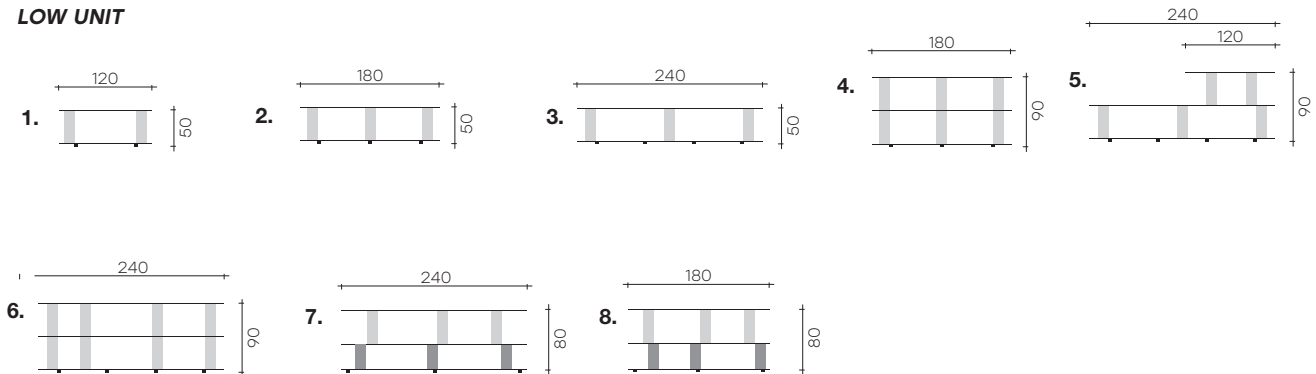

## SOLUZIONE CENTROSTANZA ROOM CENTREPIECE SOLUTION

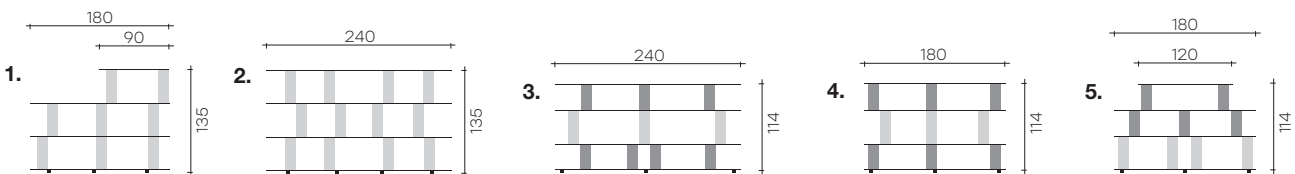

Altezza massima per le strutture autoportanti  
 Su basi di lunghezza 120 cm: h max 48 cm (vetro) o 51 cm (legno)  
 Su basi di lunghezza 180 cm: h max 135 cm (vetro) o 143 cm (legno)  
 Su basi di lunghezza 240 cm: h 178 cm (vetro) o 189 cm (legno)  
 con accessorio dedicato  
 Altezza massima per le strutture con ancoraggio a muro:  
 massimo 5 ripiani totali, base esclusa.

Max. height of the free-standing version  
 With base length 120 cm: h max 48 cm (glass) or 51 cm (wood)  
 With base length 180 cm: h max 135 cm (glass) or 143 cm (wood)  
 With base length 240 cm: h max 178 (glass) or 189 cm (wood)  
 with accessories  
 Max. height of the wall version:  
 max 5 shelves, base excluded.



# inori

DESIGN  
SETSU E SHINOBU ITO

modello registrato  
registered model

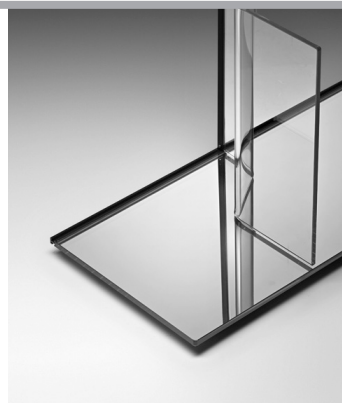
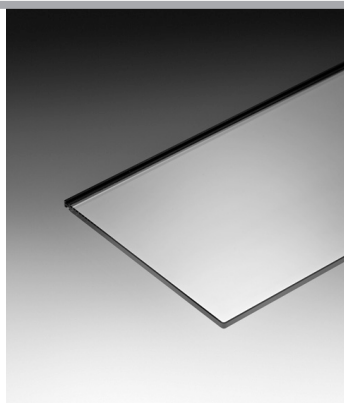

Ripiani in vetro temperato,  
spessore 12 mm  
o legno spessore 40 mm.  
*Shelves in tempered glass,  
12 mm-thick  
or wood 40 mm-thick.*

Base d'appoggio in vetro  
temperato, spessore 12 mm  
o legno spessore 40 mm.  
*Base in tempered glass,  
12 mm-thick  
or wood 40 mm-thick.*

Montanti in vetro curvato  
da 10 mm.  
*Uprights in curved glass,  
10 mm-thick.*

portata sui ripiani: 80 kg  
portata massima  
struttura: 400 kg  
distanza massima  
tra i montanti: 130 cm  
*load capacity on shelves: 80 kg  
structure load capacity: 400 kg  
max. distance between  
the uprights: 130 cm*

Altezza massima  
per le strutture autoportanti  
Su basi di lunghezza 120 cm:  
h max 50 cm  
Su basi di lunghezza 180 cm:  
h max 135 cm  
Su basi di lunghezza 240 cm  
solo vetro: h 180 cm,  
con accessorio dedicato  
Altezza massima per le strutture  
con ancoraggio a muro: massimo  
5 ripiani totali, base esclusa

*Max. height  
of the free-standing version  
With base length 120 cm:  
h max 50 cm  
With base length 180 cm:  
h max 135 cm  
With base length 240 cm  
glass version: h 180 cm,  
with accessories  
Max. height of the wall version:  
max 5 shelves, base excluded*

dimensioni L, P, H  
dimensions L, W, H  
(cm)

COD./CODE

L

P/W

H

peso netto  
net weight  
(kg)peso lordo  
gross weight  
(kg)volume imballo  
package volume  
(m<sup>3</sup>)

## BASI BASES

|  |                 |     |      |   |    |    |      |
|--|-----------------|-----|------|---|----|----|------|
| Fumé retro verniciato nero.<br><i>Smoked glass black back-painted.</i>       | <b>12036/N</b>  | 120 | 36,5 | 5 | 16 | 18 | 0,04 |
| Extralight retro verniciato bianco.<br><i>Extralight white back-painted.</i> | <b>12036/B</b>  | 120 | 36,5 | 5 | 16 | 18 | 0,04 |
| Extralight retro argentato.<br><i>Extralight back-silvered.</i>              | <b>12036/S</b>  | 120 | 36,5 | 5 | 16 | 18 | 0,04 |
| Fumé retro verniciato nero.<br><i>Smoked glass black back-painted.</i>       | <b>18036/N</b>  | 180 | 36,5 | 5 | 22 | 24 | 0,06 |
| Extralight retro verniciato bianco.<br><i>Extralight white back-painted.</i> | <b>18036/B</b>  | 180 | 36,5 | 5 | 22 | 24 | 0,06 |
| Extralight retro argentato.<br><i>Extralight back-silvered.</i>              | <b>18036/S</b>  | 180 | 36,5 | 5 | 22 | 24 | 0,06 |
| Ebano laccato lucido.<br><i>Glossy lacquered ebony.</i>                      | <b>18036/LE</b> | 180 | 37,5 | 5 | 16 | 18 | 0,06 |
| Rovere "Old".<br><i>"Old Style" oak.</i>                                     | <b>18036/RO</b> | 180 | 37,5 | 5 | 16 | 18 | 0,06 |
| Fumé retro verniciato nero.<br><i>Smoked glass black back-painted.</i>       | <b>24036/N</b>  | 240 | 36,5 | 5 | 28 | 30 | 0,08 |
| Extralight retro verniciato bianco.<br><i>Extralight white back-painted.</i> | <b>24036/B</b>  | 240 | 36,5 | 5 | 28 | 30 | 0,08 |
| Extralight retro argentato.<br><i>Extralight back-silvered.</i>              | <b>24036/S</b>  | 240 | 36,5 | 5 | 28 | 30 | 0,08 |
| Ebano laccato lucido.<br><i>Glossy lacquered ebony.</i>                      | <b>24036/LE</b> | 240 | 37,5 | 5 | 21 | 23 | 0,09 |
| Rovere "Old".<br><i>"Old Style" oak.</i>                                     | <b>24036/RO</b> | 240 | 37,5 | 5 | 21 | 23 | 0,09 |



| dimensioni L, P, H<br><i>dimensions L, W, H</i><br>(cm)       | COD./CODE       | L   | P/W  | H   | peso netto<br><i>net weight</i><br>(kg) | peso lordo<br><i>gross weight</i><br>(kg) | volume imballo<br><i>package volume</i><br>(m <sup>3</sup> ) |
|---|-----------------|-----|------|-----|---|---|--|
| <b>RIPIANI<br/>SHELVES</b>                                    |                 |     |      |     |   |   |  |
| Trasparente.<br><i>Transparent.</i>                           | <b>6036</b>     | 60  | 36,5 | 1,2 | 7                                       | 8   | 0,01   |
| Fumé.<br><i>Smoked glass.</i>                                 | <b>6036/F</b>   | 60  | 36,5 | 1,2 | 7                                       | 8   | 0,01   |
| Extralight.<br><i>Extralight.</i>                             | <b>6036/X</b>   | 60  | 36,5 | 1,2 | 7                                       | 8   | 0,01   |
| Trasparente.<br><i>Transparent.</i>                           | <b>9036</b>     | 90  | 36,5 | 1,2 | 10                                      | 11  | 0,01   |
| Fumé.<br><i>Smoked glass.</i>                                 | <b>9036/F</b>   | 90  | 36,5 | 1,2 | 10                                      | 11  | 0,01   |
| Extralight.<br><i>Extralight.</i>                             | <b>9036/X</b>   | 90  | 36,5 | 1,2 | 10                                      | 11  | 0,01   |
| Trasparente.<br><i>Transparent.</i>                           | <b>1236</b>     | 120 | 36,5 | 1,2 | 14                                      | 16  | 0,02   |
| Fumé.<br><i>Smoked glass.</i>                                 | <b>1236/F</b>   | 120 | 36,5 | 1,2 | 14                                      | 16  | 0,02   |
| Extralight.<br><i>Extralight.</i>                             | <b>1236/X</b>   | 120 | 36,5 | 1,2 | 14                                      | 16  | 0,02   |
| Trasparente.<br><i>Transparent.</i>                           | <b>1836</b>     | 180 | 36,5 | 1,2 | 20                                      | 22  | 0,03   |
| Fumé.<br><i>Smoked glass.</i>                                 | <b>1836/F</b>   | 180 | 36,5 | 1,2 | 20                                      | 22  | 0,03   |
| Extralight.<br><i>Extralight.</i>                             | <b>1836/X</b>   | 180 | 36,5 | 1,2 | 20                                      | 22  | 0,03   |
| Ebano laccato lucido.<br><i>Glossy lacquered ebony.</i>       | <b>1836/LE</b>  | 180 | 37,5 | 4   | 16                                      | 18  | 0,06   |
| Rovere "Old".<br><i>"Old Style" oak.</i>                      | <b>1836/RO</b>  | 180 | 37,5 | 4   | 16                                      | 18  | 0,06   |
| Trasparente.<br><i>Transparent.</i>                           | <b>2436</b>     | 240 | 36,5 | 1,2 | 26                                      | 28  | 0,04   |
| Fumé.<br><i>Smoked glass.</i>                                 | <b>2436/F</b>   | 240 | 36,5 | 1,2 | 26                                      | 28  | 0,04   |
| Extralight.<br><i>Extralight.</i>                             | <b>2436/X</b>   | 240 | 36,5 | 1,2 | 26                                      | 28  | 0,04   |
| Ebano laccato lucido.<br><i>Glossy lacquered ebony.</i>       | <b>2436/LE</b>  | 240 | 37,5 | 4   | 21                                      | 23  | 0,08   |
| Rovere "Old".<br><i>"Old Style" oak.</i>                      | <b>2436/RO</b>  | 240 | 37,5 | 4   | 21                                      | 23  | 0,08   |
| <b>PIANO SUPERIORE (senza fresata) / TOP (without groove)</b> |                 |     |      |     |   |   |  |
| Ebano laccato lucido.<br><i>Glossy lacquered ebony.</i>       | <b>1836/TLE</b> | 180 | 37,5 | 4   | 16                                      | 18  | 0,06   |
| Rovere "Old".<br><i>"Old Style" oak.</i>                      | <b>1836/TRO</b> | 180 | 37,5 | 4   | 16                                      | 18  | 0,06   |
| Ebano laccato lucido.<br><i>Glossy lacquered ebony.</i>       | <b>2436/TLE</b> | 240 | 37,5 | 4   | 21                                      | 23  | 0,08   |
| Rovere "Old".<br><i>"Old Style" oak.</i>                      | <b>2436/TRO</b> | 240 | 37,5 | 4   | 21                                      | 23  | 0,08   |

**FINITURA BASE E RIPIANI RETROLACCATI  
BACK-LACQUERED BASE AND SHELVES FINISH**

**SPESSORE  
THICKNESS**

|   |       |
|---|-------|
| Vetro extralight retrolaccato (laccato lucido)<br><i>Extralight back-lacquered glass (shiny lacquering)</i>                     | 12 mm |
| Vetro extralight acidato<br><i>Extralight acid-etched glass</i>   | 12 mm |
| Vetro extralight acidato (laccato opaco)<br><i>Extralight acid-etched glass (opaque lacquering)</i>                             | 12 mm |
| Vetro extralight acidato retrolaccato (laccato opaco)<br><i>Extralight acid-etched back-lacquered glass (opaque lacquering)</i> | 12 mm |



| dimensioni L, P, H<br><i>dimensions L, W, H</i><br>(cm) | COD./CODE            | L | P/W | H  | peso netto<br><i>net weight</i><br>(kg) | peso lordo<br><i>gross weight</i><br>(kg) | volume imballo<br><i>package volume</i><br>(m <sup>3</sup> ) |
|---|----------------------|---|-----|----|---|---|--|
| <b>MONTANTI</b><br><b>UPRIGHTS</b>                      |                      |   |     |    |   |   |  |
| Trasparente.<br><i>Transparent.</i>                     | <b>3532</b>          |   | 35  | 32 | 4,5                                     | 6   | 0,03   |
| Nero95.<br><i>Black95.</i>                              | <b>3532/<br/>N95</b> |   | 35  | 32 | 4,5                                     | 6   | 0,03   |
| Extralight.<br><i>Extralight.</i>                       | <b>3532/X</b>        |   | 35  | 32 | 4,5                                     | 6   | 0,03   |
| Bronzo.<br><i>Bronze.</i>                               | <b>3532/BR</b>       |   | 35  | 32 | 4,5                                     | 6   | 0,03   |
| Fumè.<br><i>Smoked.</i>                                 | <b>3532/FU</b>       |   | 35  | 32 | 4,5                                     | 6   | 0,03   |
| Trasparente.<br><i>Transparent.</i>                     | <b>3542</b>          |   | 35  | 42 | 4,5                                     | 6   | 0,03   |
| Nero95.<br><i>Black95.</i>                              | <b>3542/<br/>N95</b> |   | 35  | 42 | 4,5                                     | 6   | 0,03   |
| Extralight.<br><i>Extralight.</i>                       | <b>3542/X</b>        |   | 35  | 42 | 4,5                                     | 6   | 0,03   |
| Bronzo.<br><i>Bronze.</i>                               | <b>3542/BR</b>       |   | 35  | 42 | 4,5                                     | 6   | 0,03   |
| Fumè.<br><i>Smoked.</i>                                 | <b>3542/FU</b>       |   | 35  | 42 | 4,5                                     | 6   | 0,03   |

### Accessori/Accessories

| dimensioni L, P, H<br><i>dimensions L, W, H</i><br>(cm)   | COD./CODE   | L | P/W | H | peso netto<br><i>net weight</i><br>(kg) | peso lordo<br><i>gross weight</i><br>(kg) | volume imballo<br><i>package volume</i><br>(m <sup>3</sup> ) |
|---|---|---|-----|---|---|---|--|
| Barre di irrigidimento in alluminio anodizzato nero per le versioni autoportanti nella misura larga cm 240, da altezza minima 135 cm sino all'altezza massima 180 cm.<br><i>Black anodised aluminium reinforcement bars The system can also be used to construct free-standing compositions: in width 240 cm, from a height of minimum 135 cm up to the maximum height of 180 cm the system is complete with black anodised aluminium reinforcement bars.</i> | <b>ACC/N</b><br>versione<br>vetro<br><i>glass version</i> |   |     |   | 2                                       | 3   | 0,01   |
|   | <b>ACC/NL</b><br>versione<br>legno<br><i>wood version</i> |   |     |   | 2                                       | 3   | 0,01   |

Altezza massima per le strutture autoportanti  
Su basi di lunghezza 120 cm: h max 48 cm (vetro) o 51 cm (legno)  
Su basi di lunghezza 180 cm: h max 135 cm (vetro) o 143 cm (legno)  
Su basi di lunghezza 240 cm: h 178 cm (vetro) o 189 cm (legno)  
con accessorio dedicato  
Altezza massima per le strutture con ancoraggio a muro:  
massimo 5 ripiani totali, base esclusa.

*Max. height of the free-standing version  
With base length 120 cm: h max 48 cm (glass) or 51 cm (wood)  
With base length 180 cm: h max 135 cm (glass) or 143 cm (wood)  
With base length 240 cm: h max 178 (glass) or 189 cm (wood)  
with accessories  
Max. height of the wall version:  
max 5 shelves, base excluded.*



di serie \_ standard

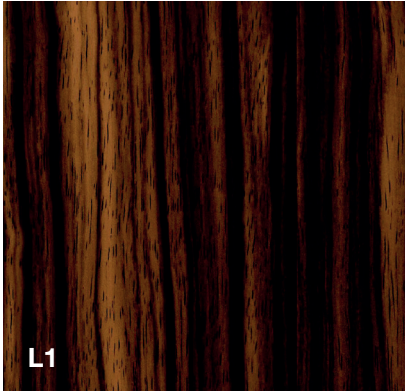

L1

**Ebano laccato lucido**  
Glossy lacquered ebony

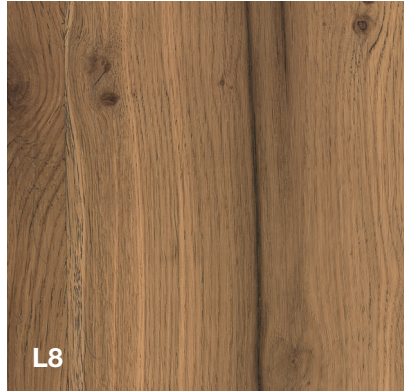

L8

**Rovere "old"**  
"Old style" oak

su richiesta \_ on request



L7

**Noce canaletto**  
Canaletto walnut

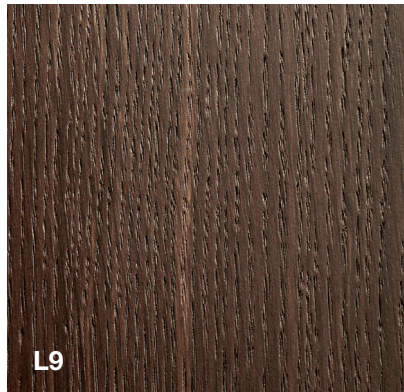

L9

**Rovere termotrattato**  
Heat-treated oak

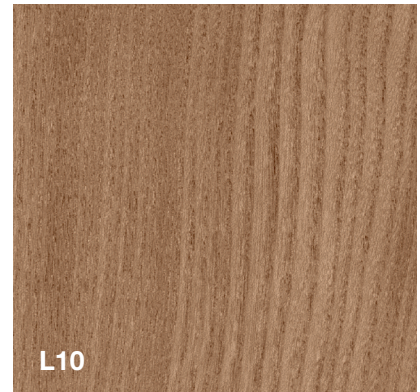

L10

**Olmo**  
Elm