

RETRÒ 1

M. Marconato - T. Zappa

Tavolo da pranzo con base in massello di noce canaletta. Insetto in metallo e piano tondo in cristallo bisellato (spessore mm. 15).

Dining-table with base in solid canaletta walnut. Metal central structure and bevelled glass top (thickness mm. 15).

Ess-Tisch mit Gestell aus massivem Nussbaum Canaletta. Metallverbindung und Glasplatte (mit einer Stärke von mm. 15).

Table à manger avec piétement en noyer canaletta massif. Joint en métal et plateau en verre (épaisseur mm. 15).

Mesa de comedor con base en nogal canaletta macizo. Inserción en metal y tapa en cristal biselado (espesor mm. 15).

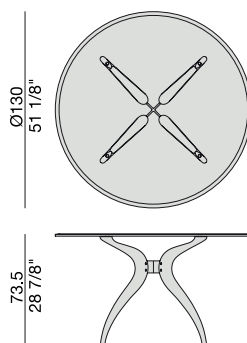

ESSENZE | *Essences*



Noce Canaletta
Canaletta Walnut



Noce Canaletta
Canaletta Walnut
tinto/stained moka



Noce Canaletta
Canaletta Walnut
tinto/stained wengé

LACCATO OPACO PORO CHIUSO | *Matt lacquered closed pore*

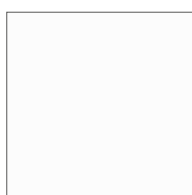

Bianco
White
(RAL 9016)



Avorio
Ivory
(RAL 1013)



Argilla
Mud
(RAL 7006)



Piombo
Lead
(NCS S5005G20Y)



Cioccolato
Chocolate
(RAL 8019)

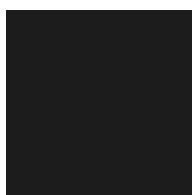

Nero
Black
(RAL 9005)



Granata
Garnet red
(NCS S4050Y90R)



Pistacchio
Pistachio green
(PANTONE 5825)



Avio
Aviation blue
(PANTONE 5415)

RETRÒ 1

M. Marconato - T. Zappa

CRISTALLO | *Glass*

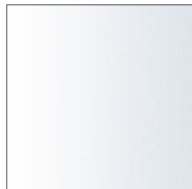

Trasparente
Transparent

METALLO | *Metal*

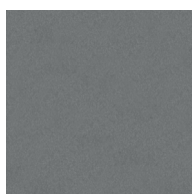

Grigio Peltro
Grey Pewter

RETRÒ 2

M. Marconato - T. Zappa

Tavolo da pranzo con base in massello di noce canaletta. Inserto in metallo e piano ovale in cristallo bisellato (spessore mm. 15).

Dining-table with base in solid canaletta walnut. Metal central structure and bevelled glass top (thickness mm. 15).

Ess-Tisch mit Gestell aus massivem Nussbaum Canaletta. Metallverbindung und Glasplatte (mit einer Stärke von mm. 15).

Table à manger avec piétement en noyer canaletta massif. Joint en métal et plateau en verre (épaisseur mm. 15).

Mesa de comedor con base en nogal canaletta macizo. Inserción en metal y tapa en cristal biselado (espesor mm. 15).

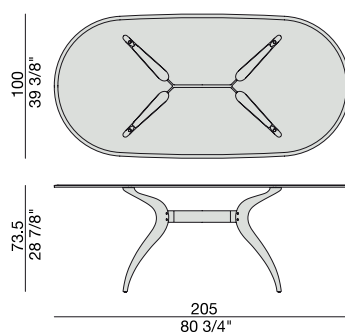

RETRÒ 2

M. Marconato - T. Zappa

ESSENZE | *Essences*



Noce Canaletta
Canaletta Walnut

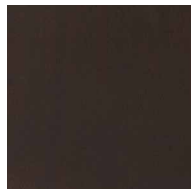

Noce Canaletta
Canaletta Walnut
tinto/stained moka



Noce Canaletta
Canaletta Walnut
tinto/stained wengé

LACCATO OPACO PORO CHIUSO | *Matt lacquered closed pore*

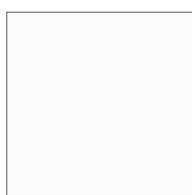

Bianco
White
(RAL 9016)

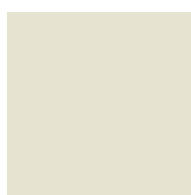

Avorio
Ivory
(RAL 1013)



Argilla
Mud
(RAL 7006)



Piombo
Lead
(NCS S5005G20Y)



Cioccolato
Chocolate
(RAL 8019)

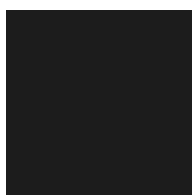

Nero
Black
(RAL 9005)



Granata
Garnet red
(NCS S4050Y90R)



Pistacchio
Pistachio green
(PANTONE 5825)



Avio
Aviation blue
(PANTONE 5415)

RETRÒ 2

M. Marconato - T. Zappa

CRISTALLO | *Glass*

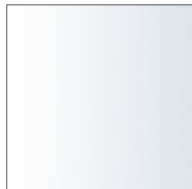

Trasparente
Transparent

METALLO | *Metal*

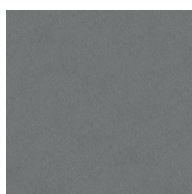

Grigio Peltro
Grey Pewter

RETRÒ 4

M. Marconato - T. Zappa

Tavolo da pranzo con base in massello di noce canaletta. Inserto in metallo e piano a botte in cristallo bisellato (spessore mm. 15).

Dining-table with base in solid canaletta walnut. Metal central structure and bevelled glass top (thickness mm. 15).

Ess-Tisch mit Gestell aus massivem Nussbaum Canaletta. Metallverbindung und Glasplatte (mit einer Stärke von mm. 15).

Table à manger avec piètement en noyer canaletta massif. Joint en métal et plateau en verre (épaisseur mm. 15).

Mesa de comedor con base en nogal canaletta macizo. Inserción en metal y tapa en cristal biselado (espesor mm. 15).

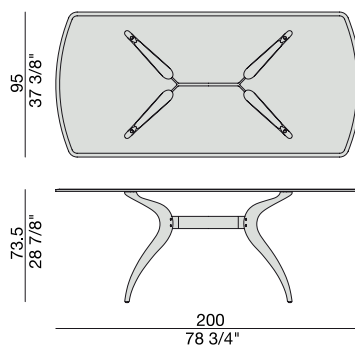

RETRÒ 4

M. Marconato - T. Zappa

ESSENZE | *Essences*



Noce Canaletta
Canaletta Walnut

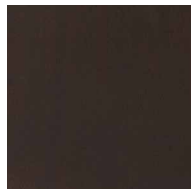

Noce Canaletta
Canaletta Walnut
tinto/stained moka



Noce Canaletta
Canaletta Walnut
tinto/stained wengé

LACCATO OPACO PORO CHIUSO | *Matt lacquered closed pore*

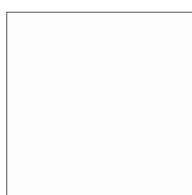

Bianco
White
(RAL 9016)

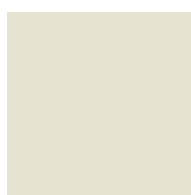

Avorio
Ivory
(RAL 1013)



Argilla
Mud
(RAL 7006)



Piombo
Lead
(NCS S5005G20Y)



Cioccolato
Chocolate
(RAL 8019)

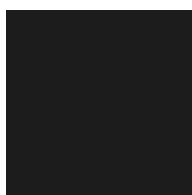

Nero
Black
(RAL 9005)



Granata
Garnet red
(NCS S4050Y90R)



Pistacchio
Pistachio green
(PANTONE 5825)



Avio
Aviation blue
(PANTONE 5415)

RETRÒ 4

M. Marconato - T. Zappa

CRISTALLO | *Glass*

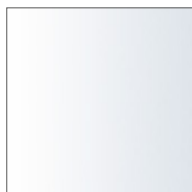

Trasparente
Transparent

METALLO | *Metal*

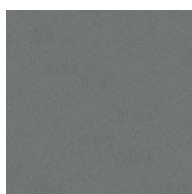

Grigio Peltro
Grey Pewter