

Jack

DESIGN STUDIO MARELLI
2009



marelli

PIVOT swivel armchairs
9PIV101 cm 55,5x54x80h
 Wooden structure: OPR15 Moka matt stained oak
 Seat and back: leather cat. Super art. Dollaro 7140

MIKE table
7MK104 cm 240x100x73h
 Wooden base and top: OPR15 Moka matt stained oak

CHLOÉ armchairs
9CHL101 cm 72x71x78h
 Wooden structure: OPR15 Moka matt stained oak
 Seat and back: fabric cat. G art. Yuma 7011.18 by Vescom

THOR tables
7TH101 cm 80x80x19h
 OPP2 matt Marquinia black marble

CLIP coffee tables
7CL118 ø cm 40x50h
7CL117 ø cm 40x40h
 Metal base and top: OPM14 shiny black chrome



JACK110 sofa composition
cm 305x110
 Fabric: cat. C art. Carlos col. 212
 Metal feet: version "D" OPM9 classic bronze painted

Cushions:
9JK105 cm 45x45
9CU105 cm 50x50
 Fabric: cat. C art. Carlos col. 212

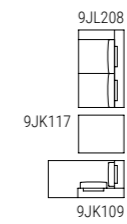

JACK110 sofa composition
cm 403x200
 Fabric: cat. C art. Carlos col. 212
 Metal feet: version "D" OPM9 classic bronze painted

Cushions:
9JK105 cm 45x45
9CU105 cm 50x50
 Fabric: cat. C art. Carlos col. 212



JACK100 sofa
9JK301 cm 250x100x87h
Fabric: cat. E art. Rustico col. 9106 by Fidivi
Metal feet: version "A" OPM1 shiny chrome

Cushions:
9JK105 cm 45x45
Fabric: cat. E art. Rustico col. 9106 by Fidivi

FRAME server
7FR110 cm 55x27x51,5h
Metal base: OPM2 brushed matt chrome
Glass top: OPV6 RAL 1019 grey beige back-painted





BREAK DINING TABLE

7BR209 cm 240x110x74h
Metal base: OPM13 brushed antique brass
Marble top: OPP2 shiny Marquinia black

CHIA armchairs

9CH103 cm 58x53x77h
Metal base: version "A" OPM6 RAL 9017 black painted
Leather: cat. Super art. Panama 5300

CLIP coffee tables

7CL118 ø cm 40x50h
7CL117 ø cm 40x40h
Metal base and top: OPM14 shiny black chrome

FRAME coffee table

7FR121 ø cm 100x28h
Metal base: OPM14 shiny black chrome
Marble top: OPP7 shiny Calacatta gold

THOR table

7TH102 cm 100x100x19h
OPP7 matt Calacatta gold marble

LEAF server

7LE101 cm 64x25x51h
Metal base and top: OPM16 shiny brass chrome

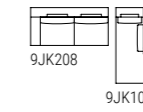
**JACK100** sofa composition

cm 303x200
Fabric: cat. E San Matteo 17
Metal feet: "D" version OPM15 brushed antique gold

Cushions:

9JK105 cm 45x45
Fabric: San Matteo 17
9JK105 cm 45x45
Leather: cat. Super Dollaro 7140



LEAF server
7LE101 cm 64x25x51h
Metal base and top: OPM16 shiny brass chrome



LEAF server
7LE101 cm 64x25x51h
 Metal base and top: 0PM16 shiny brass chrome

FRAME coffee table
7FR121 ø cm 100x28h
 Metal base: 0PM14 shiny black chrome
 Marble top: 0PP7 shiny Calacatta gold

BREAK coffee table
7BR115 ø cm 60x36h
 Metal base and top: 0PM3 brushed matt dark grey

THOR table
7TH102 cm 100x100x19h
 0PP7 matt Calacatta gold marble

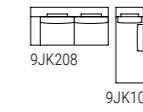

JACK100 sofa composition
cm 303x200
 Fabric: cat. E San Matteo 17
 Metal feet: "D" version - 0PM15 brushed antique gold

Cushions:
9JK105 cm 45x45
 Fabric: San Matteo 17
9JK105 cm 45x45
 Leather: cat. Super Dollaro 7140



Jack100

DESIGN STUDIO MARELLI
2009

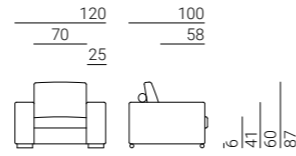

Divani
Sofas

Elementi componibili
Modular elements

Divani letto
Sofa-beds

Dormeuse
Longchair

Pouf e accessori
Pouf and accessories

Piedini
Feet

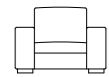

9JK101
L110 P100 H87



9JK205
L100 P100 H87

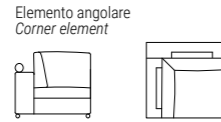

9JK104
L100 P100 H87

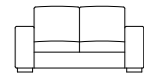

9JK201
L170 P100 H87

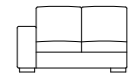

9JK115
L145 P100 H87

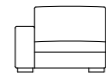

9JK114
L120 P100 H87



9JK209
L100 P100 H87

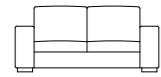

9JK202
L190 P100 H87

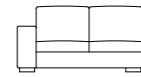

9JK206
L165 P100 H87

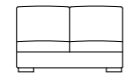

9JK210
L140 P100 H87

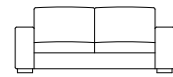

9JK203
L210 P100 H87



9JK207
L185 P100 H87

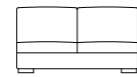

9JK211
L160 P100 H87



9JK204
L230 P100 H87

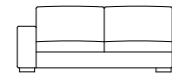

9JK208
L205 P100 H87



9JK212
L180 P100 H87



9JK301
L250 P100 H87

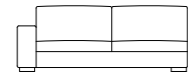

9JK302
L225 P100 H87



9JK303
L200 P100 H87

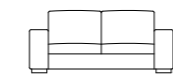

9JK214
L190 P100 H87

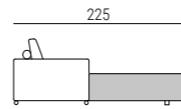

**Materasso
Mattress**
L110 P190 H15



9JK215
L210 P100 H87

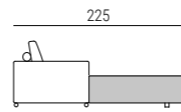

**Materasso
Mattress**
L115 P190 H15

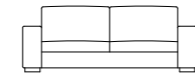

9JK216
L230 P100 H87

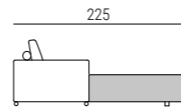

**Materasso
Mattress**
L145 P190 H15

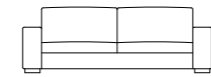

9JK304
L250 P100 H87

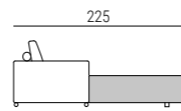

**Materasso
Mattress**
L160 P190 H15



9JK217
L185 P100 H87

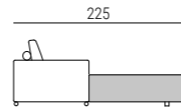

**Materasso
Mattress**
L115 P190 H15



9JK218
L205 P100 H87

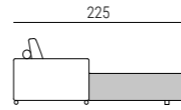

**Materasso
Mattress**
L145 P190 H15



9JK219
L225 P100 H87

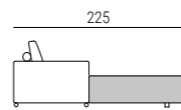

**Materasso
Mattress**
L160 P190 H15

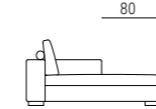

9JK102
L180 P98 H87

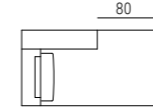

9JK108
L180 P98 H87

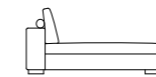

9JK103
L200 P98 H87

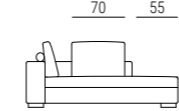

9JK109
L200 P98 H87

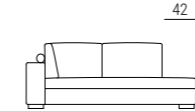

9JK113
L225 P98 H87



9JK110
L100 P75 H41

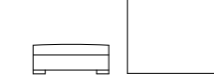

9JK117
L100 P120 H41

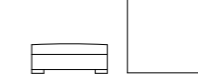

9JK111
L100 P100 H41



9JK105
L45 H45
Cuscinetto in piuma con fascia
Feather cushion with band



9CU103
L40 H40
Cuscinetto in piuma senza fascia
Feather cushion without band



9JK401
L70 H50
Cuscino con rullo
Cushion with bolster

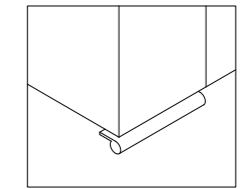

Versione A (standard)
in metallo
Version A (standard)
in metal

H 6 cm

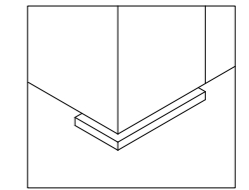

Versione B
in metallo
Version B
in metal

H 5,5 cm

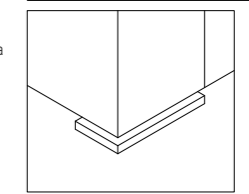

Versione C
in legno
Version C
in wood

H 5,5 cm

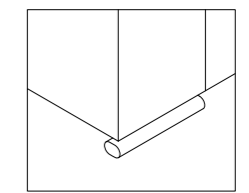

Versione D
in metallo
Version D
in metal

H 6,5 cm

Jack 110/120

DESIGN STUDIO MARELLI
2009

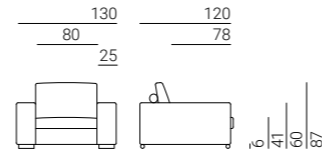

Tutti i divani, divani letto e gli elementi componibili di Jack 120 (profondità di 120 cm) sono disponibili anche nella profondità di 110 cm (Jack 110).
All the sofas, sofa-beds and modular elements of Jack 120 (120 cm depth), are available in the depth of 110 cm (Jack 110).

Divani Sofas

Elementi componibili Modular elements

Divani letto Sofa-beds

Dormeuse Longchair

Pouf e accessori Pouf and accessories

Piedini Feet

Elemento angolare Corner element

 9JL101 L130 P120 H87	 9JL205 L120 P120 H87	 9JL103 L120 P120 H87	 9JL209 L100 P120 H87	 9JL214 L190 P120 H87	 9JL214 L190 P120 H87 Materasso Mattress L110 P190 H15
 9JL202 L190 P120 H87	 9JL206 L165 P120 H87	 9JL210 L140 P100 H87	 9JL215 L210 P120 H87	 9JL215 L210 P120 H87	 9JL215 L210 P120 H87 Materasso Mattress L115 P190 H15
 9JL203 L210 P120 H87	 9JL207 L185 P120 H87	 9JL211 L160 P100 H87	 9JL216 L230 P120 H87	 9JL216 L230 P120 H87	 9JL216 L230 P120 H87 Materasso Mattress L145 P190 H15
 9JL204 L230 P120 H87	 9JL208 L205 P120 H87	 9JL212 L180 P100 H87	 9JL304 L250 P120 H87	 9JL304 L250 P120 H87	 9JL304 L250 P120 H87 Materasso Mattress L160 P190 H15
 9JL301 L250 P120 H87	 9JL302 L225 P120 H87	 9JL303 L200 P100 H87	 9JL217 L185 P120 H87	 9JL217 L185 P120 H87	 9JL217 L185 P120 H87 Materasso Mattress L115 P190 H15
			 9JL218 L205 P120 H87	 9JL218 L205 P120 H87	 9JL218 L205 P120 H87 Materasso Mattress L145 P190 H15
			 9JL219 L225 P120 H87	 9JL219 L225 P120 H87	 9JL219 L225 P120 H87 Materasso Mattress L160 P190 H15

 9JK108 L180 P98 H87	 9JK103 L200 P98 H87	 9JK109 L200 P98 H87	 9JK113 L225 P98 H87
-----------------------------------	-----------------------------------	-----------------------------------	-----------------------------------











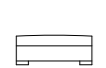

 9JK110 L100 P75 H41	 9JK105 L45 H45 Cuscinetto in piuma con fascia Feather cushion with band	 9JK117 L100 P120 H41	 9JF102 L80 H40 Cuscino in piuma con fascia Feather cushion with band
 9JK111 L100 P100 H41	 9JU103 L40 H40 Cuscinetto in piuma senza fascia Feather cushion without band	 9JK401 L70 H50 Cuscino con rullo Cushion with bolster	

 Versione A (standard) in metallo Version A (standard) in metal	H 6 cm
 Versione B in metallo Version B in metal	H 5,5 cm
 Versione C in legno Version C in wood	H 5,5 cm
 Versione D in metallo Version D in metal	H 6,5 cm

Jack

DESIGN STUDIO MARELLI
2009







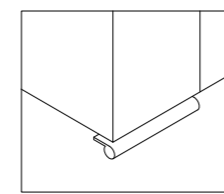
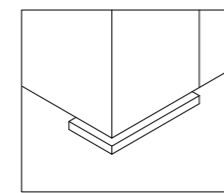
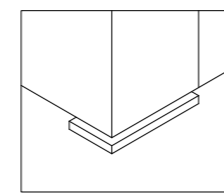
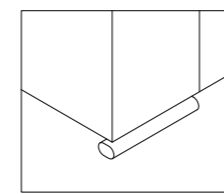







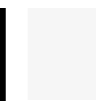





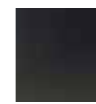

Pouf e accessori
Pouf and accessories

		
9JK110 L100 P75 H41	9JK105 L45 H45 Cuscinetto in piuma con fascia <i>Feather cushion with band</i>	
		
9JK117 L100 P120 H41	9JK117 L80 H40 Cuscino in piuma con fascia <i>Feather cushion with band</i>	
		
9JK111 L100 P100 H41	9CU103 L40 H40 Cuscinetto in piuma senza fascia <i>Feather cushion without band</i>	
		
9JF101 L100 P125 H41	9JK401 L70 H50 Cuscino con rullo <i>Cushion with bolster</i>	

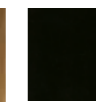
Piedini
Feet

	Versione A (standard) in metallo Version A (standard) in metal	H 6 cm
	Versione B in metallo Version B in metal	H 5,5 cm
	Versione C in legno Version C in wood	H 5,5 cm
	Versione D in metallo Version D in metal	H 6,5 cm

Finiture piedini
Feet finishes

Versione A-B-D <i>Version A-B-D</i>										
Code	Shiny chrome metal OPM1	Brushed matt chrome metal OPM2	Brushed matt dark grey metal OPM3	RAL 9017 black painted metal OPM6	RAL 9016 white painted metal OPM7	Classic bronze painted metal OPM9	Golden beach painted metal OPM10	Gold pearl painted metal OPM11	Brushed copper metal OPM12	Brushed antique brass metal OPM13
										
Code	Shiny black chrome metal OPM14	Brushed antique gold metal OPM15	Shiny brass chrome metal OPM16	Bronze metal OPM17						
Versione C <i>Version C</i>										
Code	Cherry stained beech OPF1	Wengé stained beech OPF2	Walnut stained beech OPF3	Natural beech OPF4	Black stained beech OPF5	Cherry Milano stained beech OPF6	Tobacco stained beech OPF8	Grey taupe stained beech OPF9	Charcoal stained beech OPF11	Mahogany stained beech OPF12

Jack

DESIGN STUDIO MARELLI
2009

Fusto in legno massello e legno multistrato con cinghie elastiche intrecciate. Imbottitura in poliuretano espanso rivestito in vellutino bianco. Cuscini di schienale in Piumafib, una speciale miscela ipoallergenica di vera piuma e fibra poliestere siliconata con inserto in gomma con densità 30 kg/m³*. Cuscini di seduta costituiti da un inserto in poliuretano con densità di 30 Kg/m³ ricoperto da un trapuntino di vera piuma imbottito a scomparti*. Completamente sfoderabile in tessuto, non sfoderabile in pelle e finta pelle.

Kit letto disponibile. Disponibile con profondità di seduta 100/110/120 cm

*Manutenzione dei cuscini contenenti piuma:

I cuscini contenenti piuma tendono a deformarsi con l'utilizzo. Per mantenerne la forma è necessario, anche dopo un breve utilizzo, battere e sprimacciare ripetutamente i cuscini. Non utilizzare mai battipanni o aspirapolvere. A coloro che non desiderassero seguire queste indicazioni o che volessero un divano dall'aspetto meno vissuto, raccomandiamo di preferire dei cuscini in gomma.

Carcasse en bois massif et multiplis muni de bandes élastiques entrecroisées et finie de mousse polyuréthane couverte de dacron. Coussins de dossier en Piumafib, un mélange hypoallergénique spécial de véritable duvet et fibre polyester siliconisée avec un noyau en mousse polyuréthane d'une densité de 30 kg/m³. Les coussins d'assise sont composés d'un noyau en mousse polyuréthane d'une densité de 30 kg/m³ couvert de véritable duvet broché en compartiments*. Revêtement complètement déhoussable en tissu, fixe en cuir et cuir look.*

Disponibile in canapé-lit. Profondeurs d'assise disponibles: cm 100/110/120

*Entretien de coussins en duvet:

Coussins en duvet ont tendance à perdre leur forme dû à l'usage. Pour en conserver la forme il est nécessaire, aussi après un usage court, de régulièrement battre les coussins. Ne jamais utiliser la tapette ou l'aspirateur. A ceux qui ne désirent pas suivre ces indications ou qui souhaitent un canapé qui ait l'air moins "usé", nous conseillons vivement de choisir des coussins en mousse polyuréthane.

Frame made of solid wood and multi-ply wood with interwoven elastic straps. The upholstery is made of polyurethane foam, covered with dacron. The back cushions are filled with Piumafib, a special hypoallergenic mixture of feathers and siliconised polyfibre with a foam insert with density of 30 kg/m³. The seat cushions are made of a foam insert with density of 30 Kg/m³, covered with a feather compartments quilt*. Fully removable fabric covers, fixed leather and artificial leather covers.*

Sofa-bed is available. Available seat depths: 100/110/120 cm

*Maintenance of feather cushions:

Cushions filled with feathers tend to change their shape with use. In order to keep their shape it is necessary, even after a short use, to plump up the cushions repeatedly. Never use carpet beater or vacuum cleaner. We recommend to choose foam cushions to those who do not wish to follow these instructions or to have a "used look" sofa.

Для производства каркаса используется массив дерева и многослойная фанера в сочетании с перекрещивающимися эластичными ремнями. Наполнение из полиуретана, обернутого в белый бархат. Наполнение подушек спинки выполнено из материала Piumafib – специальной, не вызывающей аллергии смеси из натурального пуха и полиэфирных силиконовых волокон со вставкой из полиуретана плотностью 30 кг/м³. Подушки сиденья: стеганые по отсекам, наполнение из натурального пуха с вставками из полиуретана плотностью 30 кг/м³*. Полностью съемные чехлы из ткани, несъемные чехлы из кожи.*

Исполнение дивана в версии со спальным местом: возможно

Возможные варианты по глубине: 100/110/120см

*Эксплуатация подушек с пуховым наполнением:

В процессе эксплуатации подушки с пуховым наполнением могут деформироваться, во избежание чего их необходимо слегка взбивать вручную даже после непродолжительного нахождения на диване. Использование в этих целях пылесоса или выбивалки для одежды категорически запрещено. Если клиент не планирует следовать данным инструкциям и хочет, чтобы подушки сиденья и спинки проминались по минимуму, посоветуйте выбрать наполнение только из полиуретана, полностью исключив натуральный пух.

Das Gestell besteht aus Massiv- und Schichtholz, mit geflochtenen Gummigurten, gepolstert mit Polyurethanschaumstoff, mit Dacron bezogen. Rueckenkissen aus Piumafib, einer hypoallergischen speziellen Mischung aus echter Daune und silikonisierter Polyesterfaser mit einem Schaumkern mit Dichte 30 kg/m³. Die Sitzkissen bestehen aus einem Schaumkern mit Dichte 30 Kg/m³ mit einer gekammerten Daunenauflege*. Stoffbezüge alle abziehbar, Leder und Kunstleder festbezogen.*

Als Bettsofa verfügbare. Lieferbare Sitztiefen: 100/110/120 cm

Wartungsanleitungen fuer Daunenkissen:

Die Kissen, die Daunen enthalten, neigen dazu, sich durch Gebrauch zu verformen. Um die urspruengliche Form zu halten, ist es notwendig, auch nach kurzem Gebrauch, die Kissen wiederholt aufzuschuettern. Keinen Ausklopfen oder Staubsauger verwenden. Unseren Kunden, die diese Anweisungen nicht befolgen moechten, oder die kein Sofa mit solchem "gebrauchten" Aussehen haben moechten, empfehlen wir Polyurethan-Kissen.