

ONDEA

design Sacha LAKIC

rochebobois
PARIS



ONDEA

design Sacha LAKIC

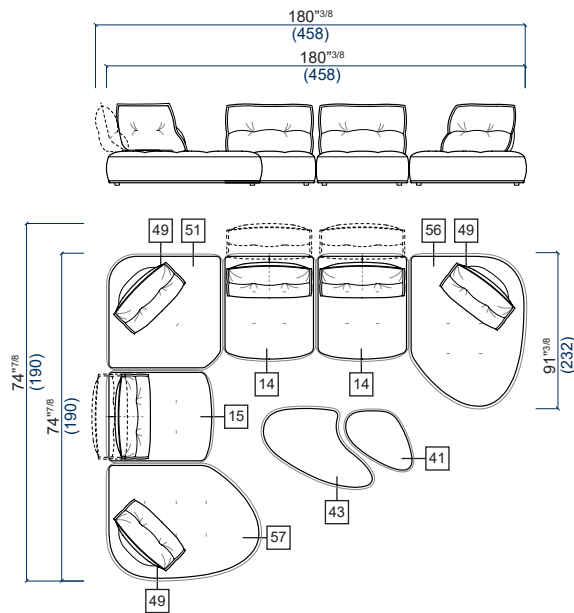

- 57** Grand Pouf terminal arrondi gauche
Large round end-ottoman - Left
Gran Pouf terminal redondeado izquierdo
- 56** Grand Pouf terminal arrondi droit
Large round end-ottoman - Right
Gran Pouf terminal redondeado derecho
- 51** Pouf d'angle
Corner ottoman
Puf de ángulo
- 49** Dossier indépendant
Independent backrest
Respaldo independiente
- 14** Chauffeuse - dossier mécanisme grand débattement
Armless chair - backrest with long path mechanism
Chauffeuse - respaldo mecanismo movimiento amplio
- 15** Chauffeuse - dossier mécanisme petit débattement
Armless chair - backrest with short path mechanism
Chauffeuse - respaldo mecanismo movimiento corto
- 43** Grand Pouf gauche
Large ottoman - Left
Gran Pouf izquierdo
- 41** Pouf gauche
Ottoman - Left
Puf izquierdo

ONDEA

rochebobois
PARIS

design Sacha LAKIC



FICHE TECHNIQUE / TECHNICAL SPECIFICATIONS / FICHA TECNICA:

Structure : Sapin massif, multiplis de pin et panneaux de particules

Suspension : Sangles élastiques HR

Garnissage assise : Mousse polyuréthane Hypersoft bi-densité 35-23 kg/m³ et fibre polyester

Garnissage dossier : Mousse polyuréthane Hypersoft bi-densité 25-21 kg/m³, fibre polyester et latex

Piètement : Hêtre massif verni teinté Wengé

Structure: Solid fir wood, pine plywood and engineered composite wood

Suspension: HR elastic straps

Seat cushion: Hypersoft bi-density polyurethane foam 35-23 kg/m³ and polyester fibre

Back cushion: Hypersoft bi-density polyurethane foam 25-21 kg/m³, polyester fibre and latex

Base: Solid beech wood with varnish stain finish, col. Wenge

Estructura: Abeto macizo, multilaminado de pino y paneles de partículas

Suspensión: Cinchas elásticas HR

Interior asiento: Espuma poliuretano Hypersoft bi-densidad 35-21 kg/m³ y fibra poliéster

Interior respaldo: Espuma poliuretano Hypersoft bi-densidad 25-21 kg/m³, fibra poliéster y látex

Patatas: Haya maciza barniz tintado Wengué

OBSERVATIONS / OBSERVATIONS / OBSERVACIONES :

- Fabrication Européenne
- Assise et dossier capitonnés
- Dossier à double profondeur avec mécanisme à balancier disponible avec grand débattement (42 cm) ou petit débattement (25 cm)
- Modèle réalisable dans l'ensemble des tissus de la collection Roche Bobois, à l'exception des tissus Techno 2D, Techno 3D et Techno 4D, à motifs ou à rayures (avec raccords) et des velours. Poufs 41, 42, 43, 44 et dossier indépendant réalisables dans l'ensemble des tissus de la collection Roche Bobois, à l'exception des tissus Techno 2D, 3D et 4D
- Modèle non réalisable en cuir

- Manufactured in Europe
- Padded seat and backrest
- Double depth backrest with integrated adjustable mechanism available with long path (42cm) or short path (25cm)
- This model is available in all fabrics from the Roche Bobois collection, with the exception of the Techno 2D, Techno 3D, Techno 4D, striped and patterned fabrics (with repeat) and velvets. Ottomans 41, 42, 43, 44 and independent backrest are available in all fabrics from the Roche Bobois collection, with the exception of the Techno 2D, 3D and 4D fabrics
- This model is not available in leather

- Fabricación europea
- Asiento y respaldo capitoné
- Respaldo de doble profundidad con mecanismo a balancín disponible con movimiento amplio (42cm) o movimiento corto (25cm)
- Modelo realizable en todas las telas de la colección Roche Bobois, excepto con las telas Techno 2D, Techno 3D, Techno 4D, las telas con motivos y rayadas (con racords) y los terciopelos. Pufs 41, 42, 43, 44 y respaldo independiente realizables en todas las telas de la colección Roche Bobois, excepto con las telas Techno 2D, 3D y 4D
- Modelo no realizable en piel

design Sacha LAKIC

DIMENSIONS COMMUNES A TOUS LES ELEMENTS / SAME DIMENSIONS FOR ALL ELEMENTS / MEDIDAS COMUNES A TODOS LOS ELEMENTOS

Les dimensions reportées (profondeur et hauteur de l'élément, profondeur et hauteur de l'assise, largeur des accoudoirs) sont communes à tous les éléments.

The dimensions below (depth and height of the element, depth and height of the seat cushion, width of the armrests) are the same for all elements.

Las medidas mencionadas (profundidad y altura del elemento, profundidad y altura del asiento, ancho de los apoyabrazos), son comunes a todos los elementos.

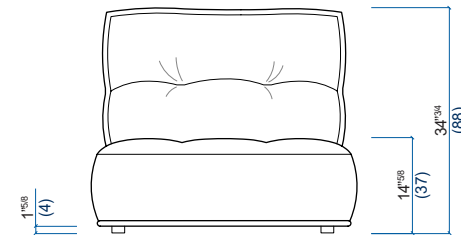

CHAUFFEUSE - DOSSIER AVEC MECANISME A BALANCIER GRAND DEBATTEMENT
ARMLESS CHAIR - BACKREST WITH LONG PATH MECHANISM
CHAUFFEUSE - RESPALDO CON MECANISMO MOVIMIENTO AMPLIO

CHAUFFEUSE - DOSSIER AVEC MECANISME A BALANCIER PETIT DEBATTEMENT
ARMLESS CHAIR - BACKREST WITH SHORT PATH MECHANISM
CHAUFFEUSE - RESPALDO CON MECANISMO MOVIMIENTO CORTO

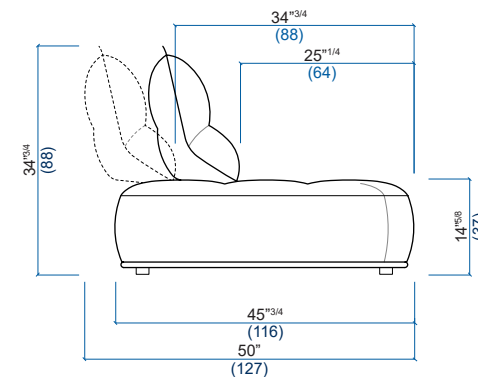
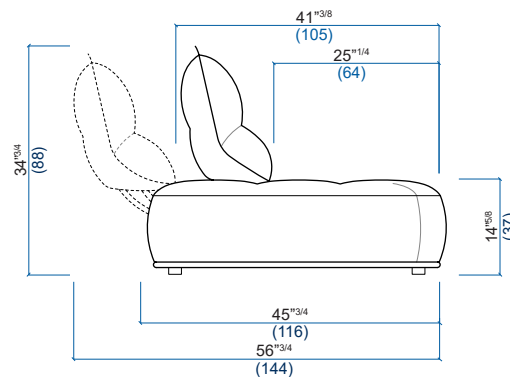

design Sacha LAKIC

DOSSIER MECANISME GRAND DEBATTEMENT / BACKREST WITH LONG PATH MECHANISM / RESPALDO MECANISMO MOVIMIENTO AMPLIO

14 Chauffeuse
Armless chair
Chauffeuse

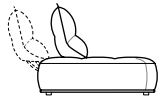
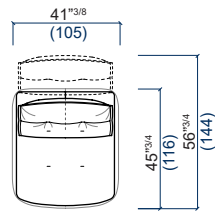

54 Chaise longue
Lounge chair
Chaise longue

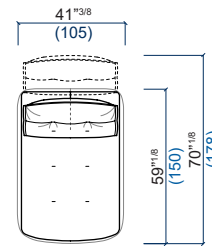

DOSSIER MECANISME PETIT DEBATTEMENT / BACKREST WITH SHORT PATH MECHANISM / RESPALDO MECANISMO MOVIMIENTO CORTO

15 Chauffeuse
Armless chair
Chauffeuse

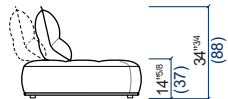
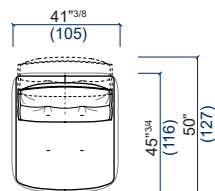

55 Chaise longue
Lounge chair
Chaise longue

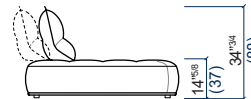
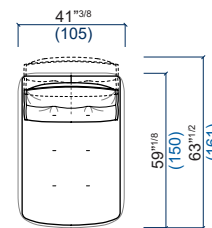

design Sacha LAKIC

57 Grand Pouf terminal arrondi gauche
Large round end-ottoman - Left
Gran Puf terminal redondeado izquierdo

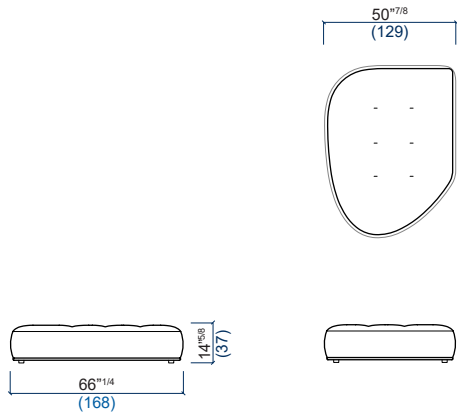

56 Grand Pouf terminal arrondi droit
Large round end-ottoman - Right
Gran Puf terminal redondeado derecho

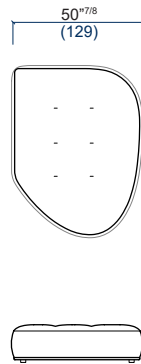

51 Pouf d'angle
Corner ottoman
Puf de ángulo

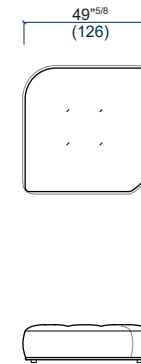

40 Pouf carré
Square ottoman
Puf cuadrado

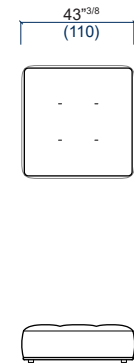

49 Dossier indépendant
Independent backrest
Respaldo independiente

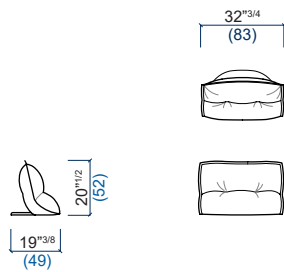

design Sacha LAKIC

43 Grand Pouf gauche
Large ottoman - Left
Gran Puf izquierdo

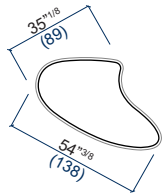

44 Grand Pouf droit
Large ottoman - Right
Gran Puf derecho

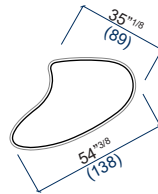

41 Pouf gauche
Ottoman - Left
Puf izquierdo

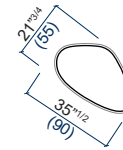

42 Pouf droit
Ottoman - Right
Puf derecho

