

# SATELLITE 2

rochebobois  
PARIS

design Sacha LAKIC



# SATELLITE 2

design Sacha LAKIC

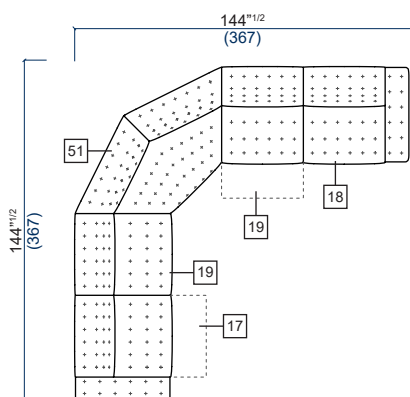

**17** Bâtard 1 place gauche "Full Relax" avec mécanisme multipositions  
1-seat 1-arm unit left armrest "Full Relax" with multi-position mechanism  
Batard 1 plaza izquierdo "Full Relax" con mecanismo de multiposición

**18** Bâtard 1 place droit appuie-tête relevable avec mécanisme manuel  
1-seat 1-arm unit right armrest with adjustable headrest manual mechanism  
Batard 1 plaza derecho con cabezal elevable mecanismo manual

**51** Grand angle panoramique  
Large panoramic corner-unit  
Gran ángulo panorámico

**19** Élément central appuie-tête relevable avec mécanisme manuel  
Central element with adjustable headrest manual mechanism  
Elemento central con cabezal elevable mecanismo manual

**19** Élément central "Full Relax" avec mécanisme multipositions  
Central element "Full Relax" with multi-position mechanism  
Elemento central "Full Relax" con mecanismo de multiposición

# SATELLITE 2

design Sacha LAKIC

rochebobois  
PARIS



# SATELLITE 2

rochebobois  
PARIS

design Sacha LAKIC



## FICHE TECHNIQUE / TECHNICAL SPECIFICATIONS / FICHA TECNICA:

Structure : Sapin massif et multiplis de pin  
Suspension : Sangles élastiques HR  
Garnissage assise : Mousse polyuréthane HR bi-densité 40-45 kg/m<sup>3</sup>  
Garnissage dossier : Mousse polyuréthane HR densité 25 kg/m<sup>3</sup>  
Couette capitonnée : Fibre polyester  
Piétement : Aluminium

Structure: Solid fir wood and pine plywood  
Suspension: HR elastic straps  
Seat cushion: HR bi-density polyurethane foam 40-45 kg/m<sup>3</sup>  
Back cushion: HR polyurethane foam 25 kg/m<sup>3</sup>  
Padded duvet: Polyester fibre  
Legs: Aluminium

Estructura: Abeto macizo y multilaminado de pino  
Suspensión: Cinchas elásticas HR  
Interior asiento: Espuma poliuretano HR bi-densidad 40-45 kg/m<sup>3</sup>  
Interior respaldo: Espuma poliuretano HR densidad 25 kg/m<sup>3</sup>  
Colchoneta capitonée: Fibra poliéster  
Patatas: Aluminio

## OBSERVATIONS / OBSERVATIONS / OBSERVACIONES:

- Fabrication Européenne
- Accoudoirs et couette d'assise et de dossier capitonnés
- Modèle réalisable en cuir et dans l'ensemble des tissus de la collection Roche Bobois, à l'exception des tissus Techno 2D, Techno 3D, Techno 4D, à motifs ou à rayures (avec raccords), des velours et des microfibras
- Manufactured in Europe
- Armrests, seat and back duvet are padded
- This model is available in leather and all fabrics from the Roche Bobois collection, with the exception of Techno 2D, Techno 3D and Techno 4D fabrics, striped and patterned fabrics (with repeat), velvets and microfibras
- Fabricación europea
- Apoyabrazos y colchoneta de asiento y de respaldo capitonés
- Modelo realizable en piel y en todas las telas de la colección Roche Bobois, excepto con las telas Techno 2D, Techno 3D, Techno 4D, las telas con motivos y rayadas (con racords), los terciopelos y las microfibras

## OPTIONS / OPTIONAL / OPCIONES:

- Coutures anglaises ton sur ton ou contrastées, fil épais. Disponibles uniquement dans la version cuir
- Disponible en 2 versions :
  - "Full Relax" avec mécanisme multipositions, module de commande digitale ROCHE BOBOIS avec prise USB
  - Appuie-tête relevable avec mécanisme manuel
- Batterie lithium auxiliaire. Durée de la batterie pleine charge : 40 cycles. Durée de vie de la batterie : 300 charges
- Piétement disponibles dans 2 finitions : aluminium Brillant ou aluminium Nickel Noir. Voir page 5
- Tone-on-tone or contrasting English stitching, thick thread. Only available for the leather version
- Available in 2 versions :
  - "Full Relax" with multi-position mechanism, ROCHE BOBOIS digital command with USB port
  - Adjustable headrest with manual mechanism
- Optional lithium battery. Battery life on full charge: 40 cycles. Battery lifespan: 300 charges
- Legs available in 2 finishes: Glossy Aluminium or Black Nickel aluminium. See page 5
- Costuras inglesas tono sobre tono o contrastadas, hilo grueso. Disponibles solamente para la version en piel
- Disponible en 2 versiones:
  - "Full Relax" con mecanismo multiposición, módulo con mando digital ROCHE BOBOIS y puerto USB
  - Cabezal elevable con mecanismo manual
- Batería de litio auxiliar. Duración de la batería completamente cargada: 40 ciclos. Duración de vida de la batería: 300 cargas
- Patas disponibles en 2 acabados: aluminio Brillante o aluminio Níquel Negro. Ver página 5

# SATELLITE 2

design Sacha LAKIC

## FINITIONS PIETEMENT / LEG FINISH / ACABADO PATAS



Aluminium Brillant  
Glossy Aluminium  
Aluminio Brillante



Aluminium Nickel Noir  
Black Nickel Aluminium  
Aluminio Niquel Negro

# SATELLITE 2

design Sacha LAKIC

## COUTURES ADDITIONNELLES / ADDITIONAL STITCHING / COSTURAS ADICIONALES

Dans le cas d'un revêtement en tissu, des coutures additionnelles seront nécessaires (voir lignes rouges sur le dessin ci-dessous).

In case of fabric upholstery, additional stitching will be needed (see red marks on the drawing below).

En caso de revestimiento en tela, se necesitarán algunas costuras adicionales (ver líneas rojas en el dibujo aquí abajo).

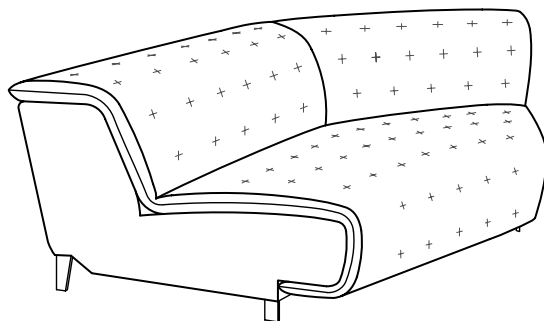

Elément 51 habillé de cuir  
Element 51 upholstered in leather  
Elemento 51 revestido en piel

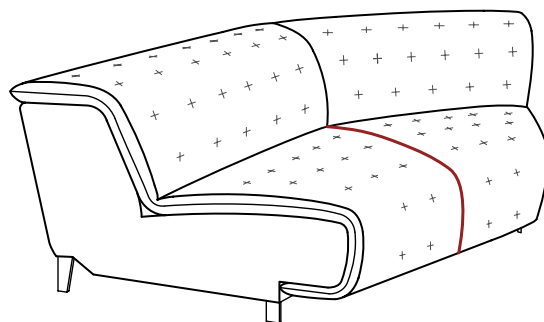

Elément 51 habillé de tissu  
Element 51 upholstered in fabric  
Elemento 51 revestido en tela

# SATELLITE 2

design Sacha LAKIC

## DIMENSIONS COMMUNES A TOUS LES ELEMENTS / SAME DIMENSIONS FOR ALL ELEMENTS / MEDIDAS COMUNES A TODOS LOS ELEMENTOS

Les dimensions reportées (profondeur et hauteur de l'élément, profondeur et hauteur de l'assise, largeur des accoudoirs) sont communes à tous les éléments.

The dimensions below (depth and height of the element, depth and height of the seat cushion, width of the armrests) are the same for all elements.

Las medidas mencionadas (profundidad y altura del elemento, profundidad y altura del asiento, ancho de los apoyabrazos), son comunes a todos los elementos.

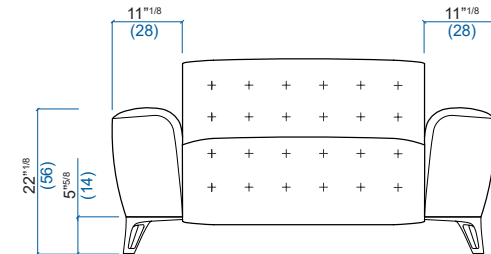

POSITION FERMEE  
CLOSED POSITION  
POSICION CERRADA

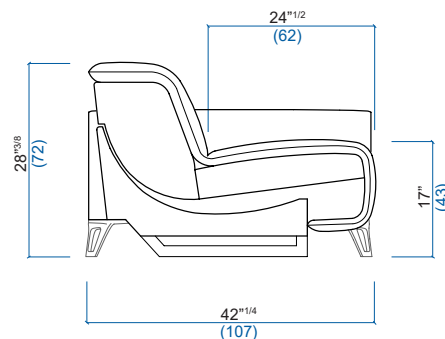

APPUIE-TETE RELEVE  
RAISED HEADREST  
CABEZAL ELEVADO

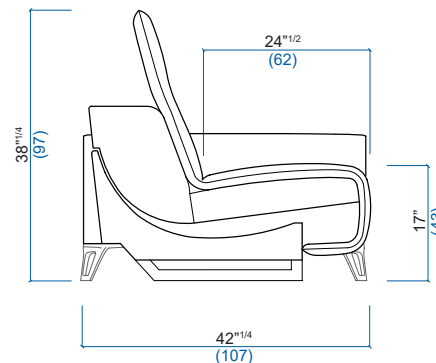

POSITION FULL-RELAX  
FULL RELAX POSITION  
POSICION FULL-RELAX

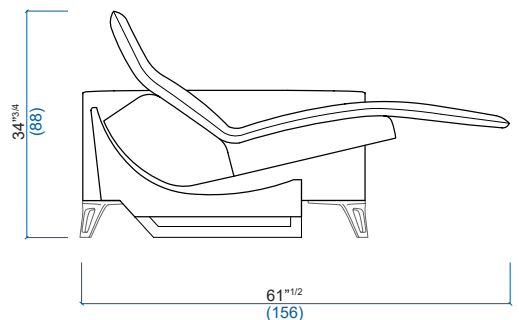

# SATELLITE 2

design Sacha LAKIC

FULL RELAX / FULL RELAX / FULL RELAX 1/2

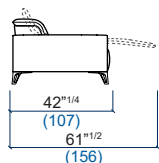

Tout élément central et angle panoramique sera nécessairement relié à 2 bâtards, un de chaque côté de l'élément

Any central element or panoramic corner-unit must be attached to a 1-arm unit on both sides

Todo elemento central y ángulo panorámico tiene que estar unido a 2 batards, uno a cada lado del elemento

08 Petit fauteuil  
Small armchair  
Pequeño sillón

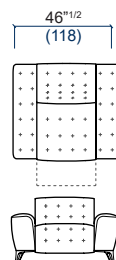

09 Fauteuil  
Armchair  
Sillón

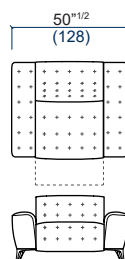

10 Grand Fauteuil  
Large armchair  
Gran Sillón

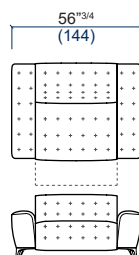

20 Canapé 2.5 places (éléments 12+13)  
2.5-seat sofa (elements 12+13)  
Sofá 2.5 plazas (elementos 12+13)

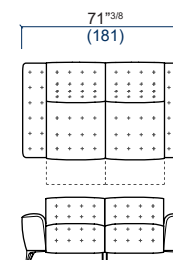

25 Canapé 3 places (éléments 15+16)  
3-seat sofa (elements 15+16)  
Sofá 3 plazas (elementos 15+16)

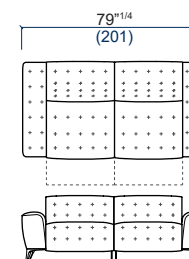

30 Grand canapé 3 places (éléments 17+18)  
Large 3-seat sofa (elements 17+18)  
Gran sofá 3 plazas (elementos 17+18)

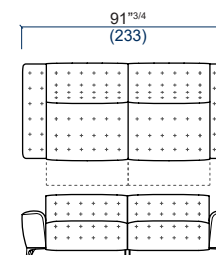



# SATELLITE 2

design Sacha LAKIC

## FULL RELAX / FULL RELAX / FULL RELAX 2/2

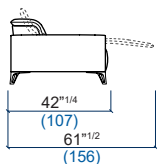

- 13** Bâtard 1 place accoudoir gauche  
1-seat 1-arm unit left armrest  
Batard 1 plaza apoyabrazo izquierdo

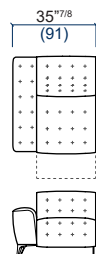

- 12** Bâtard 1 place accoudoir droit  
1-seat 1-arm unit right armrest  
Batard 1 plaza apoyabrazo derecho

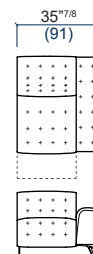

- 11** Elément central  
Central element  
Elemento central

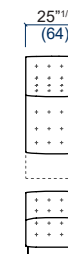

- 15** Bâtard 1 place accoudoir gauche  
1-seat 1-arm unit left armrest  
Batard 1 plaza apoyabrazo izquierdo

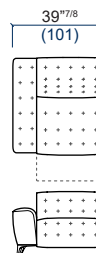

- 16** Bâtard 1 place accoudoir droit  
1-seat 1-arm unit right armrest  
Batard 1 plaza apoyabrazo derecho

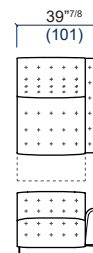

- 14** Elément central  
Central element  
Elemento central



- 17** Bâtard 1 place accoudoir gauche  
1-seat 1-arm unit left armrest  
Batard 1 plaza apoyabrazo izquierdo

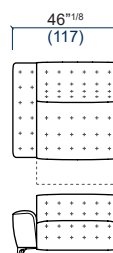

- 18** Bâtard 1 place accoudoir droit  
1-seat 1-arm unit right armrest  
Batard 1 plaza apoyabrazo derecho

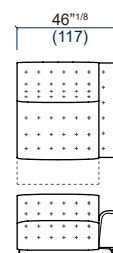

- 19** Elément central  
Central element  
Elemento central



Tout élément central et angle panoramique sera nécessairement relié à 2 bâtards, un de chaque côté de l'élément

Any central element or panoramic corner-unit must be attached to a 1-arm unit on both sides

Todo elemento central y ángulo panorámico tiene que estar unido a 2 batards, uno a cada lado del elemento

# SATELLITE 2

design Sacha LAKIC

## APPUIE-TETE RELEVABLE / ADJUSTABLE HEADREST / CABEZAL ELEVABLE 1/2



**08** Petit fauteuil  
Small armchair  
Pequeño sillón

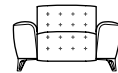
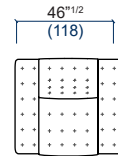

**09** Fauteuil  
Armchair  
Sillón

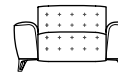
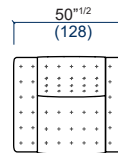

**10** Grand Fauteuil  
Large armchair  
Gran Sillón

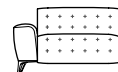
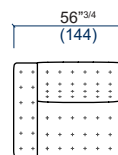

**20** Canapé 2.5 places  
2.5-seat sofa  
Sofá 2.5 plazas

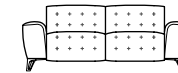
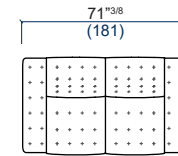

**25** Canapé 3 places  
3-seat sofa  
Sofá 3 plazas

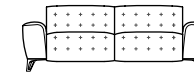
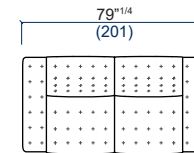

**30** Grand canapé 3 places  
Large 3-seat sofa  
Gran sofá 3 plazas

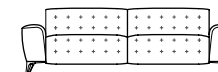
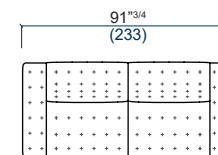

Tout élément central et angle panoramique sera nécessairement relié à 2 bâtarde, un de chaque côté de l'élément

Any central element or panoramic corner-unit must be attached to a 1-arm unit on both sides

Todo elemento central y ángulo panorámico tiene que estar unido a 2 batards, uno a cada lado del elemento

# SATELLITE 2

design Sacha LAKIC

## APPUIE-TETE RELEVABLE / ADJUSTABLE HEADREST / CABEZAL ELEVABLE 2/2



- 13** Bâtard 1 place accoudoir gauche  
1-seat 1-arm unit left armrest  
Batard 1 plaza apoyabrazo izquierdo

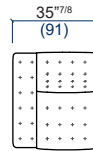

- 12** Bâtard 1 place accoudoir droit  
1-seat 1-arm unit right armrest  
Batard 1 plaza apoyabrazo derecho

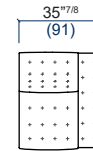

- 11** Elément central  
Central element  
Elemento central



- 15** Bâtard 1 place accoudoir gauche  
1-seat 1-arm unit left armrest  
Batard 1 plaza apoyabrazo izquierdo

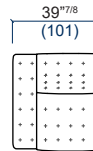

- 16** Bâtard 1 place accoudoir droit  
1-seat 1-arm unit right armrest  
Batard 1 plaza apoyabrazo derecho

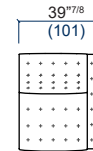

- 14** Elément central  
Central element  
Elemento central

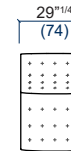

- 17** Bâtard 1 place accoudoir gauche  
1-seat 1-arm unit left armrest  
Batard 1 plaza apoyabrazo izquierdo

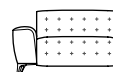
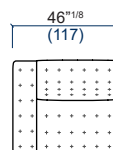

- 18** Bâtard 1 place accoudoir droit  
1-seat 1-arm unit right armrest  
Batard 1 plaza apoyabrazo derecho

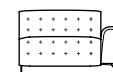
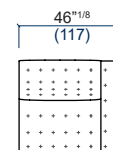

- 19** Elément central  
Central element  
Elemento central

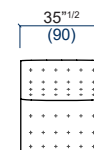

Tout élément central et angle panoramique sera nécessairement relié à 2 bâtards, un de chaque côté de l'élément

Any central element or panoramic corner-unit must be attached to a 1-arm unit on both sides

Todo elemento central y ángulo panorámico tiene que estar unido a 2 batards, uno a cada lado del elemento

# SATELLITE 2

design Sacha LAKIC

**50** Angle carré  
Square corner  
Angulo cuadrado

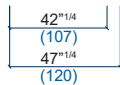
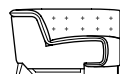
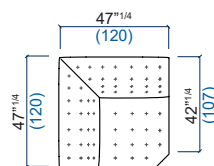

**51** Grand angle panoramique  
Large panoramic corner-unit  
Gran ángulo panorámico

