

# VOYAGE IMMOBILE 2

rochebobois  
PARIS

design Studio ROCHE BOBOIS



# VOYAGE IMMOBILE 2

design Studio ROCHE BOBOIS



**50** Angle carré  
Square corner  
Angulo cuadrado

**40** Pouf carré  
Square ottoman  
Puf cuadrado

**54** Chaise longue  
Lounge chair  
Chaise longue

**14** Chauffeuse  
Armless chair  
Chauffeuse

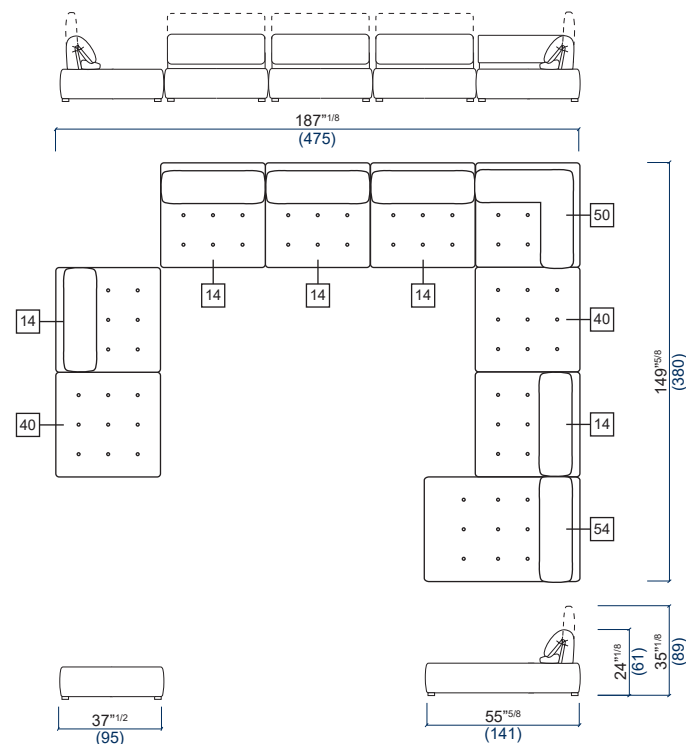

# VOYAGE IMMOBILE 2

design Studio ROCHE BOBOIS

rochebobois  
PARIS



# VOYAGE IMMOBILE 2

design Studio ROCHE BOBOIS

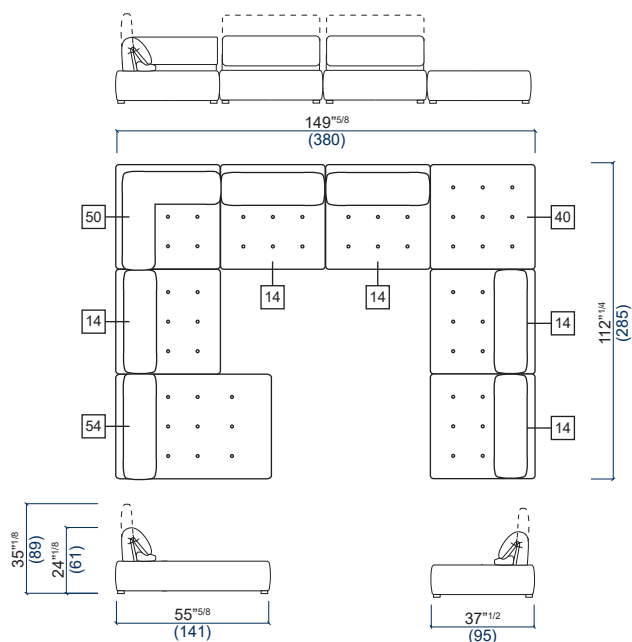

**50** Angle carré  
Square corner  
Angulo cuadrado

**40** Pouf carré  
Square ottoman  
Puf cuadrado

**54** Chaise longue  
Lounge chair  
Chaise longue

**14** Chauffeuse  
Armless chair  
Chauffeuse

# VOYAGE IMMOBILE 2

design Studio ROCHE BOBOIS

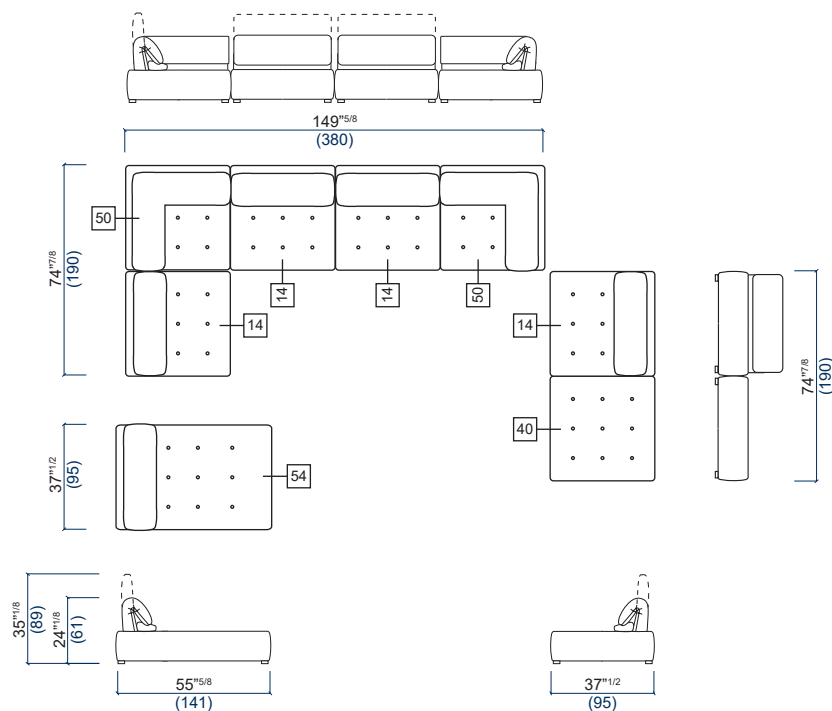

**50** Angle carré  
Square corner  
Angulo cuadrado

**40** Pouf carré  
Square ottoman  
Puf cuadrado

**54** Chaise longue  
Lounge chair  
Chaise longue

**14** Chauffeuse  
Armless chair  
Chauffeuse

# VOYAGE IMMOBILE 2

design Studio ROCHE BOBOIS



## FICHE TECHNIQUE / TECHNICAL SPECIFICATIONS / FICHA TECNICA:

Structure : Sapin massif, multiplis de pin et panneaux de particules

Suspension : Sangles élastiques HR

Garnissage assise : Mousse polyuréthane HR densité 35 kg/m<sup>3</sup> et fibre polyester

Garnissage dossier : Mousse polyuréthane HR densité 45 kg/m<sup>3</sup> et fibre polyester

Garnissage cale-reins : Plume d'oie

Piètement : Hêtre massif verni teinté wengé

Structure: Solid fir wood, pine plywood and engineered composite wood

Suspension: HR elastic straps

Seat cushion: HR polyurethane foam 35 kg/m<sup>3</sup> and polyester fibre

Back cushion: HR polyurethane foam 45 kg/m<sup>3</sup> and polyester fibre

Lumbar cushion: Goose feather

Base: Solid beech wood with varnish stain finish, col. wengé

Estructura: Abeto macizo, multilaminado de pino y paneles de partículas

Suspensión: Cinchas elásticas HR

Interior asiento: Espuma poliuretano HR densidad 35 kg/m<sup>3</sup> y fibra poliéster

Interior respaldo: Espuma poliuretano HR densidad 45 kg/m<sup>3</sup> y fibra poliéster

Interior riñonera: Pluma de oca

Patatas: Haya maciza barniz tintado wengué

## OBSERVATIONS / OBSERVATIONS / OBSERVACIONES :

- Fabrication Européenne
- Entièrement déshabillable
- Assise capitonnée
- Dossier relevable avec mécanisme à 4 pistons à gaz sur la Chauffeuse et la Chaise Longue.
- Dossier fixe sur l'Angle carré
- Modèle réalisable dans l'ensemble des tissus de la collection Roche Bobois, à l'exception des tissus Techno 2D, Techno 3D et Techno 4D
- Modèle non réalisable en cuir

- Manufactured in Europe
- Entirely removable covers
- Padded seat cushion
- Adjustable backs with a 4-pistons gas mechanism for the Armless Chair and the Lounge Chair.
- Fixed backrest on the square Corner
- This model is available in all fabrics from the Roche Bobois collection, with the exception of the Techno 2D, Techno 3D and Techno 4D fabrics
- This model is not available in leather

- Fabricación europea
- Completamente desenfundable
- Cojín de asiento capitoné
- Respaldo elevables con mecanismo de 4 pistones a gas en la Chauffeuse y en la Chaise Longue.
- Respaldo fijo en el Angulo cuadrado
- Modelo realizable en piel y en todas las telas de la colección Roche Bobois, excepto con las telas Techno 2D, Techno 3D y Techno 4D
- Modelo no realizable en piel

# VOYAGE IMMOBILE 2

design Studio ROCHE BOBOIS

**14** Chauffeuse  
Armless chair  
Chauffeuse

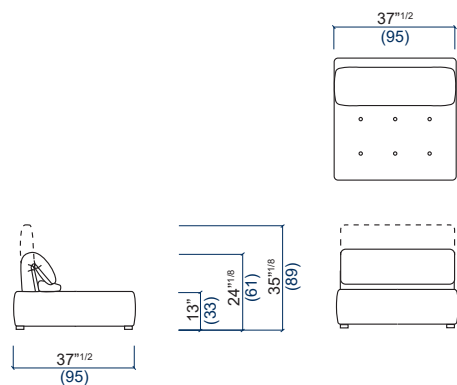

**40** Pouf carré  
Square ottoman  
Puf cuadrado

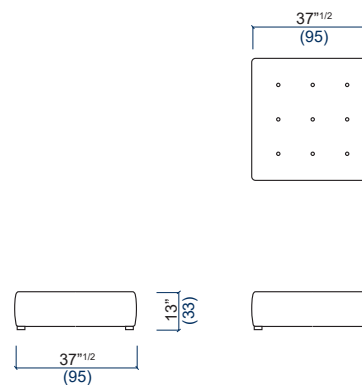

**99** Coussin carré  
Square cushion  
Cojín cuadrado

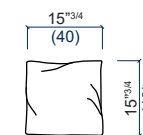

**54** Chaise longue  
Lounge chair  
Chaise longue

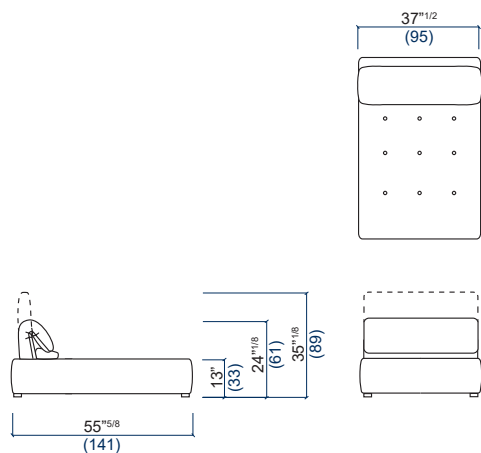

**50** Angle carré  
Square corner  
Angulo cuadrado

