

# SCENARIO

design Sacha LAKIC

rochebobois  
PARIS



# SCENARIO

design Sacha LAKIC

rochebobois  
PARIS



# SCENARIO

design Sacha LAKIC

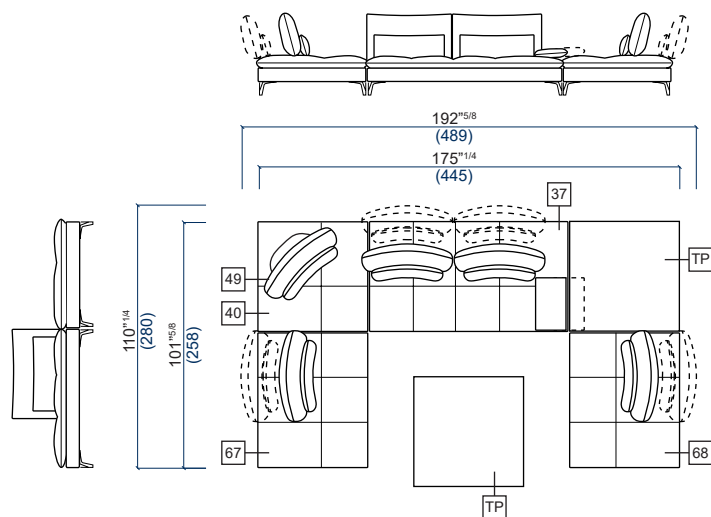

- 37** Bâtard 3 places droit  
3-seat 1-arm unit right armrest  
Batard 3 plazas derecha
- 67** Terminal gauche  
End unit - Left  
Terminal izquierda
- 68** Terminal droit  
End unit - right  
Terminal derecha

- 40** Pouf carré L.115  
Square ottoman L.115  
Puf cuadrado L.115
- 49** Dossier indépendant  
Independent backrest  
Respaldo independiente
- TP** Table carrée  
Square table  
Mesa cuadrada

# SCENARIO

design Sacha LAKIC

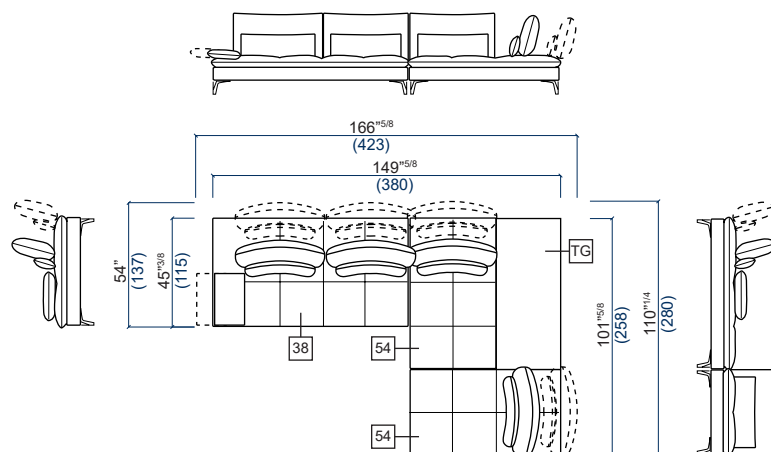

**38** Bâtard 3 places gauche  
3-seat 1-arm unit left armrest  
Batard 3 plazas izquierda

**54** Chaise longue  
Lounge chair  
Chaise longue

**TG** Table rectangulaire  
Rectangular table  
Mesa rectangular

# SCENARIO

design Sacha LAKIC



## FICHE TECHNIQUE / TECHNICAL SPECIFICATIONS / FICHA TECNICA:

Structure : Sapin massif, multiplis de pin et panneaux de particules

Suspension : Sangles élastiques HR

Garnissage assise : Mousse polyuréthane HR bi-densité 35-40 kg/m<sup>3</sup> et fibre polyester

Garnissage dossier : Mousse polyuréthane HR densité 21 kg/m<sup>3</sup> et fibre polyester

Garnissage accoudoir : Mousse polyuréthane HR densité 30 kg/m<sup>3</sup> et ouate de polyester

Garnissage cale-reins : Mousse polyuréthane HR densité 22 kg/m<sup>3</sup> et ouate de polyester

Piètement : Métal

Structure: Solid fir wood, pine plywood and engineered composite wood

Suspension: HR elastic straps

Seat cushion: HR bi-density polyurethane foam 35-40 kg/m<sup>3</sup> and polyester fibre

Back cushion: HR polyurethane foam 21 kg/m<sup>3</sup> and polyester fibre

Armrest cushion: HR polyurethane foam 30 kg/m<sup>3</sup> and polyester fibre

Lumbar cushion: HR polyurethane foam 22 kg/m<sup>3</sup> and polyester batting

Legs: Metal

Estructura: Abeto macizo, multilaminado de pino y paneles de partículas

Suspensión: Cinchas elásticas HR

Interior asiento: Espuma poliuretano HR bi-densidad 35-40 kg/m<sup>3</sup> y fibra poliéster

Interior respaldo: Espuma poliuretano HR densidad 21 kg/m<sup>3</sup> y fibra poliéster

Interior apoyabrazo: Espuma poliuretano HR densidad 30 kg/m<sup>3</sup> y guata poliéster

Interior riñonera: Espuma poliuretano HR densidad 22 kg/m<sup>3</sup> y guata poliéster

Patatas: Metal

## OBSERVATIONS / OBSERVATIONS / OBSERVACIONES:

- Fabrication Européenne
- Dossiers à double profondeur avec mécanisme à balancier; accoudoirs mécaniques avec ouverture latérale
- Assise capitonnée
- Modèle réalisable en cuir et dans l'ensemble des tissus de la collection Roche Bobois, à l'exception des tissus Techno 2D, Techno 3D, Techno 4D, à motifs ou à rayures (avec raccords) et des velours
- Manufactured in Europe
- Back cushions with double depth and with manual mechanism; manually adjustable armrests with side partition
- Padded seat cushions
- This model is available in leather and all fabrics from the Roche Bobois collection, with the exception of Techno 2D, Techno 3D and Techno 4D fabrics, striped and patterned fabrics (with repeat) and velvets
- Fabricación europea
- Respaldos de doble profundidad con mecanismo a balancín; apoyabrazos mecánicos con apertura lateral
- Cojín de asiento capitoné
- Modelo realizable en piel y en todas las telas de la colección Roche Bobois, excepto con las telas Techno 2D, Techno 3D, Techno 4D, las telas con motivos y rayadas (con racords) y los terciopelos

## OPTIONS / OPTIONAL / OPCIONES:

- Coutures anglaises blanches, contrastées ou ton sur ton, fil épais, disponibles uniquement dans la version cuir
- Piètement disponible en métal dans plusieurs finitions (Chromé brillant, Chromé satiné ou Nickel noir) et en acier inoxydable dans les finitions Chrome brillant ou Nickel noir
- Tables bois, MDF plaqué chêne disponibles dans plusieurs finitions : Wengé, Taupe, Souris, Gris ou Sable
- White, contrasting or tone-on-tone english stitching; thick thread, only available for leather version
- Legs are available in metal in many finishes (Glossy chrome-plated, Matte chrome-plated or Black nickel) and in stainless steel with a Glossy chrome-plated or Black nickel finish
- Wooden tables, MDF with oak veneer: many finishes available, Wenge, Taupe, Souris, Grey or Sable
- Costuras inglesas blancas, tono sobre tono o contrastadas, hilo grueso, disponibles solamente para la versión en piel
- Patas disponibles en metal en varios acabados (Cromado brillante, Cromado satinado o Níquel negro) y en acero inoxidable con acabado Cromo brillante o Níquel negro
- Mesas de madera, MDF chapado roble disponibles en varios acabados: Wengé, Taupe, Souris, Gris o Sable

# SCENARIO

design Sacha LAKIC

## FINITIONS PIETEMENT / LEG FINISH / ACABADO PATAS



Chromé Brillant  
Glossy Chrome-plated  
Cromado Brillante



Chrome Satiné  
Matte Chrome-plated  
Cromado Satinado



Nickel Noir  
Black Nickel  
Niquel Negro

design Sacha LAKIC

## TABLE FINITIONS BOIS / TABLE WOOD FINISH / MESA ACABADO MADERA



Teinte Wengé  
Wenge stain  
Tinte Wengé



Teinte Taupe  
Taupe stain  
Tinte Taupe



Teinte Souris  
Souris stain  
Tinte Souris



Teinte Grise  
Grey stain  
Tinte Gris



Teinte Sable  
Sable stain  
Tinte Sable



# SCENARIO

design Sacha LAKIC

**30** Canapé 3 places  
3 seater sofa  
Sofá 3 plazas

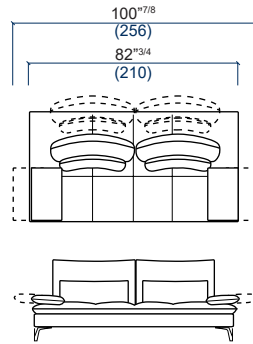

**35** Grand Canapé 3 places  
Large 3 seater sofa  
Gran Sofá 3 plazas

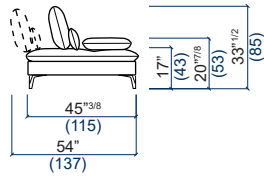
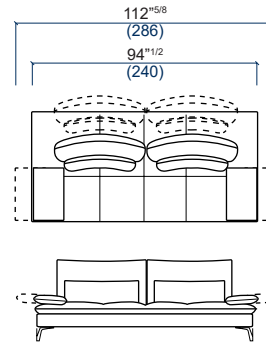

**13** Bâtarde 1 place gauche  
1-seat 1-arm unit left armrest  
Batard 1 plaza izquierdo

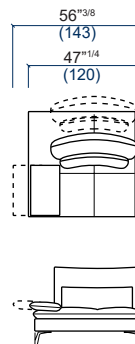

**12** Bâtarde 1 place droite  
1-seat 1-arm unit right armrest  
Batard 1 plaza derecho

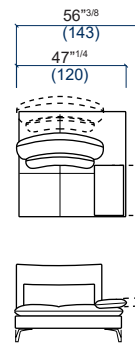

**38** Bâtarde 3 places gauche  
3-seat 1-arm unit left armrest  
Batard 3 plazas izquierda

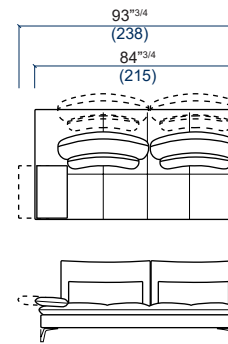

**37** Bâtarde 3 places droite  
3-seat 1-arm unit right armrest  
Batard 3 plazas derecha

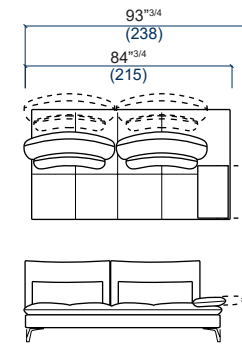



# SCENARIO

design Sacha LAKIC

**14** Chauffeuse  
1-seat armless  
Chauffeuse

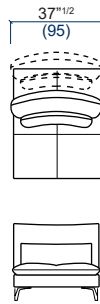
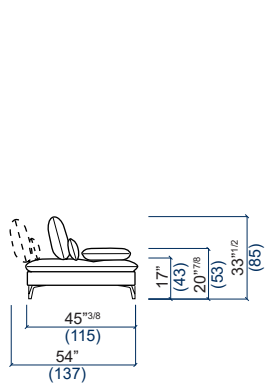

**29** Banquette 2.5 places  
2.5-seat armless sofa  
Banqueta 2.5 plazas

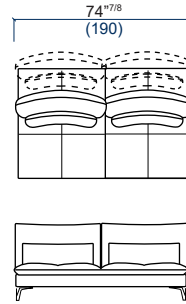

**67** Terminal gauche  
End unit - Left  
Terminal izquierda

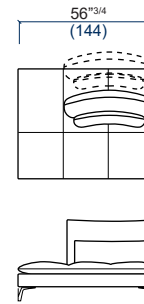

**68** Terminal droit  
End unit - right  
Terminal derecha

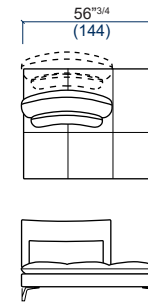

**54** Chaise longue  
Lounge chair  
Chaise longue

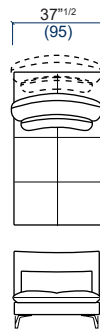
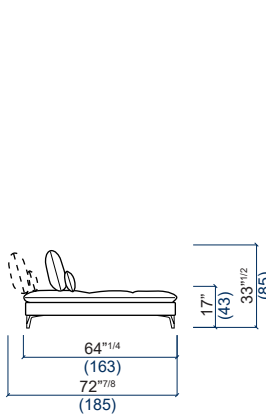

**50** Angle carré  
Square corner  
Ángulo cuadrado

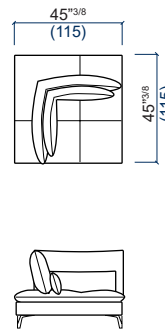

# SCENARIO

design Sacha LAKIC

**40** Pouf carré L.115  
Square ottoman L.115  
Puf cuadrado L.115

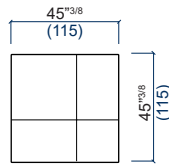

**41** Pouf carré L.95  
Square ottoman L.95  
Puf cuadrado L.95

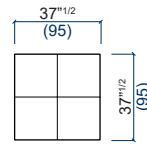

**49** Dossier indépendant  
Independent backrest  
Respaldo independiente

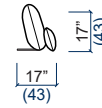
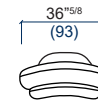

**TP** Table carrée  
Square table  
Mesa cuadrada

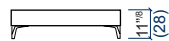
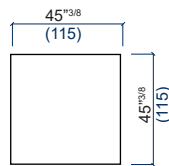

**TG** Table rectangulaire  
Rectangular table  
Mesa rectangular

