

ACCORD

design Sacha LAKIC

rochebobois
PARIS



ACCORD

design Sacha LAKIC

rochebobois
PARIS

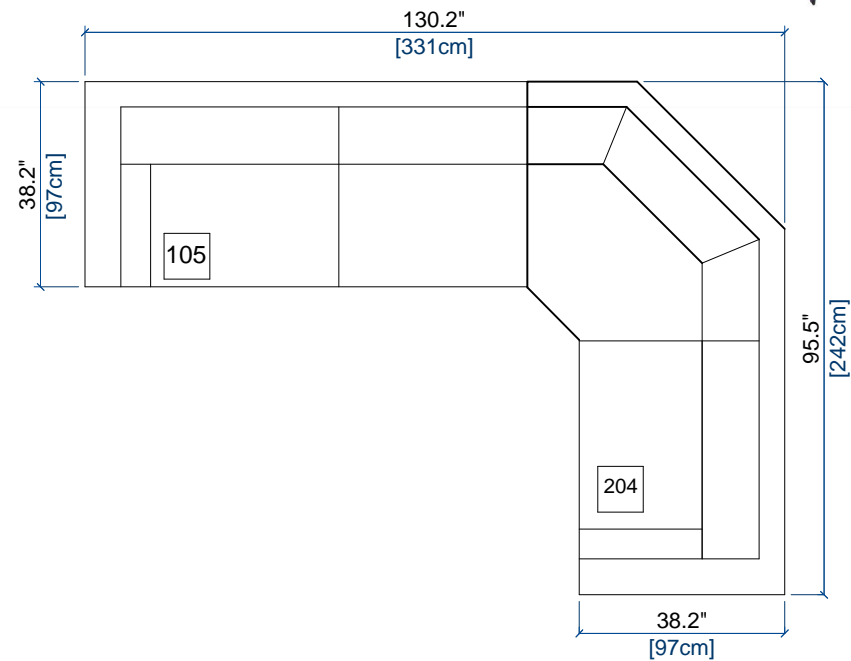

105 BATARD 3 PL ACC. GAUCHE / 3-SEAT 1-ARM UNIT LEFT ARMREST / BATARD 3 PL. APOY. IZQUIERDO

204 ANGLE MAXI PANORAMIQUE GAUCHE ACC. DROIT / MAXI LEFT PANORAMIC CORNER-RIGHT ARM / ANGULO MAXI PANORAMICO IZQUIERDO-APOY. DERECHO

ACCORD

design Sacha LAKIC

rochebobois
PARIS



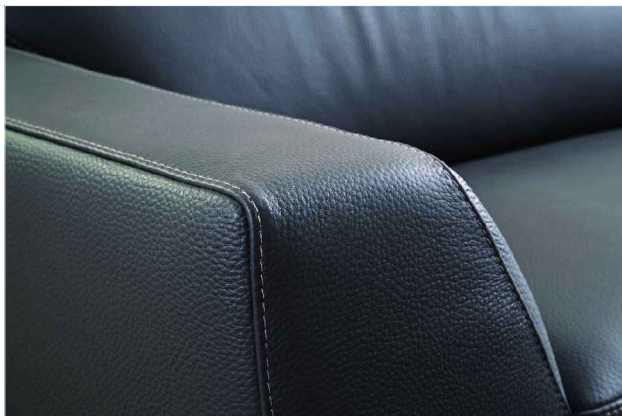

INFORMATIONS TECHNIQUES / TECHNICAL SPECIFICATIONS / FICHA TECNICA :

Structure : Sapin massifs et multiplis de pin
Suspension : Sangles élastiques XL entrecroisées
Garnissage assise monobloc : Mousse HR bi-densité 40-45 kg/m³
Garnissage dossier : Mousse 18S et ouate
Piétement : Fonte d'aluminium finition Nickel Noir

Structure: Solid fir wood and pine plywood
Suspension: XL cross-webbing elastic straps
Monobloc seat cushion: Bi-density HR foam 40-45 kg/m³
Back cushion: Foam 18S and polyester fibre
Base: Cast aluminium, black Nickel finish

Estructura: Abeto macizo y multilaminado de pino
Suspensión: Cinchas elásticas XL entrecruzadas
Interior asiento monobloc: Espuma HR bi-densidad 40-45 Kg/ m³
Interior respaldo: Espuma 18S y guata
Patas: Fundición de aluminio acabado níquel negro

OBSERVATIONS / OBSERVATIONS / OBSERVACIONES :

- Fabrication Européenne
- Modèle réalisable dans l'ensemble des revêtements de la collection ROCHE BOBOIS à l'exception des cuirs d'épaisseur supérieure à 2,8 mm
- Certains éléments peuvent être utilisés indépendamment les uns des autres ; par conséquent, ils sont entièrement recouverts de cuir ou de tissu

- Manufactured in Europe
- Model available in all exclusive materials from the ROCHE BOBOIS collection, with the exception of leathers with thickness of more than 2.8 mm
- The independent elements can be used separately from each other; therefore, they must be entirely upholstered in leather or fabric

- Fabricación europea
- Modelo realizable en todas las telas y pieles de la colección ROCHE BOBOIS excepto con pieles de un grosor superior a 2,8 mm
- Algunos elementos pueden ser utilizados independientemente por estar completamente tapizados de piel o tela

OPTIONS / OPTIONAL / OPCIONES :

- Confort normal ou ferme
- Coutures contrastées ou ton sur ton
- Piétement : Fonte d'aluminium finition teinté wengé ou Métal teinté Gris
- Tête

- Standard or firm comfort
- Contrasting or tone-on tone stitching
- Base: Cast aluminium with a stain finish, col. Wenge, or metal with a stain finish, col. dark grey.
- Headrest

- Confort normal o firme
- Costuras contrastadas o tono sobre tono
- Patas: Fundición de aluminio acabado wengue o metal tintado gris oscuro
- Cabezal

GRAND CANAPE 3 PLACES
LARGE 3-SEAT SOFA
GRAN SOFA 3 PLAZAS

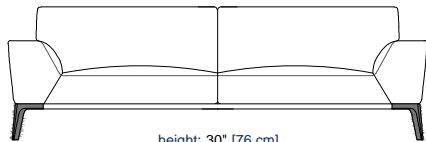
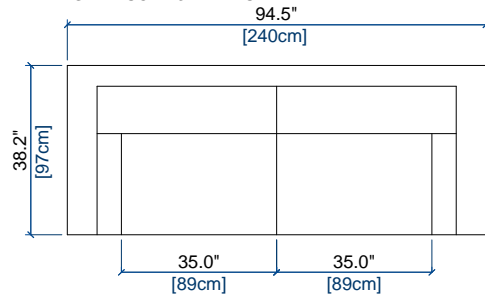

height: 30" [76 cm]
seat height: 16.6" [42 cm]
arm width : 12.2" [31 cm]

CANAPE 3 PLACES
3-SEAT SOFA
SOFA 3 PLAZAS

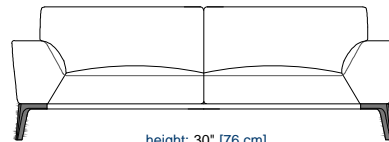
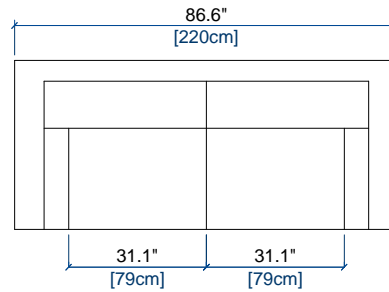

height: 30" [76 cm]
seat height: 16.6" [42 cm]
arm width : 12.2" [31 cm]

CANAPE 2,5 PLACES
2.5-SEAT SOFA
SOFA 2,5 PLAZAS

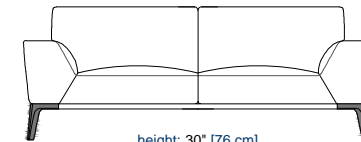
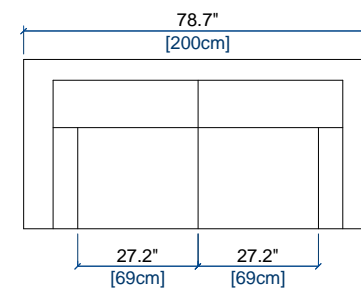

height: 30" [76 cm]
seat height: 16.6" [42 cm]
arm width : 12.2" [31 cm]

CANAPE 2 PLACES
2-SEAT SOFA
SOFA 2 PLAZAS

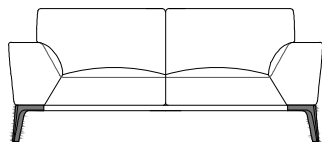
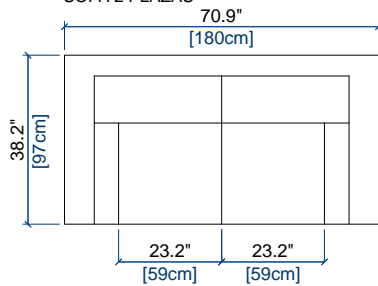

height: 30" [76 cm]
seat height: 16.6" [42 cm]
arm width : 12.2" [31 cm]

FAUTEUIL
ARMCHAIR
SILLON

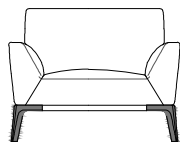
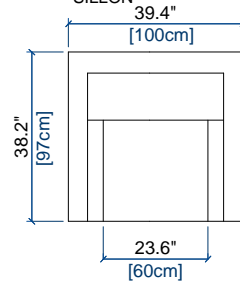

height: 30" [76 cm]
seat height: 16.6" [42 cm]
arm width : 12.2" [31 cm]

POUF CARRE
SQUARE OTTOMAN
PUF QUADRADO

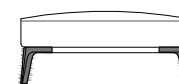
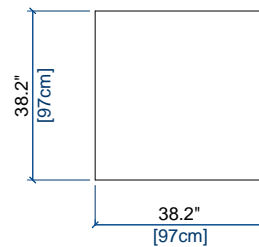

seat height: 16.6" [42 cm]

TETIERE
HEADREST
CABEZAL

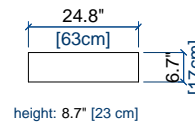

height: 8.7" [23 cm]

TETIERE POUR FAUTEUIL
HEADREST FOR ARMCHAIR
CABEZAL PARA SILLON

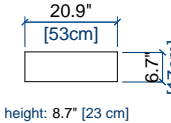

height: 8.7" [23 cm]

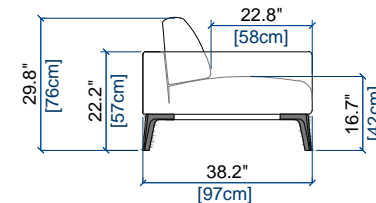

105 BATARD 3 PL. ACC. GAUCHE
3-SEAT 1-ARM UNIT LEFT ARMREST
BATARD 3 PL. APOY. IZQUIERDO

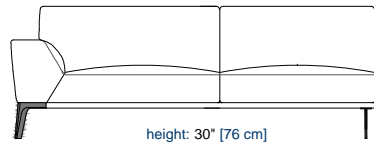
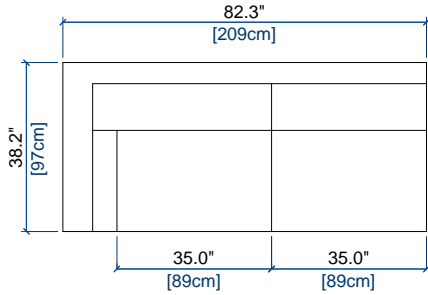

height: 30" [76 cm]
seat height: 16.6" [42 cm]
arm width: 12.2" [31 cm]

106 BATARD 3 PL. ACC. DROIT
3-SEAT 1-ARM UNIT RIGHT ARMREST
BATARD 3 PL. APOY. DERECHO

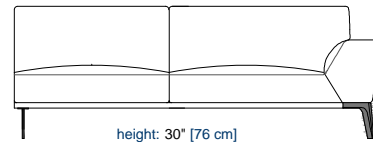
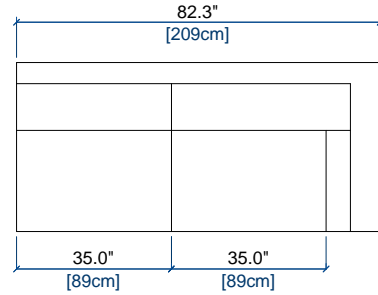

height: 30" [76 cm]
seat height: 16.6" [42 cm]
arm width: 12.2" [31 cm]

63 BATARD 2,5 PL. ACC. GAUCHE
2.5-SEAT 1-ARM UNIT LEFT ARMREST
BATARD 2,5 PL. APOY. IZQUIERDO

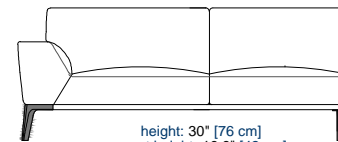
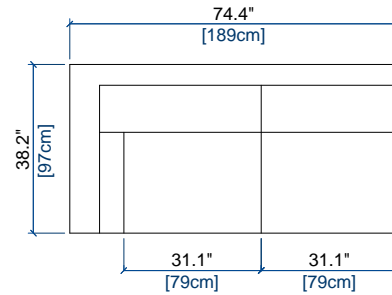

height: 30" [76 cm]
seat height: 16.6" [42 cm]
arm width: 12.2" [31 cm]

62 BATARD 2,5 PL. ACC. DROIT
2.5-SEAT 1-ARM UNIT RIGHT ARMREST
BATARD 2,5 PL. APOY. DERECHO

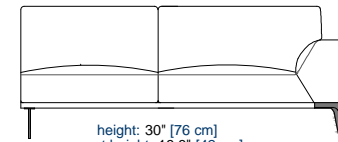
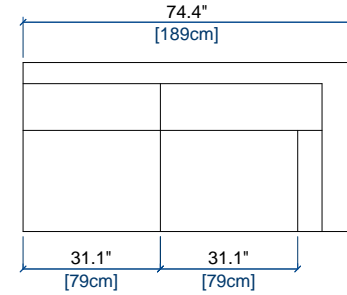

height: 30" [76 cm]
seat height: 16.6" [42 cm]
arm width: 12.2" [31 cm]

27 BATARD 2 PL. ACC. GAUCHE
2-SEAT 1-ARM UNIT LEFT ARMREST
BATARD 2 PL. APOY. IZQUIERDO

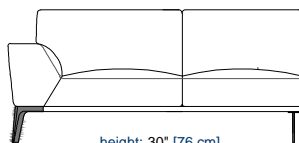
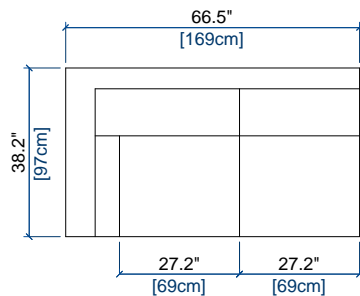

height: 30" [76 cm]
seat height: 16.6" [42 cm]
arm width: 12.2" [31 cm]

26 BATARD 2 PL. ACC. DROIT
2-SEAT 1-ARM UNIT RIGHT ARMREST
BATARD 2 PL. APOY. DERECHO

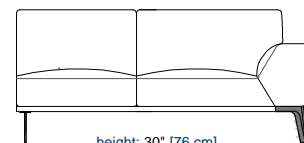
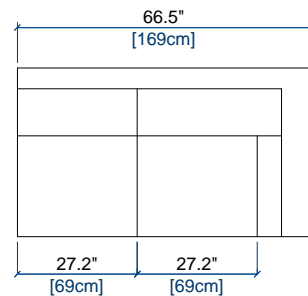

height: 30" [76 cm]
seat height: 16.6" [42 cm]
arm width: 12.2" [31 cm]

29 BATARD 1 PL. ACC. GAUCHE
1-SEAT 1-ARM UNIT LEFT ARMREST
BATARD 1 PL. APOY. IZQUIERDO

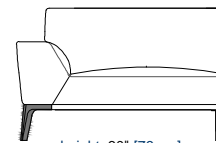
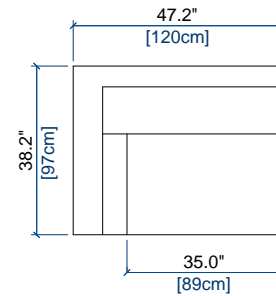

height: 30" [76 cm]
seat height: 16.6" [42 cm]
arm width: 12.2" [31 cm]

28 BATARD 1 PL. ACC. DROIT
1-SEAT 1-ARM UNIT RIGHT ARMREST
BATARD 1 PL. APOY. DERECHO

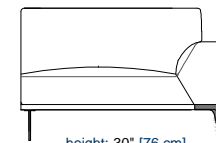
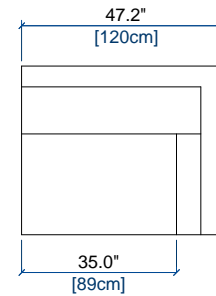

height: 30" [76 cm]
seat height: 16.6" [42 cm]
arm width: 12.2" [31 cm]

8P ANGLE/MERIDIENNE GAUCHE
CORNER/MERIDIENNE LEFT
ANGULO/MERIDIENNE IZQUIERDA

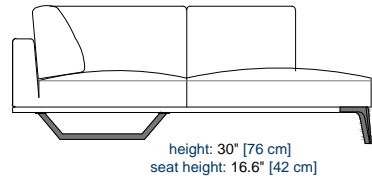
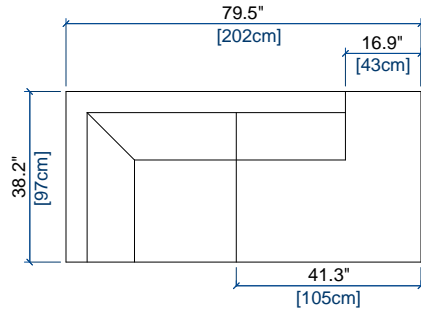

9P ANGLE/MERIDIENNE DROITE
CORNER/MERIDIENNE RIGHT
ANGULO/MERIDIENNE DERECHA

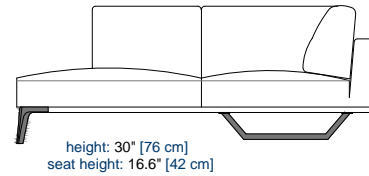
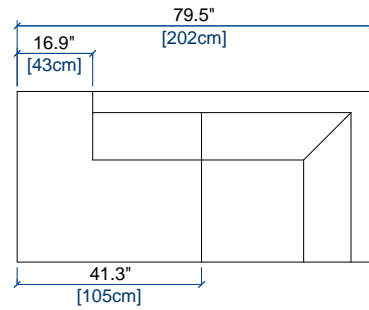

08 GRAND ANGLE/MERIDIENNE GAUCHE
LARGE CORNER/MERIDIENNE LEFT
GRAN ANGULO/MERIDIENNE IZQUIERDA

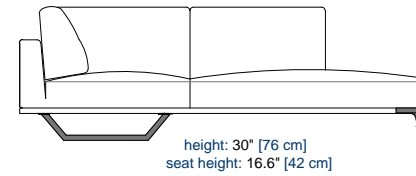
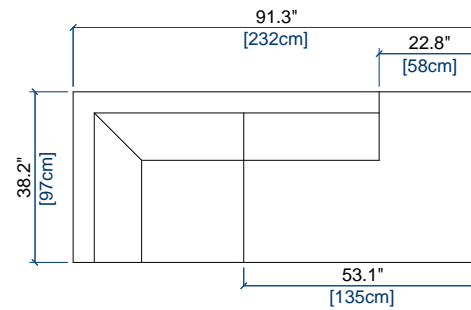

09 GRAND ANGLE/MERIDIENNE DROITE
LARGE CORNER/MERIDIENNE RIGHT
GRAN ANGULO/MERIDIENNE DERECHA

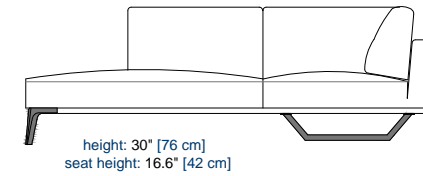
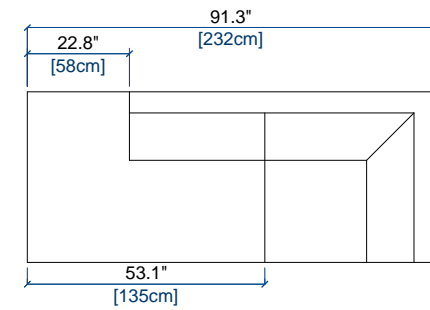

203 ANGLE MAXI PANORAMIQUE DROIT ACC. GAUCHE
MAXI RIGHT PANORAMIC CORNER-LEFT ARM
ANGULO MAXI PANORAMICO DERECHO-APOY. IZQUIERDO

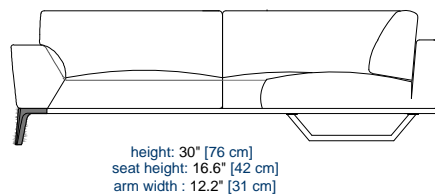
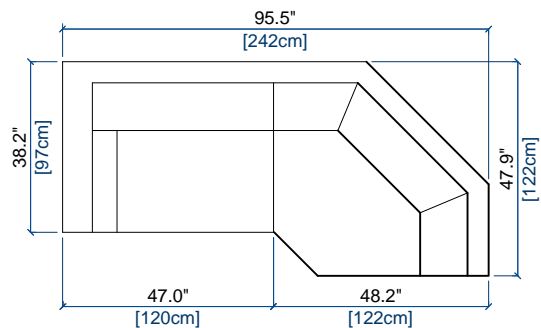

204 ANGLE MAXI PANORAMIQUE GAUCHE ACC. DROIT
MAXI LEFT PANORAMIC CORNER-RIGHT ARM
ANGULO MAXI PANORAMICO IZQUIERDO-APOY. DERECHO

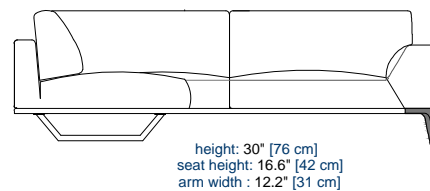
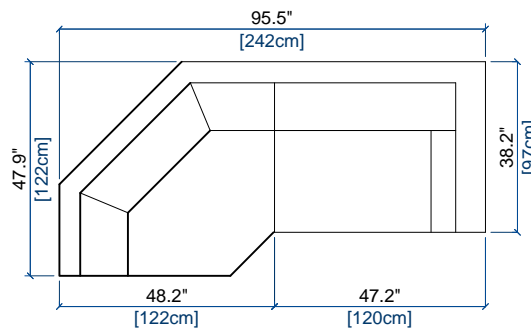

02 ANGLE CARRE
SQUARE CORNER
ANGULO CUADRADO

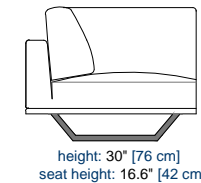
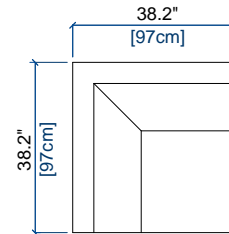

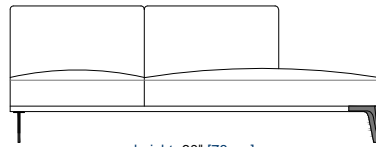
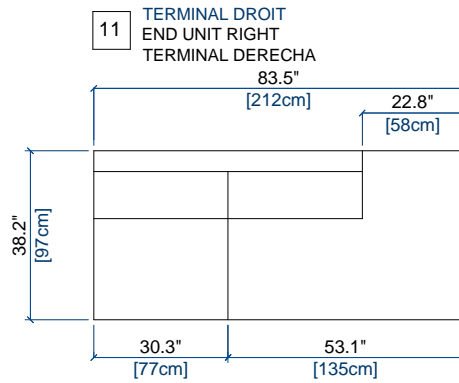

height: 30" [76 cm]
seat height: 16.6" [42 cm]

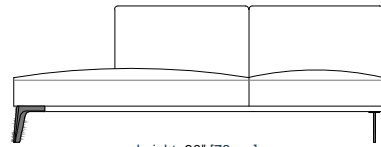
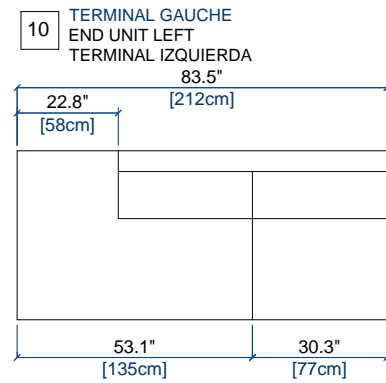

height: 30" [76 cm]
seat height: 16.6" [42 cm]

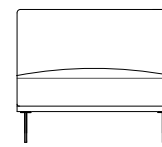
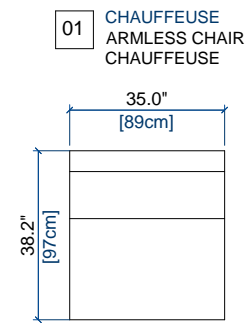

height: 30" [76 cm]
seat height: 16.6" [42 cm]

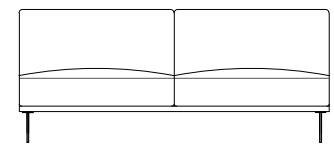
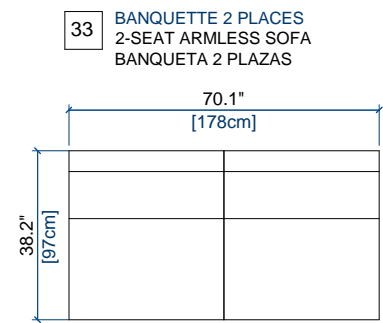

height: 30" [76 cm]
seat height: 16.6" [42 cm]

ÉLÉMENTS INDEPENDANTS / INDEPENDENT ELEMENTS / ELEMENTOS INDEPENDIENTES* 1/3

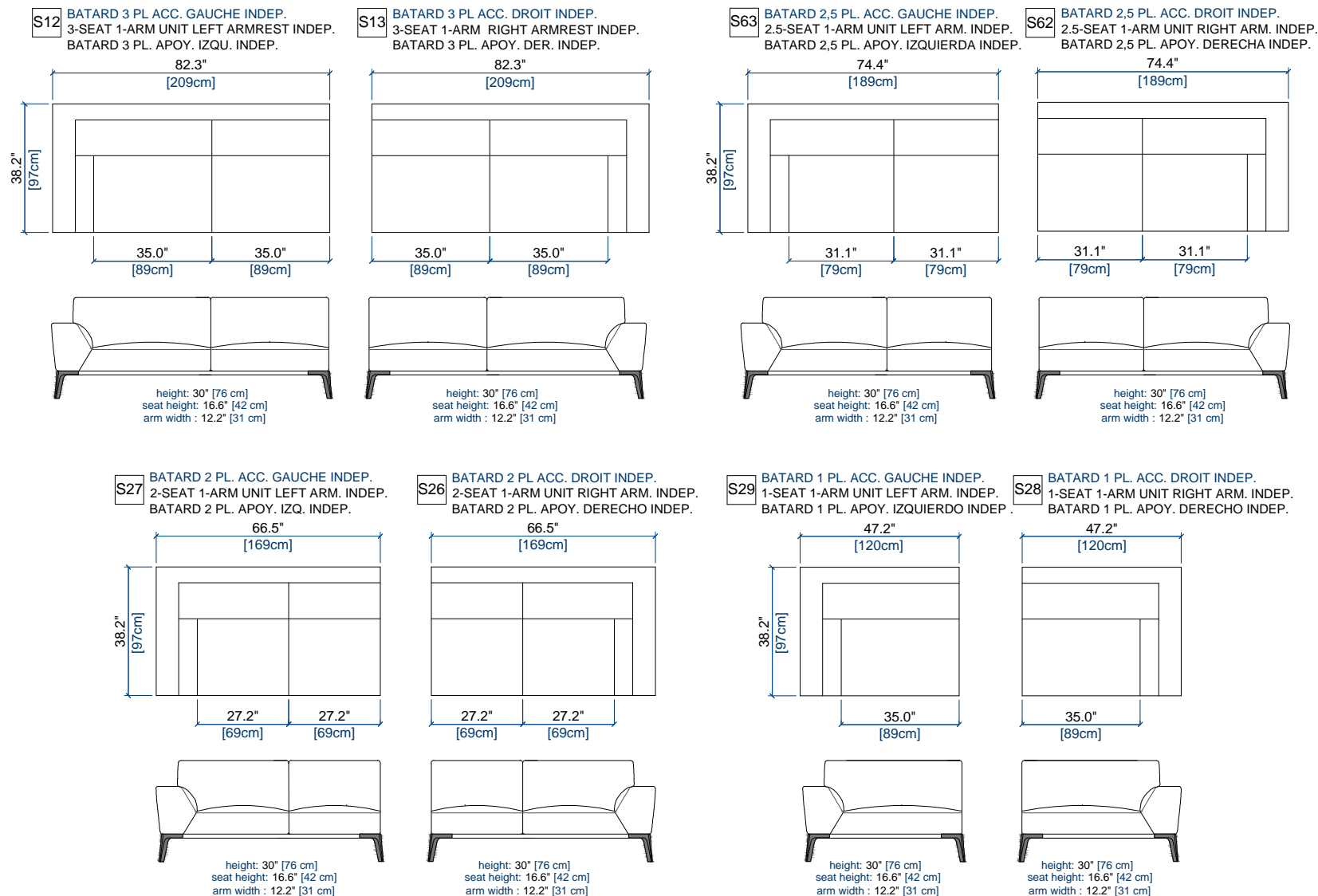

* Entièrement habillés de cuir ou de tissu / Entirely upholstered in leather or fabric / Completamente tapizados de piel o tela

ÉLÉMENTS INDEPENDANTS / INDEPENDENT ELEMENTS / ELEMENTOS INDEPENDIENTES* 2/3

S01 CHAUFFEUSE INDEP.
INDEP. ARMLESS CHAIR
CHAUFFEUSE INDEP.

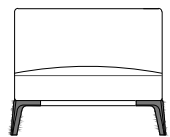
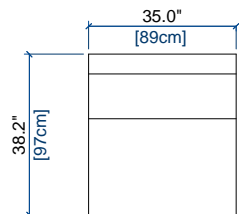

height: 30" [76 cm]
seat height: 16.6" [42 cm]

S1S CHAUFFEUSE INDEP. - GAUCHE
INDEP. ARMLESS CHAIR - LEFT
CHAUFFEUSE INDEP. - IZQU.

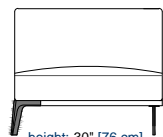
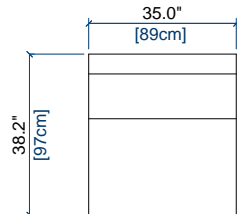

height: 30" [76 cm]
seat height: 16.6" [42 cm]

S1D CHAUFFEUSE INDEP. - DROITE
INDEP. ARMLESS CHAIR - RIGHT
CHAUFFEUSE INDEP. - DER.

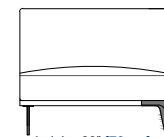
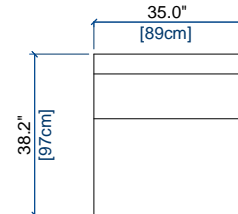

height: 30" [76 cm]
seat height: 16.6" [42 cm]

S33 BANQUETTE 2 PLACES INDEP.
2 INDEP. SEAT ARMLESS SOFA
BANQUETA 2 PLAZAS INDEP.

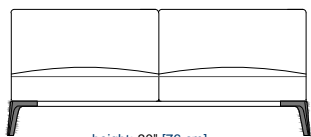
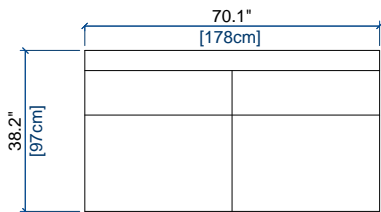

height: 30" [76 cm]
seat height: 16.6" [42 cm]

S34 BANQUETTE 2 PLACES INDEP. GAUCHE
2 INDEP. SEAT ARMLESS SOFA LEFT
BANQUETA 2 PLAZAS IZQ. INDEP.

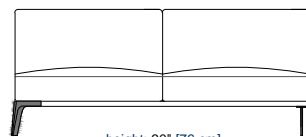
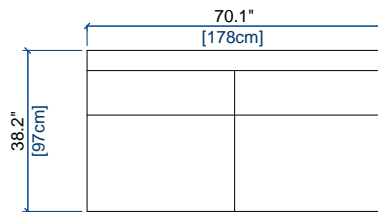

height: 30" [76 cm]
seat height: 16.6" [42 cm]

S35 BANQUETTE 2 PLACES INDEP. DROITE
2 INDEP. SEAT ARMLESS SOFA RIGHT
BANQUETA 2 PLAZAS DER. INDEP.

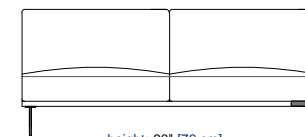
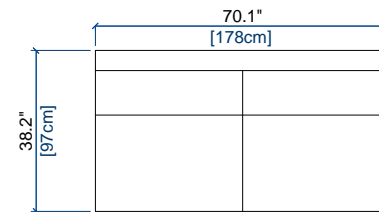

height: 30" [76 cm]
seat height: 16.6" [42 cm]

* Entièrement habillés de cuir ou de tissu / Entirely upholstered in leather or fabric / Completamente tapizados de piel o tela

ÉLÉMENTS INDEPENDANTS / INDEPENDENT ELEMENTS / ELEMENTOS INDEPENDIENTES* 3/3

S08 GRAND ANGLE/MERID. GAUCHE
INDEP.LARGE CORNER/MERID. LEFT
INDEP.GRAN ANGULO/MERID. IZQU. INDEP.

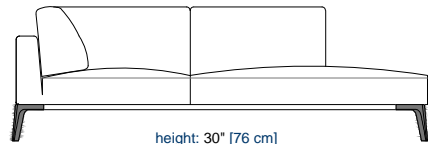
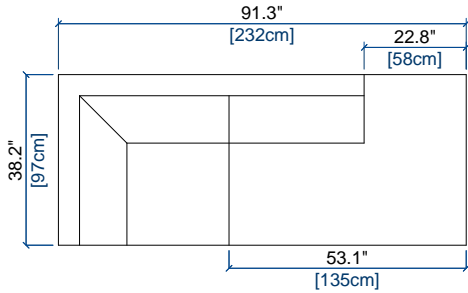

height: 30" [76 cm]
seat height: 16.6" [42 cm]

S09 GRAND ANGLE/MERID. DROITE INDEP.
LARGE CORNER/MERID. RIGHT INDEP.
GRAN ANGULO/MERID. DER. INDEP.

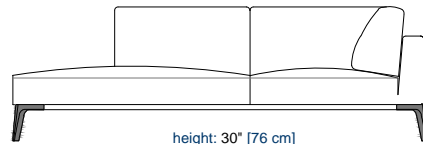
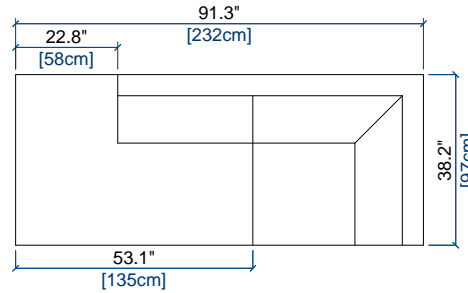

height: 30" [76 cm]
seat height: 16.6" [42 cm]

S8P ANGLE/MERIDIENNE GAUCHE INDEP.
CORNER/MERIDIENNE LEFT INDEP.
ANGULO/MERIDIENNE IZQUIERDA INDEP.

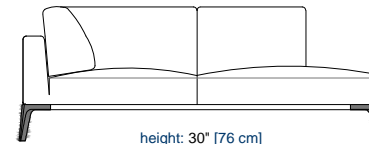
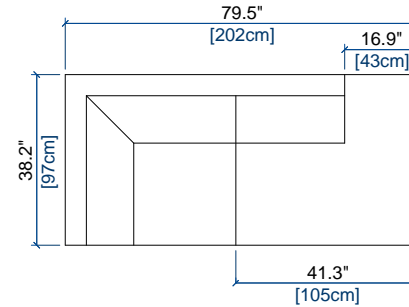

height: 30" [76 cm]
seat height: 16.6" [42 cm]

S9P ANGLE/MERIDIENNE DROITE INDEP.
CORNER/MERIDIENNE RIGHT INDEP.
ANGULO/MERIDIENNE DERECHA INDEP.

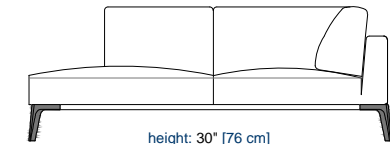
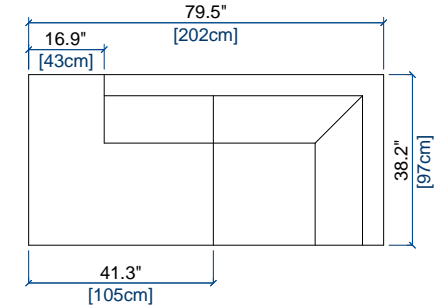

height: 30" [76 cm]
seat height: 16.6" [42 cm]

S11 TERMINAL DROIT INDEP.
END UNIT RIGHT INDEP.
TERMINAL DERECHO INDEP.

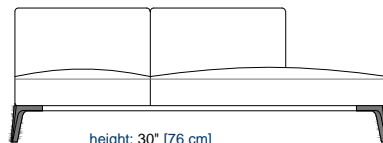
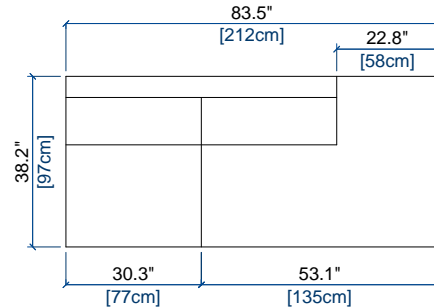

height: 30" [76 cm]
seat height: 16.6" [42 cm]

S10 TERMINAL GAUCHE INDEP.
END UNIT LEFT INDEP.
TERMINAL IZQUIERDO INDEP.

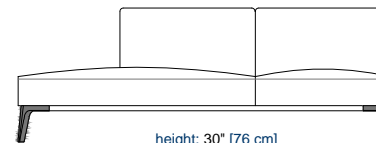
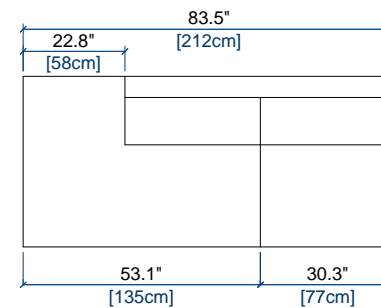

height: 30" [76 cm]
seat height: 16.6" [42 cm]

* Entièrement habillés de cuir ou de tissu / Entirely upholstered in leather or fabric / Completamente tapizados de piel o tela