

GLOBE TROTTER - MONTGOLFIERE

rochebobois
PARIS

design Marcel WANDERS



GLOBE TROTTER - MONTGOLFIERE

rochebobois
PARIS

design Marcel WANDERS



GLOBE TROTTER - MONTGOLFIERE

design Marcel WANDERS



INFORMATIONS TECHNIQUES / TECHNICAL SPECIFICATIONS / CARACTERISTICAS TECNICAS:

Structure : Métal, sapin massif et multiplis de pin
Suspension : Mailles soudées
Garnissage dossier : Mousse bi-densité 30-75 kg/m³ et fibres polyester 200 g/m²
Garnissage assise : Mousse bi-densité 40-30 kg/m³, fibres polyester 200 g/m² et vellutino
Garnissage accoudoir : Mousse bi-densité 30-75 kg/m³ et fibres polyester 200 g/m²
Piétements : Métal finition Bronze

Structure: Metal, solid firwood and pine plywood.

Suspension: Welded mesh

Back cushions: Bi-density foam 30-75 kg/m³ and polyester fibres 200 g/m²

Seat cushion: Bi-density foam 40-30 kg/m³, polyester fibres 200 g/m² and vellutino

Armrest cushion: Bi-density foam 30-75 kg/m³ and polyester fibres 200 g/m²

Base: Metal with bronze finish

Estructura: Metal, abeto macizo y multilaminado de pino

Suspensión: Mallas soldadas

Interior respaldo: Espuma bi-densidad 30-75 kg/m³ y fibras poliéster 200 g/m²

Interior asiento: Espuma de bi-densidad 40-30 kg/m³, fibras poliéster 200 g/m² y vellutino

Apoyabrazos: Espuma bi-densidad 30-75 kg / m³ y fibra de poliéster 200 g/m²

Patas: Metal acabado bronce

OBSERVATIONS / OBSERVATIONS / OBSERVACIONES:

- Fabrication Européenne
- Modèle réalisable dans tous les tissus de la collection ROCHE BOBOIS, à l'exception des tissus durs rigides comme les microribres

- Manufactured in Europe

- Tissue réalisable dans tous les tissus de la collection ROCHE BOBOIS, à l'exception des tissus durs rigides comme les microribres

- Fabricación europea

- Modelo realizabile en todos los tejidos de la colección ROCHE BOBOIS, a excepción de los tejidos duros rígidos como los microribres

GLOBE TROTTER - MONTGOLFIERE

design Marcel WANDERS

TISSUS COLLECTION GLOBE TROTTER GLOBE TROTTER COLLECTION OF FABRICS TELAS COLECCION GLOBE TROTTER

LES MOTIFS / THE PATTERNS / LOS MOTIVOS

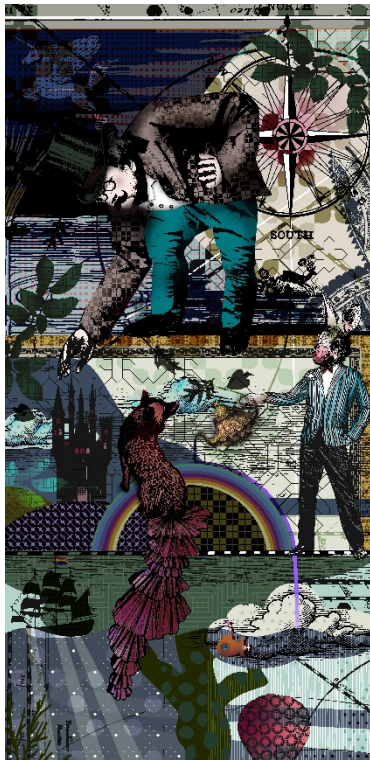

LONDRES



PARIS



ISTANBUL

GLOBE TROTTER - MONTGOLFIERE

design Marcel WANDERS

LES FAUX-UNIS



AZTEK Bronze

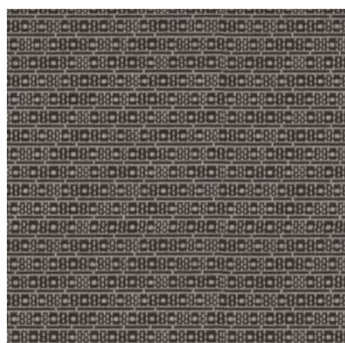

AZTEK Argent

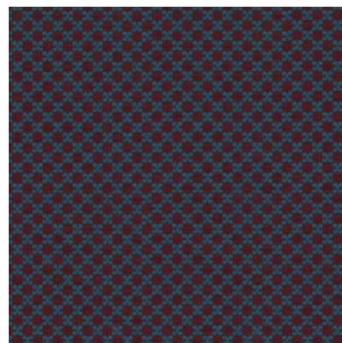

BLOSSOM Bleu

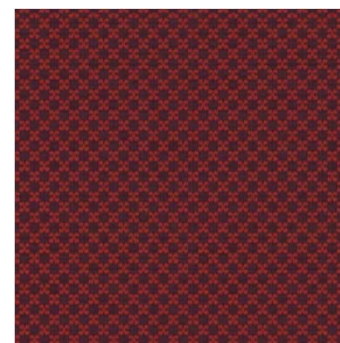

BLOSSOM Rouge



EILEEN Prune

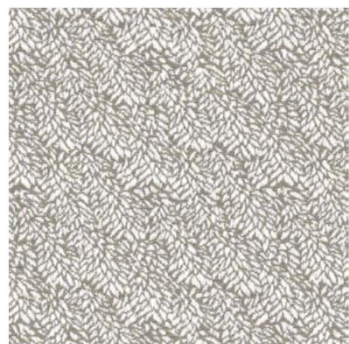

FOX Mastic

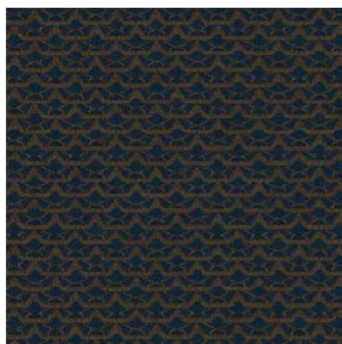

ORIGAMI Bleu

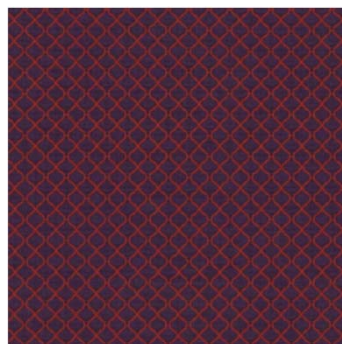

SONAR Rouge

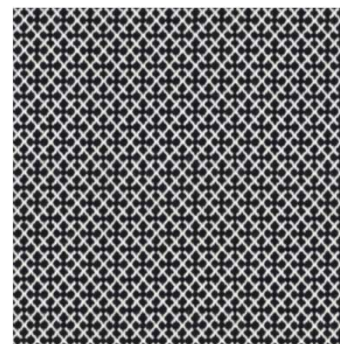

STITCH Noir & Blanc

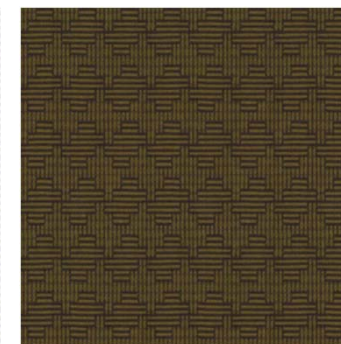

PARQUET Gold

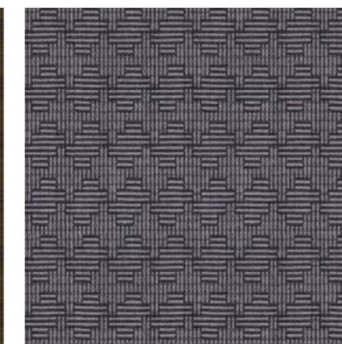

PARQUET Gris

GLOBE TROTTER - MONTGOLFIERE

design Marcel WANDERS

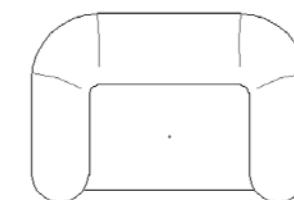
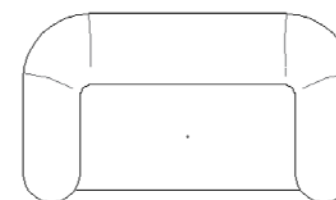
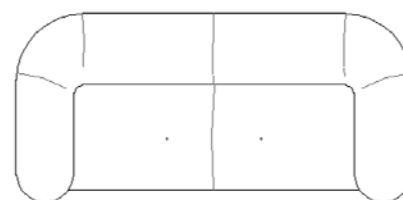
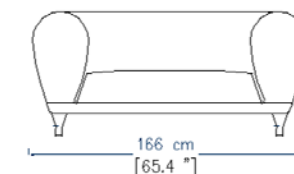
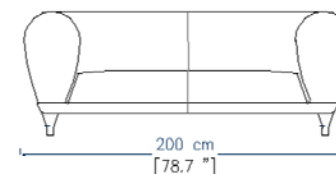
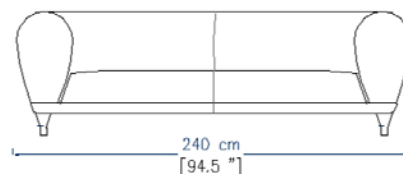
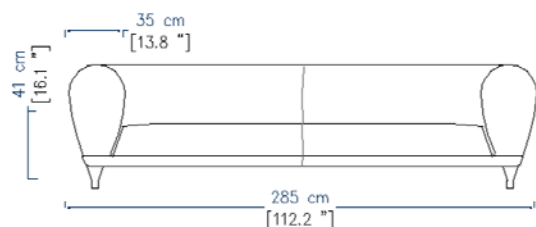
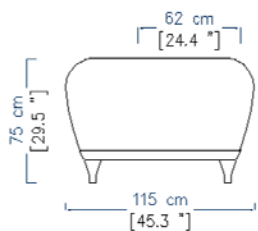

CANAPE 4 PLACES
4-SEAT SOFA
SOFA 4 PLAZAS

GRAND CANAPE 3 PLACES
LARGE 3-SEAT SOFA
GRAN SOFA 3 PLAZAS

CANAPE 2,5 PLACES
2,5-SEAT SOFA
SOFA 2,5 PLAZAS

CANAPE 2 PLACES (LOVE SEAT)
2-SEAT SOFA (LOVE SEAT)
SOFA 2 PLAZAS (LOVE SEAT)

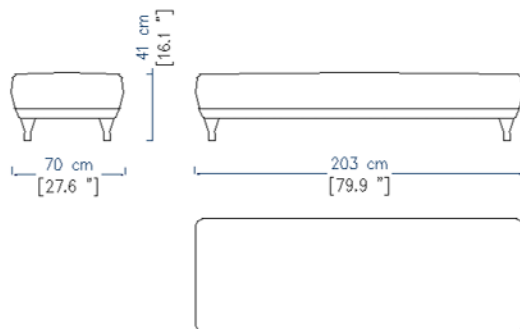

POUF RECTANGULAIRE
RECTANGULAR OTTOMAN
PUF RECTANGULAR

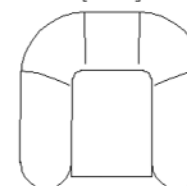
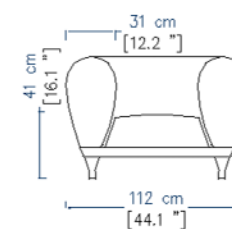
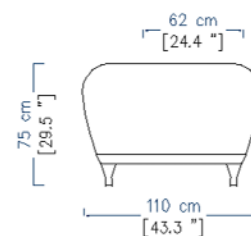

FAUTEUIL
ARMCHAIR
SILLON