

## SC16 2016



### Sistema di contenitori

#### Materiali:

**CONTENITORE:** pannelli di listellare impiallacciati in Abonos oak o rovere affumicato, finiti con vernice trasparente a base acqua o a base solvente. Bordo a 45° in legno massello di Abonos oak o rovere affumicato.

**CASSETTI:** listellare impiallacciato in Abonos oak o rovere affumicato, finiti con vernice trasparente a base acqua o a base solvente, montati su guide ad estrazione totale con meccanismo di ammortizzazione.

**FRONTALI CASSETTI:** listellare impiallacciato in Abonos oak o rovere affumicato, finiti con vernice trasparente a base acqua o a base solvente. Oppure in lamiera in ottone striato, acciaio striato grigio o acciaio délabré scuro. Bordo a 45° e maniglia in massello di essenza.

**PIANO:** listellare impiallacciato con Abonos oak o rovere affumicato, finiti con vernice trasparente a base acqua o a base solvente. Oppure pannello interno in alluminio strutturale rivestito con lamiera in ottone striato, acciaio striato grigio o acciaio délabré scuro. Oppure marmo Grey Stone o bianco Carrara o Calacatta Oro, finito a mano e trattato con prodotti idrorepellenti. Rinforzo inferiore con rete di fibra di vetro annegata con resine epossidiche.

**BASE:** acciaio verniciato a polvere nero opaco e piede in acciaio brunito. Sottopiede regolabile in termoplastica.

**PIEDINI:** acciaio brunito. Sottopiede regolabile in termoplastica.

+info:  
<http://www.depadova.com/materials.pdf>

Contenitori con piedini.

M75

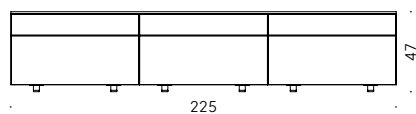
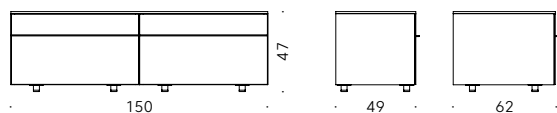

M90

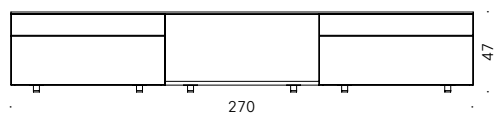
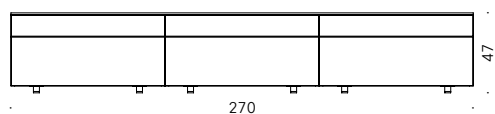
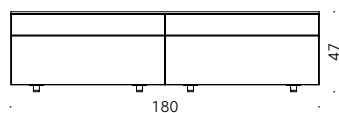

M120

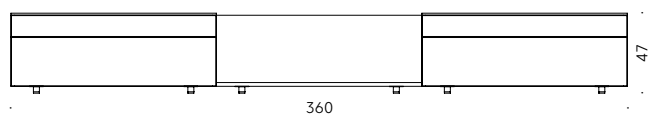
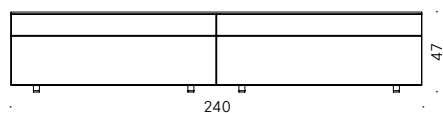
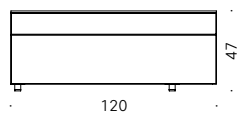

Contenitori con base.

M75

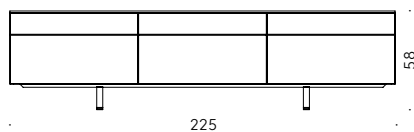
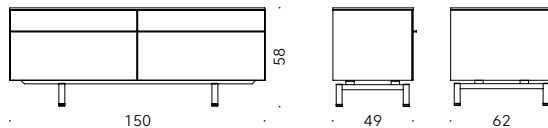

M90

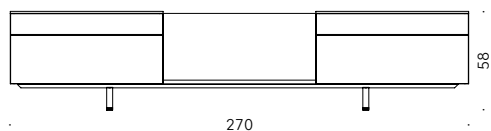
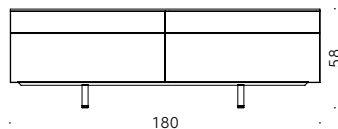

M120

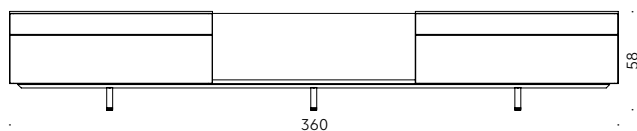
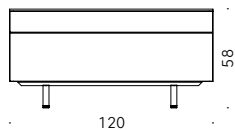

## SC16 2016



### Storage system

#### Materials:

CARCASS: blockboard panels veneered in Abonos Oak or smoked oak, finished with transparent water-based or solvent-based paint. 45° edges in solid wood (Abonos Oak or smoked oak).

DRAWERS: blockboard veneered in Abonos Oak or smoked oak, finished with transparent water-based or solvent-based paint. Installed on runners with soft-close system.

DRAWER FRONT PANELS: blockboard veneered in Abonos Oak or smoked oak, finished with transparent water-based or solvent-based paint. Or in striped brass, striped grey steel or dark délabré steel sheet. 45° edges and handles in solid wood (Abonos Oak or smoked oak).

TOP: blockboard veneered in Abonos Oak, smoked oak, finished with transparent water-based or solvent-based paint. Or internal panel in structural aluminum, coated with sheet in striped brass, grey striped steel or dark délabré steel. Or in Grey Stone or white Carrara or Calacatta Gold marble, finished by hand and treated with water-repellent products. Lower reinforcement with fiberglass mesh embedded in epoxy resins.

BASE: powder coated steel, matt black coloured, and feet in burnished steel. Adjustable thermoplastic glide foot.

FEET: burnished steel. Adjustable thermoplastic glide foot.

+info:

<http://www.depadova.com/materials.pdf>

Cabinets with feet.

M75

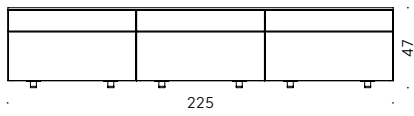
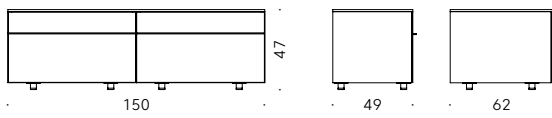

M90

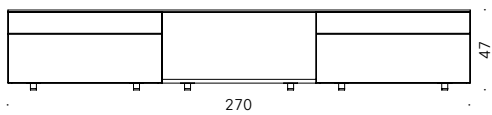
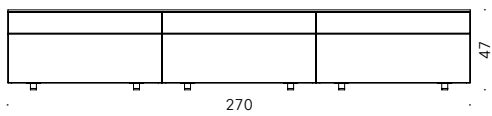
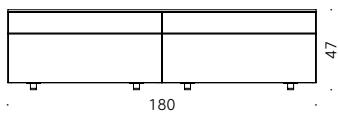

M120

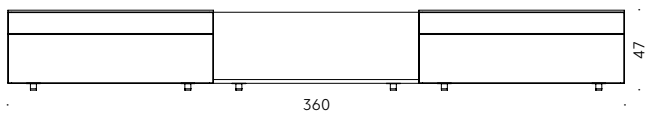
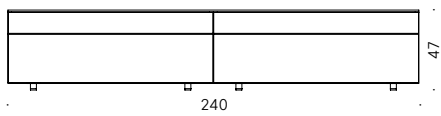
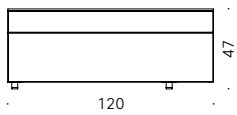

Cabinets with base.

M75

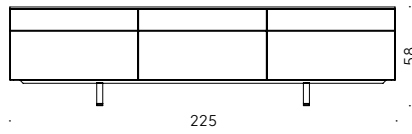
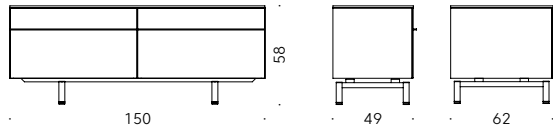

M90

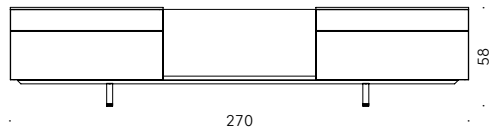
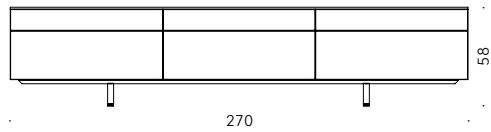
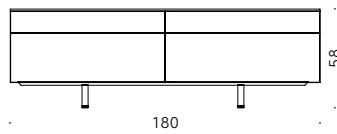

M120

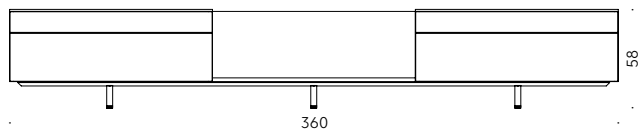
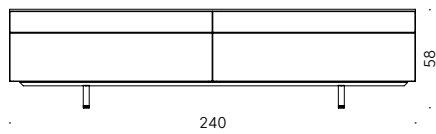
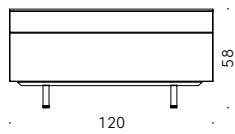

## SC16 2016



### Système de rangement

**Matériaux:**

ELEMENT DE RANGEMENT: panneaux lattés plaqués en Abonos Oak ou chêne fumé, finis avec peinture transparent à l'eau ou à base de solvant. Chant à 45° en bois massif d'Abonos Oak ou chêne fumé.

TIROIRS: latté plaqué en Abonos Oak ou chêne fumé, finis avec peinture transparent à l'eau ou à base de solvant, montés sur glissières avec mécanisme d'amortissement.

FAÇADES TIROIRS: latté plaqué en Abonos Oak ou chêne fumé, finis avec peinture transparent à l'eau ou à base de solvant. Ou tôle en laiton strié, acier strié gris ou acier délabré foncé. Chant à 45° et poignée en bois massif d'Abonos Oak ou chêne fumé.

PLAN: latté plaqué avec Abonos Oak ou chêne fumé, finis avec peinture transparent à l'eau ou à base de solvant. Ou panneau interne en aluminium structurel revêtu avec tôle en laiton strié, acier strié gris ou acier délabré foncé. Ou Marbre Grey Stone ou blanc Carrara ou Calacatta Oro, fini à la main et traité avec des produits hydrofuges. Renfort inférieur avec grillage en fibre de verre noyée avec des résines époxy.

BASE: acier peint à poudre noir mat et pied en acier bruni. Patin réglable en thermoplastique.

PIEDS: acier bruni. Patin réglable en thermoplastique.

+info:  
<http://www.depadova.com/materials.pdf>

Éléments de rangement avec pieds.

M75

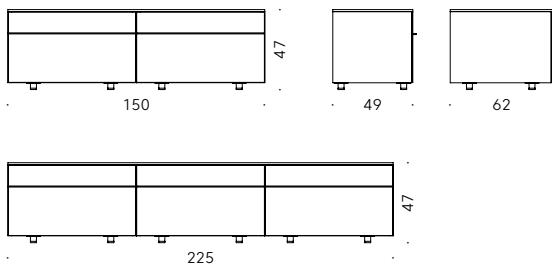

M90

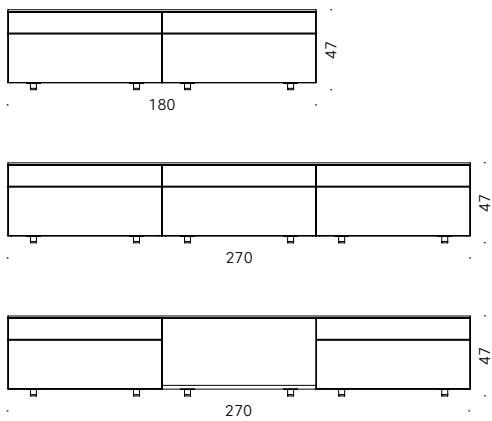

M120

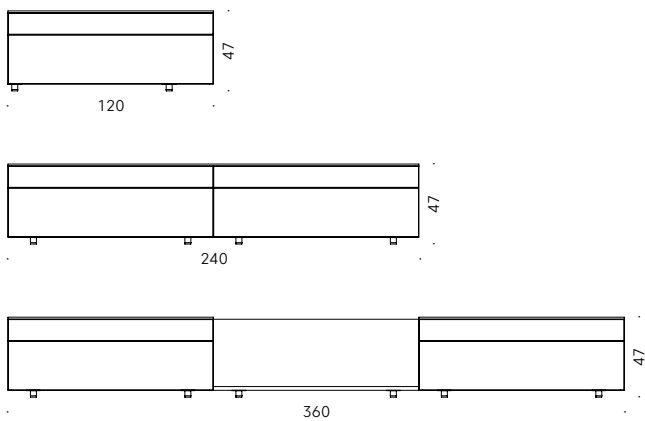

Éléments de rangement avec base.

M75

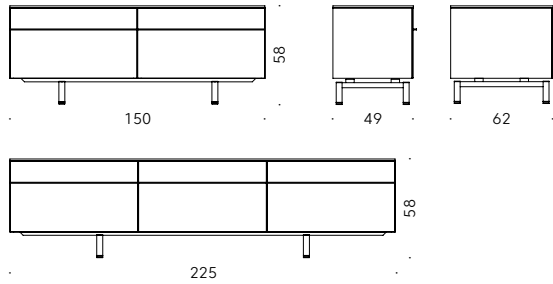

M90

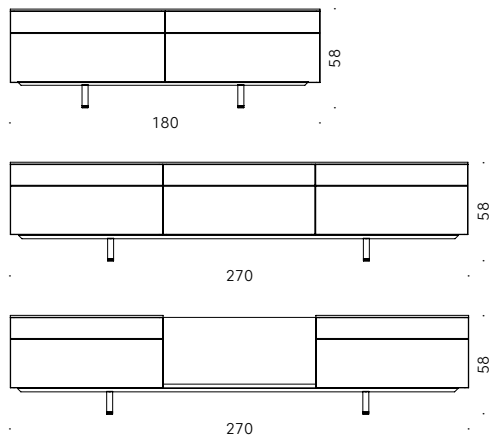

M120

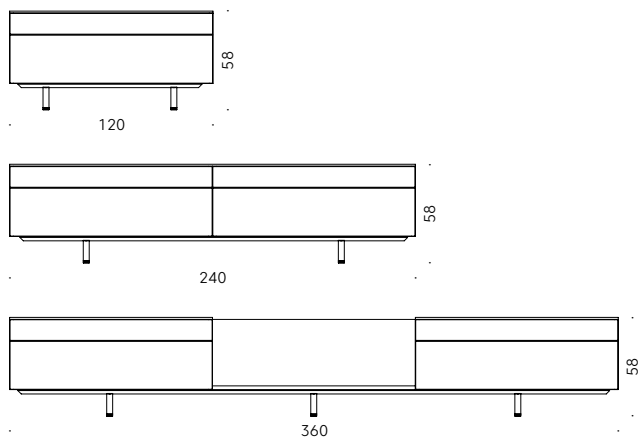

## SC16 2016



### Schranksystem

#### Materialien:

**KORPUS:** stabverleimte Holzplatten, furniert in Abonos Oak oder Räumchereiche, endbehandelt mit transparentem Lack auf Wasser- oder Lösemittelbasis. Ecke 45° aus Massivholz Abonos Oak oder Räumchereiche.

**SCHUBLADEN:** stabverleimte Holzplatten, furniert in Abonos Oak oder Räumchereiche, endbehandelt mit transparentem Lack auf Wasser- oder Lösemittelbasis. Montiert auf Führungsschienen mit Einzugsdämpfer.

**SCHUBLADENFRONTEN:** stabverleimte Holzplatten, furniert in Abonos Oak oder Räumchereiche, endbehandelt mit transparentem Lack auf Wasser- oder Lösemittelbasis. Oder hergestellt aus Blech in Messing gestreift, Stahl gestreift grau oder Stahl délabré dunkel. Ecke 45° und Griffe aus Massivholz (Abonos Oak oder Räumchereiche).

**PLATTE:** stabverleimte Holzplatten, furniert in Abonos Oak oder Räumchereiche, endbehandelt mit transparentem Lack auf Wasser- oder Lösemittelbasis. Oder Innenpaneel in Strukturaluminium mit Blech in Messing gestreift, Stahl gestreift grau oder Stahl délabré dunkel. Oder Marmor Grey Stone oder weißer Carrara-Marmor oder Marmor Calacatta Gold, von Hand endbehandelt und mit einer wasserabweisenden Schicht versehen. Untere Verstärkung aus epoxidharzgetränktem Glasfasergewebe.

**GESTELL:** Pulverlackiertes Stahlgestell mattschwarz und Fuß aus brüniertem Stahl. Verstellbarer Thermoplast-Gleitfuß.

**FÜßE:** aus brüniertem Stahl. Verstellbarer Thermoplast-Gleitfuß.

+info:

<http://www.depadova.com/materials.pdf>

Schrank mit Füßen.

M75

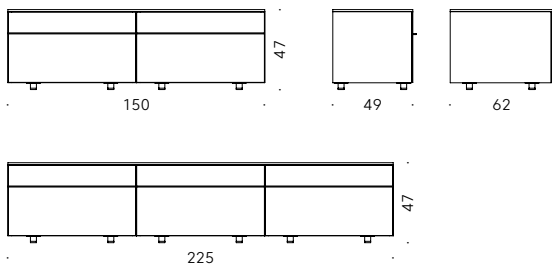

M90

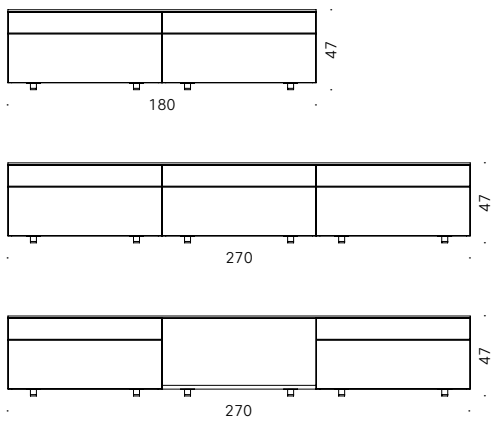

M120

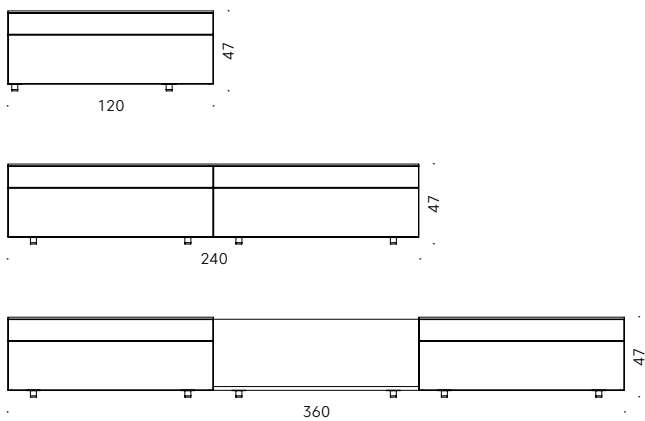

Schrank mit Gestell.

M75

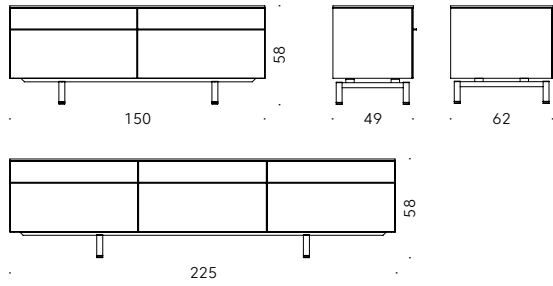

M90

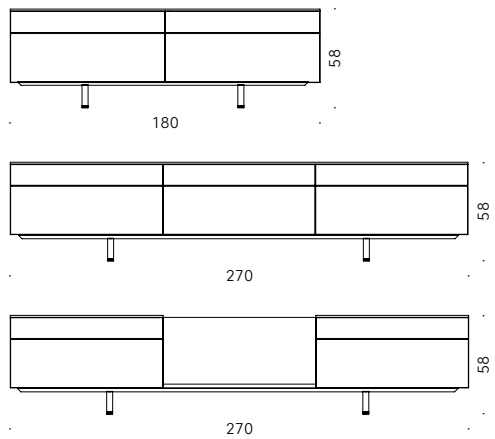

M120

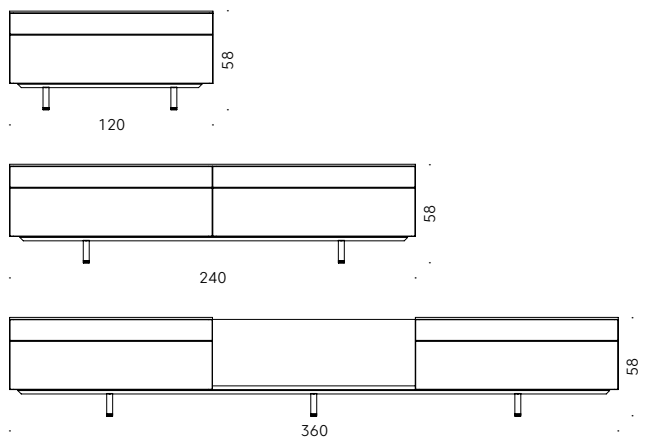



## SC16 2016



### Sistema de muebles contenedores

#### Materiales:

MUEBLE CONTENEDOR: paneles de madera alistonada contrachapada de Abonos Oak o roble ahumado, acabados con pintura transparente a base de agua o a base de disolvente. Borde a 45° de madera maciza de Abonos Oak o roble ahumado.

CAJONES: madera alistonada contrachapada de Abonos Oak o roble ahumado, acabados con pintura transparente a base de agua o a base de disolvente, montados en guías de extracción total con mecanismo de cierre amortiguado.

FRENTES CAJONES: madera alistonada contrachapada de Abonos Oak o roble ahumado, acabados con pintura transparente a base de agua o a base de disolvente, borde a 45° y tirador de madera maciza de Abonos Oak o roble ahumado. O de chapa de latón estriado, acero estriado gris o acero envejecido oscuro.

TABLERO: madera alistonada contrachapada de Abonos Oak o roble ahumado, acabados con pintura transparente a base de agua o a base de disolvente. O panel interior de aluminio estructural revestido con chapa de latón estriado, acero estriado gris o acero envejecido oscuro. O mármol Grey Stone o blanco Carrara o Calacatta Oro, acabado a mano y tratado con productos repelentes al agua. Refuerzo inferior con red de fibra de vidrio ahogada con resinas epoxídicas.

BASE: acero pintado en polvo negro mate y pie de acero bruñido. Bajo-pie ajustable de termoplástico.

PIES: acero bruñido. Bajo-pie ajustable de termoplástico.

+info:  
<http://www.depadova.com/materials.pdf>

Contenitori con piedini.

M75

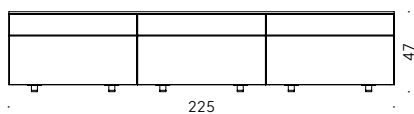
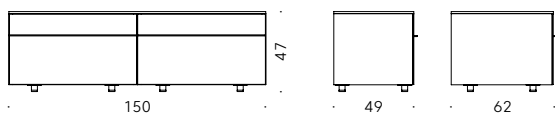

M90

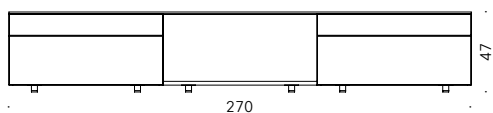
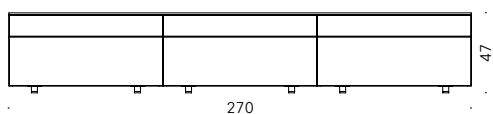
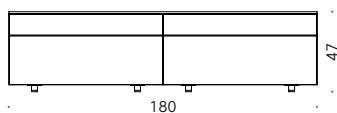

M120

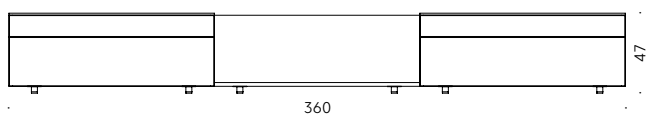
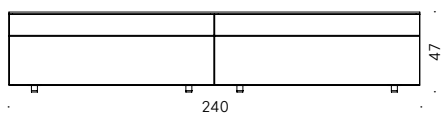
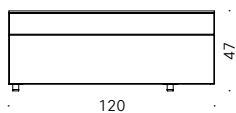

Contenitori con base.

M75

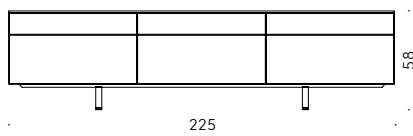
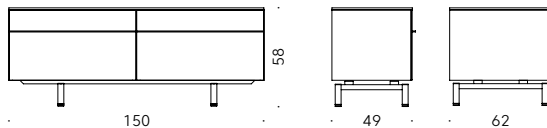

M90

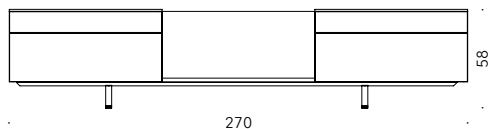
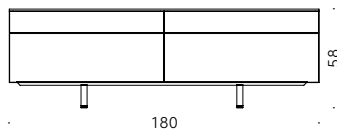

M120

