

Atalante Jasper Morrison 2009



Divano a due o più posti e divano componibile

Materiali:

STRUTTURA: legno con cinghie elastiche.

PIEDINI: materiale termoplastico.

IMBOTTITURA: poliuretano espanso a quote differenziate, memory foam e ovatta di poliestere rivestito con vellutino di poliestere e tela di cotone. Solo per il mercato UK le parti previste in memory foam vengono realizzate in poliuretano espanso. Per le versioni FR (Fire Resistant) a richiesta, i materiali dell'imbottitura sono come da normative.

RIVESTIMENTO ESTERNO: rivestimento sfoderabile in tessuto o fisco in pelle.

CUSCINI SCHIENALI (opzionale): piuma d'oca, rivestito con tela di cotone. Poggiatesta in poliuretano espanso rivestito in ovatta di poliestere.

CUSCINO VOLANTE (opzionale): piuma d'oca mista a fibra di poliestere rivestito con tela di cotone.

+info:
<http://www.depadova.com/materials.pdf>

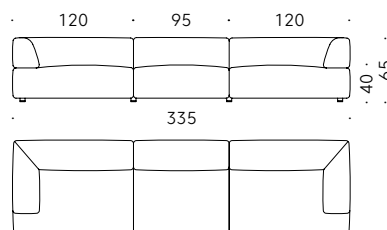
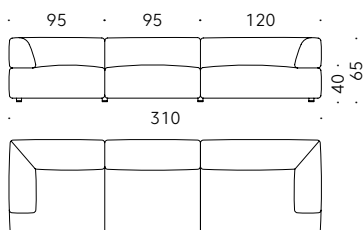
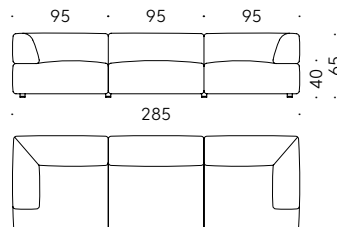
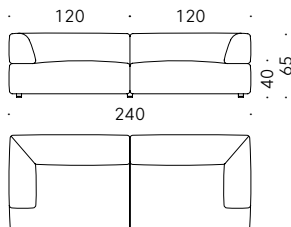
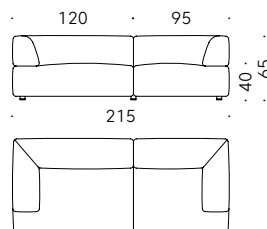
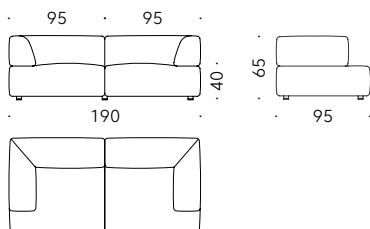

Esempi di composizione

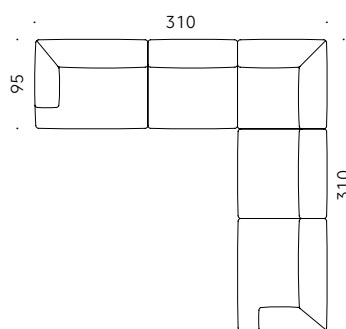
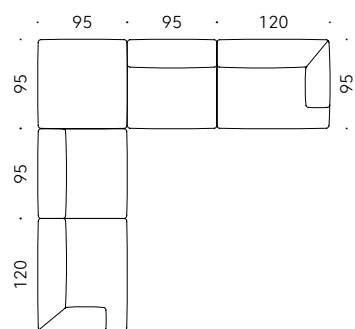
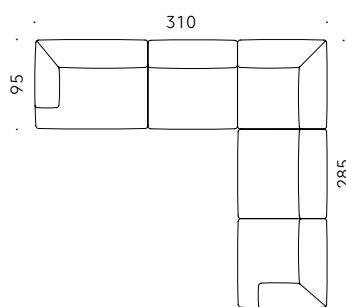
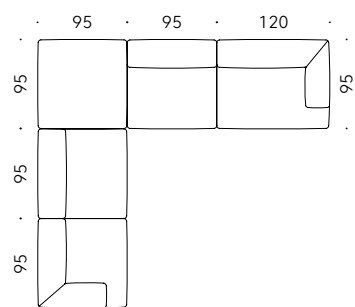
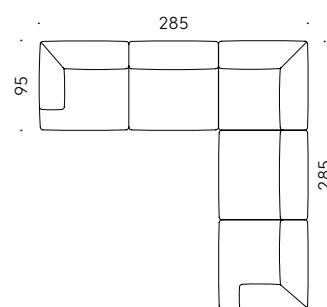
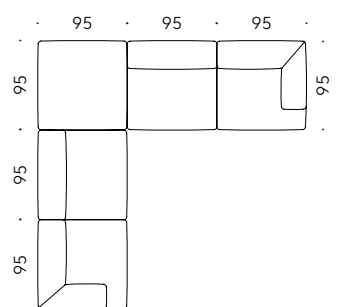
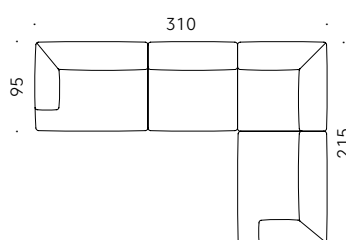
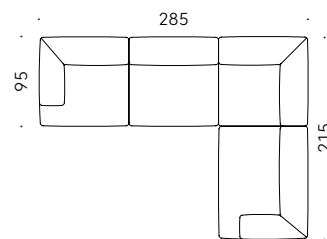
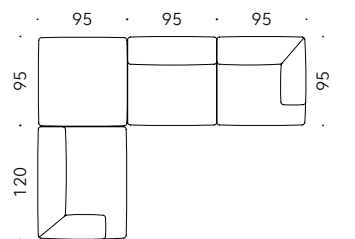

Atalante Jasper Morrison 2009



Two or more-seater sofa and modular sofa

Materials:

FRAME: wood with elastic straps.

FEET: thermoplastic material.

PADDING: variable-density foamed polyurethane, memory foam and polyester wadding, covered with polyester velveteen and cotton cloth. For UK market only the memory foam components are in foamed polyurethane. For FR (Fire Resistant) versions, padding materials follow current regulations.

EXTERNAL COVER: totally removable cover in fabric or non-removable in leather.

BACKREST CUSHIONS (optional): goose down covered in cotton cloth. Headrest in foamed polyurethane, covered with polyester wadding.

LOOSE CUSHION (optional): goose down mixed with polyester fibres, covered in cotton cloth.

+info:
<http://www.depadova.com/materials.pdf>

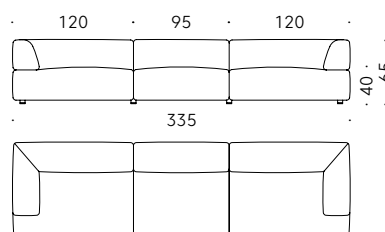
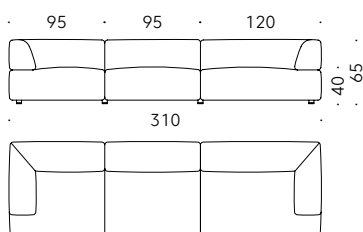
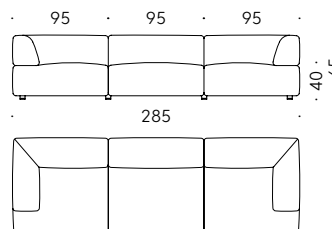
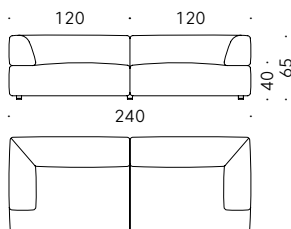
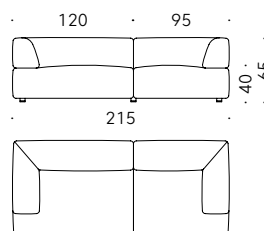
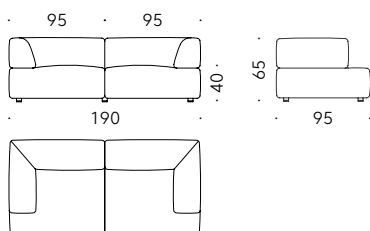

Composition Examples

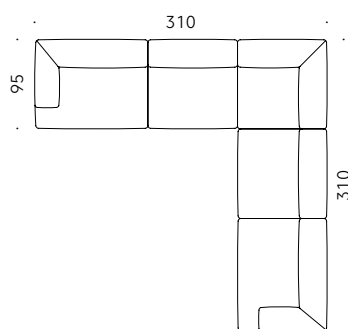
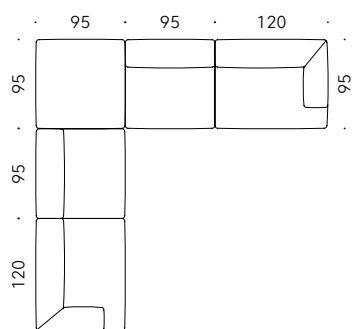
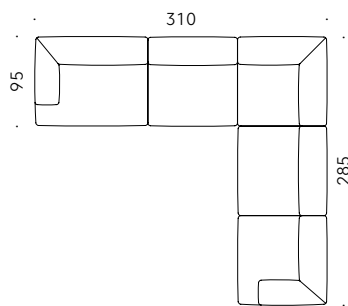
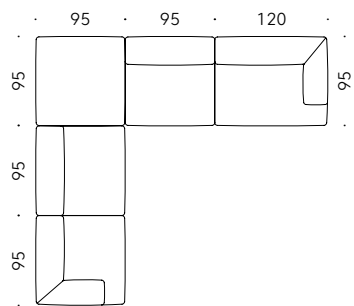
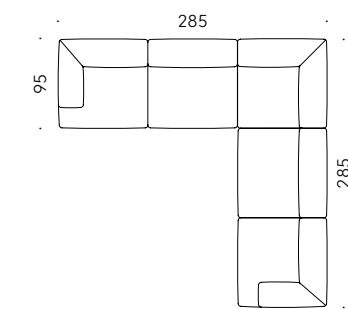
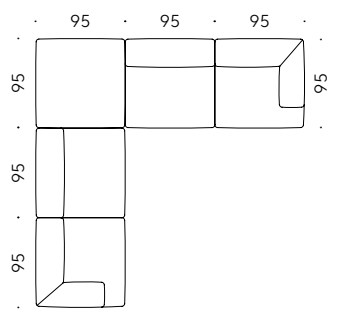
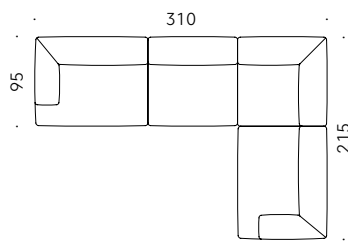
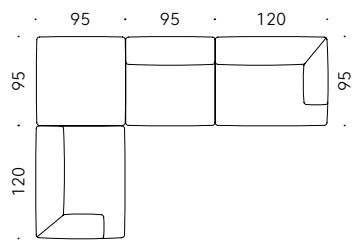
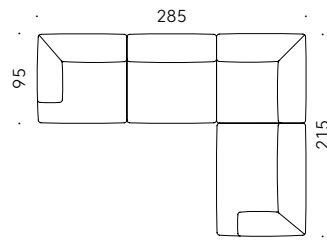
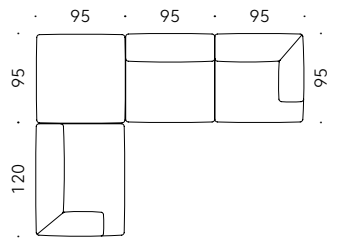

Atalante Jasper Morrison 2009

Canapé à deux places ou plus et canapé modulable



Matériaux:

STRUCTURE: bois avec sangles élastiques.

PIEDS: matière thermoplastique.

REMOBILISATION: mousse de polyuréthane à densité variable, memory foam et ouate de polyester. Uniquement pour le marché UK les parties prévues en memory foam sont réalisées en mousse de polyuréthane. Pour les versions FR (Fire Resistant) sur demande, les matériaux du rembourrage sont conformes aux réglementations.

REVÊTEMENT EXTERNE: revêtement déhoussable en tissu ou fixe en cuir.

COUSSINS DOSSIERS (option): plume d'oie, revêtue avec toile de coton. Appuie-tête en mousse de polyuréthane à densité variable revêtue en ouate de polyester.

COUSSIN AMOVIBLE (option): plume d'oie mixte avec fibre de polyester avec toile de coton.

+info:

<http://www.depadova.com/materials.pdf>

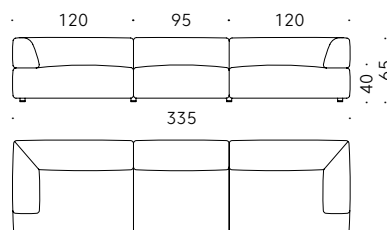
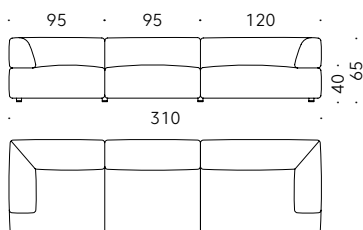
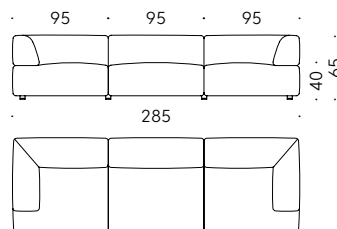
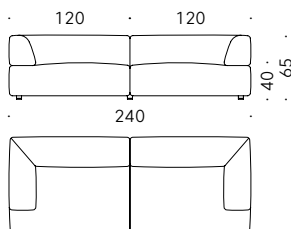
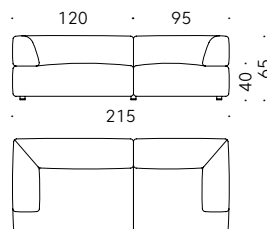
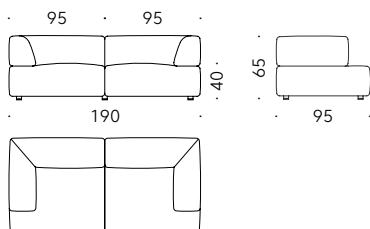

Exemples de composition

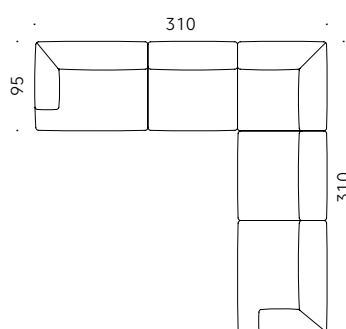
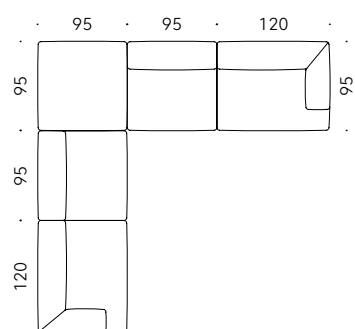
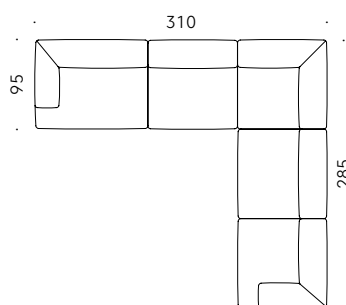
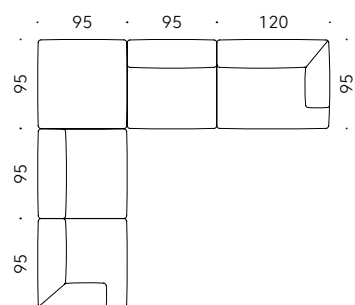
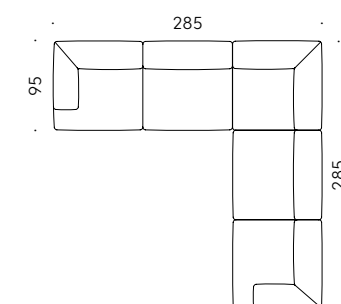
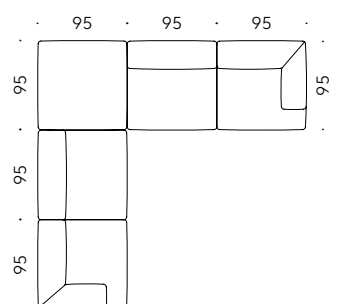
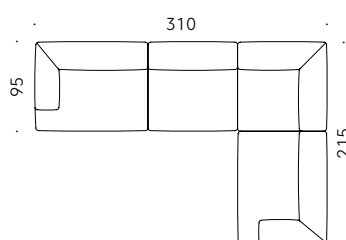
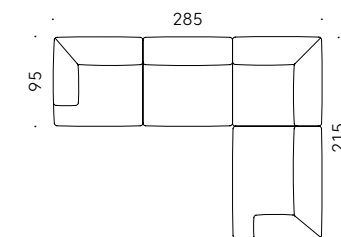
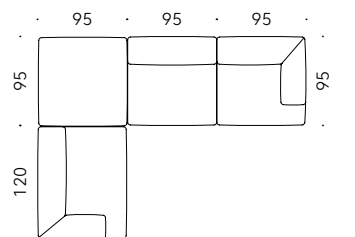

Atalante Jasper Morrison 2009

Zwei- oder mehrsitziges Sofa und modulares Sofa

Materialien:

GESTELL: Holz mit elastischen Gurten.

FÜßE: Thermoplast.

POLSTERUNG: Polyurethanschaum unterschiedlicher Dichte, Memory Schaum und Polyesterwatte. Nur für den britischen Markt sind die in Memory-Schaum vorgesehenen Teile aus Polyurethanschaum hergestellt. Bei den FR-Versionen (Fire Resistant) entsprechen die Polstermaterialien den geltenden Bestimmungen.

AUßENBEZUG: abnehmbarer Stoffbezug oder fester Lederbezug.
RÜCKENLEHNENKISSEN (optional): Gänsedaunen mit Überzug aus Baumwollgewebe. Nackenrolle aus Polyurethanschaum, mit Bezug aus Polyesterwatte.

LOSE KISSEN (optional): Gänsedaunen gemischt mit Polyesterfaser und Überzug aus Baumwollgewebe.

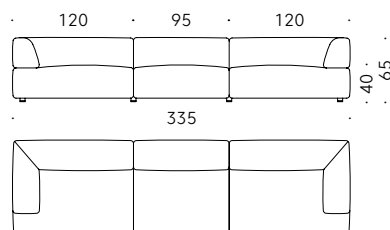
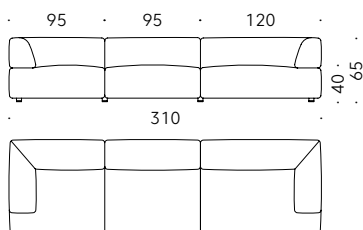
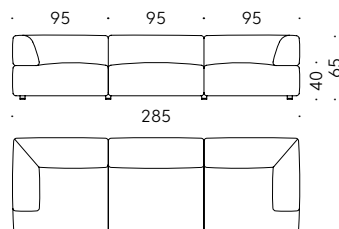
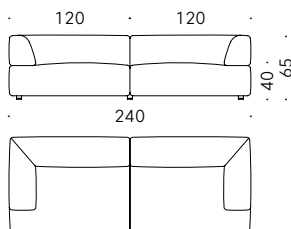
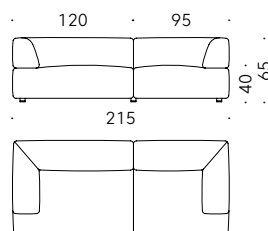
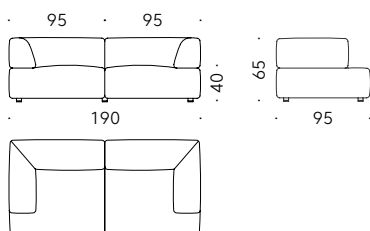

+info:

<http://www.depadova.com/materials.pdf>

Kompositionsbeispiele

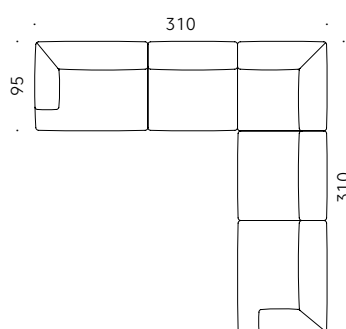
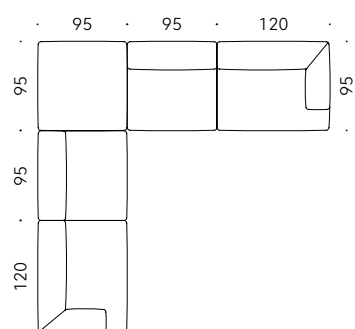
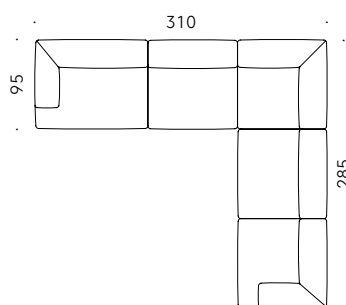
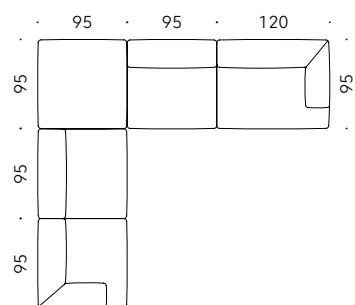
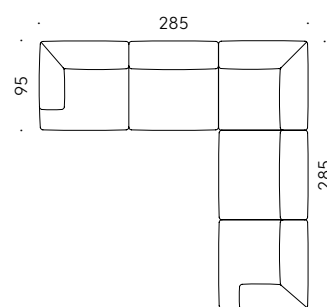
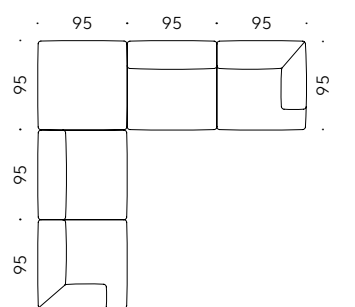
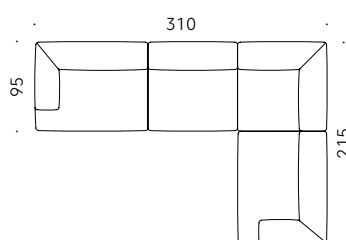
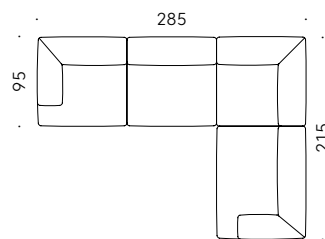
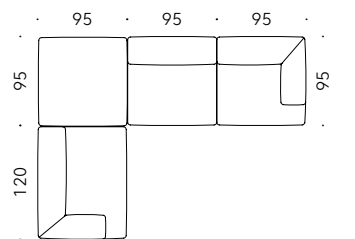

Atalante Jasper Morrison 2009



Sofá de dos o más plazas y sofá modular

Materiales:

ESTRUCTURA: madera con cinchas elásticas.

PIES: material termoplástico.

RELLENO: espuma de poliuretano de densidad diferente, memory foam y guata de poliéster. Solo para el mercado UK las partes previstas en memory foam se realizan en espuma de poliuretano. Para las versiones FR (Fire Resistant) bajo pedido, los materiales del relleno cumplen con las normativas.

TAPIZADO EXTERIOR: tapizado desenfundable de tejido o fijo de piel.

COJINES RESPALDOS (opcionales): plumas de oca, revestido con tela de algodón. Cojín reposacabezas: espuma de poliuretano revestido de guata de poliéster.

COJÍN SUELTO (opcionales): plumas de oca mixtas con fibra de poliéster revestido con tela de algodón.

+info:

<http://www.depadova.com/materials.pdf>

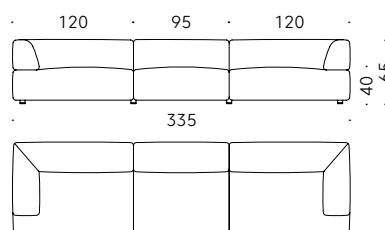
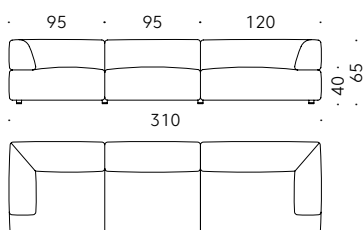
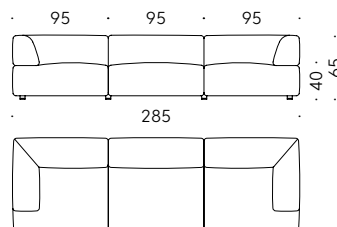
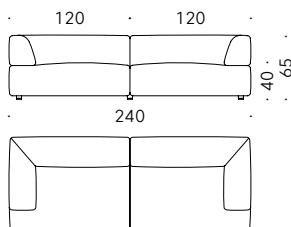
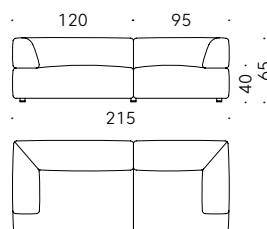
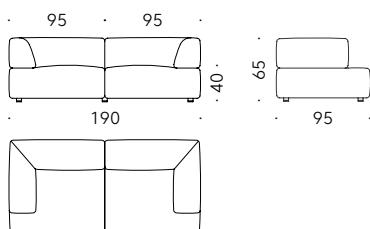

Ejemplos de composición

