

Collection BRIO Noyer

rochebobois
PARIS

design Sacha Lakic



AC321

Collection BRIO Noyer

design Sacha Lakic

rochebobois
PARIS



Buffet – Sideboard – Aparador

AC321

Collection BRIO Noyer

rochebobois
PARIS

design Sacha Lakic

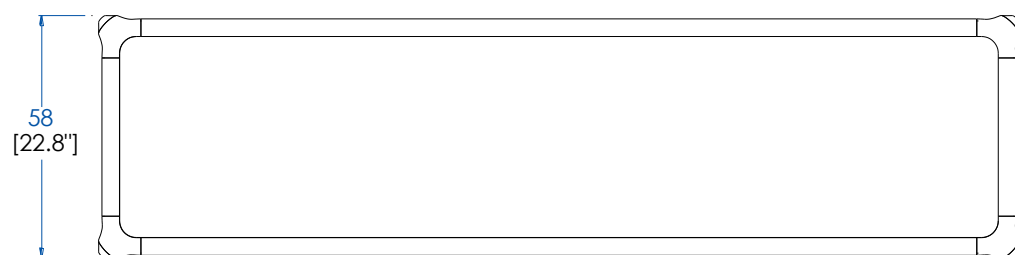
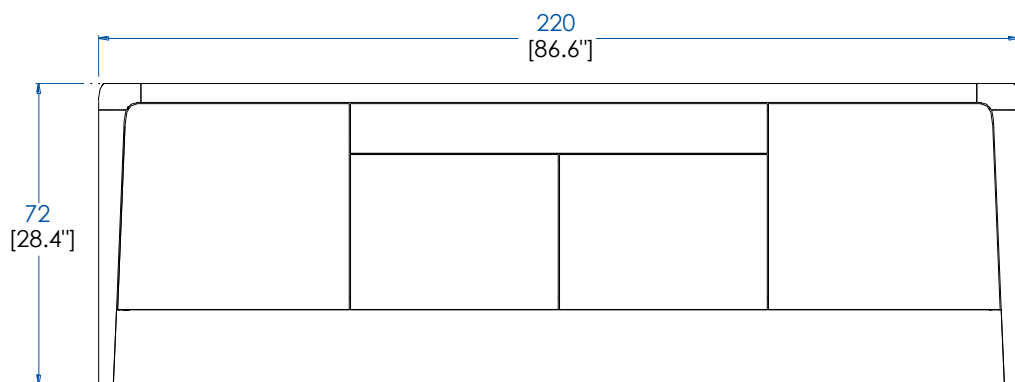

CTBR.AP01NK – Buffet – L 220 H 72 P 58 cm

Buffet 4 portes, 1 tiroir, structure en noyer massif, façades et côtés en plaqué noyer, intérieur 2 étagères en verre épaisseur 8 mm. Plateau céramique aspect marbre.
Fabrication européenne

CTBR.AP01NK - Sideboard – L 86,61" H 28,35" P 22,83"

Sideboard with 4 doors, 1 drawer. Structure in solid walnut, facades and sides in walnut veneer, interior with two 8mm-thick glass shelves. Top in marble-like ceramic.
Manufactured in Europe.

CTBR.AP01NK - Aparador

Aparador con 4 puertas y 1 cajón, estructura de nogal macizo, frontales y laterales en chapado nogal, interior 2 estantes en cristal (grosor 8 mm.). Sobre en cerámica aspecto mármol.
Fabricación europea

Collection BRIO Noyer

design Sacha Lakic

rochebobois
PARIS



Table de Repas – Dining Table – Mesa de Comedor

AC321

Collection BRIO Noyer

design Sacha Lakic

rochebobois
PARIS



AC321

Collection BRIO Noyer

rochebobois
PARIS

design Sacha Lakic

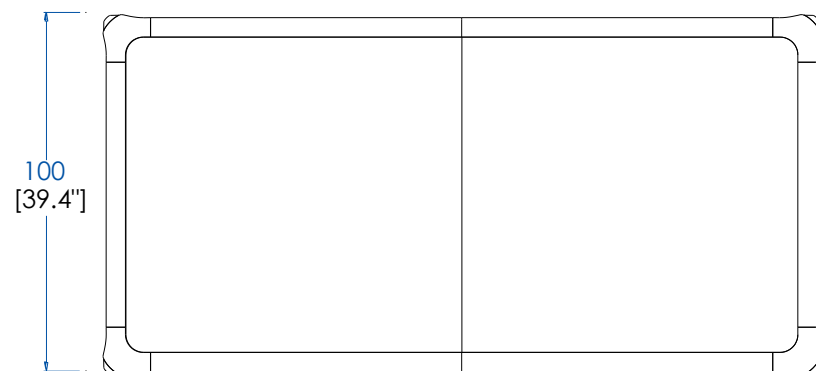
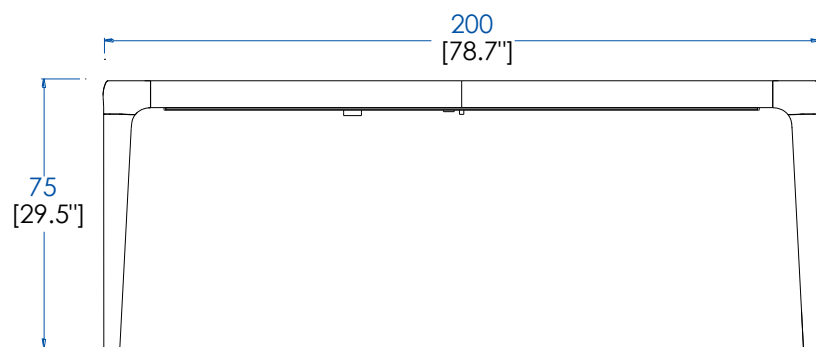

CTBR.MS01NK - Table de repas rectangulaire - avec allonge – L 200 H 75 P 100 cm

Table repas avec 1 allonge automatique de 60cm, structure en noyer massif, plateau céramique aspect marbre.

Fabrication européenne

CTBR.MS01NK - Rectangular dining table - with extension Leaf – L 78,74" H 29,53" P 39,37"

Dining table with one 60cm extension leaf, structure in solid walnut, fixed top in marble-like ceramic. Manufactured in Europe.

CTBR.MS01NK - Mesa de comedor rectangular – con extensión

Mesa de comedor con 1 extensión automática de 60 cm, estructura de nogal macizo, sobre cerámica aspecto mármol.

Fabricación europea.

Collection BRIO Noyer

rochebobo
PARIS

design Sacha Lakic

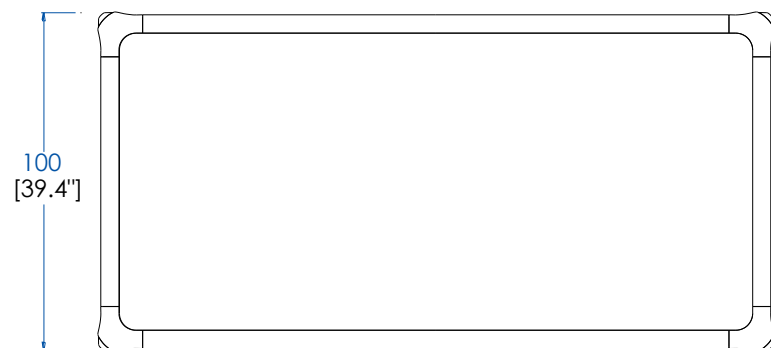
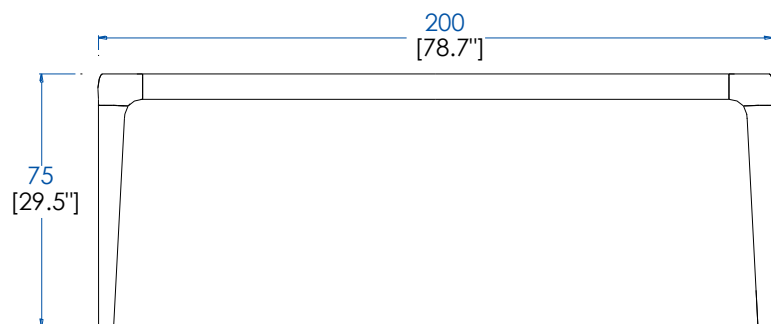

CTBR.MS01FNK - Table de repas rectangulaire - sans allonge – L 200 H 75 P 100 cm

Table repas fixe, structure en noyer massif, plateau fixe en céramique aspect marbre.
Fabrication européenne

CTBR.MS01FNK - Rectangular dining table – without extension leaf – L 78,74" H 29,53" P 39,37"

Fixed dining table with structure in solid walnut, fixed top in marble-like ceramic.
Manufactured in Europe.

CTBR.MS01FNK - Mesa de comedor rectangular – sin extensión

Mesa de comedor fija, estructura en nogal macizo, sobre fijo en cerámica aspecto mármol.
Fabricación europea

Collection BRIO Noyer

design Sacha Lakic

rochebobois
PARIS



Console – Console – Consola

AC321

Collection BRIO Noyer

rochebobois
PARIS

design Sacha Lakic

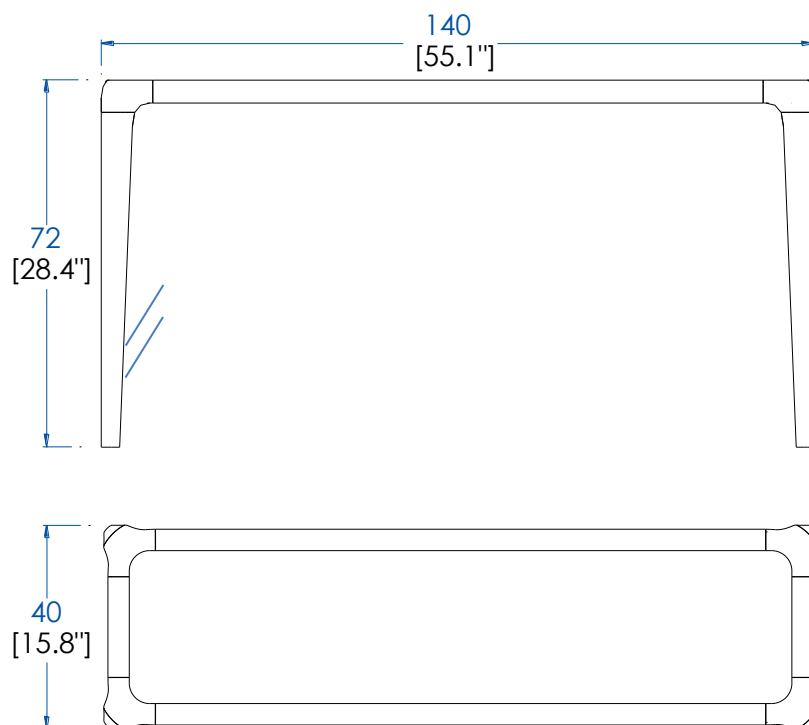

CTBR.CL01NV – Console - L 140 H 72 P 40 cm

Console, structure en noyer massif, plateau en verre fumé bronze épaisseur 8 mm.
Fabrication européenne

CTBR.CL01NV – Console – L 55,12" H 28,35" P 15,75"

Console, structure in solid walnut, top in 8mm-thick smoked bronze glass.
Manufactured in Europe.

CTBR.CL01NV – Consola

Consola con estructura de nogal macizo, sobre de cristal ahumado bronce (grosor 8 mm.).
Fabricación europea

CTBR.CL01NVF – Console - L 140 H 72 P 40 cm

Console, structure en noyer massif, plateau en verre fumé acidé épaisseur 8 mm.
Fabrication européenne

CTBR.CL01NVF – Console – L 55,12" H 28,35" P 15,75"

Console, structure in solid walnut, top in 8mm-thick smoked acid glass.
Manufactured in Europe.

CTBR.CL01NVF – Consola

Consola con estructura de nogal macizo, sobre de cristal ahumado al ácido (grosor 8 mm.).
Fabricación europea

Collection BRIO Noyer

design Sacha Lakic

rochebobois
PARIS



Table Basse Carrée – Square Cocktail Table – Mesa de Centro Cuadrada

AC321

Collection BRIO Noyer

rochebobois
PARIS

design Sacha Ladic

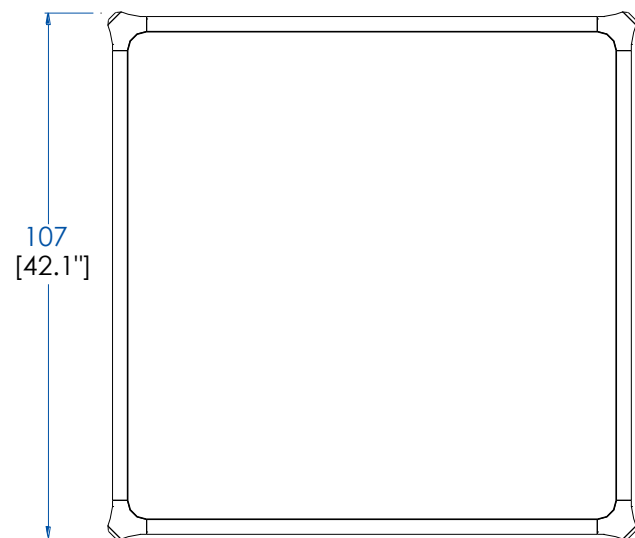
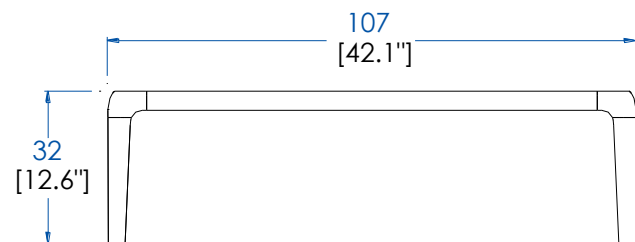

CTBR.MC01NK - Table basse carrée – L 107 H 32 P 107 cm

Table basse, structure en noyer massif, plateau en céramique aspect marbre.
Fabrication européenne

CTBR.MC01NK - Square cocktail table – L 42,13" H 12,60" P 42,13"

Cocktail table with structure in solid walnut, top in marble-like ceramic.
Manufactured in Europe.

CTBR.MC01NK - Mesa de centro cuadrada

Mesa de centro con estructura en nogal macizo, sobre en cerámica aspecto mármol.
Fabricación europea

Collection BRIO Noyer

rochebobo
PARIS

design Sacha Lakic

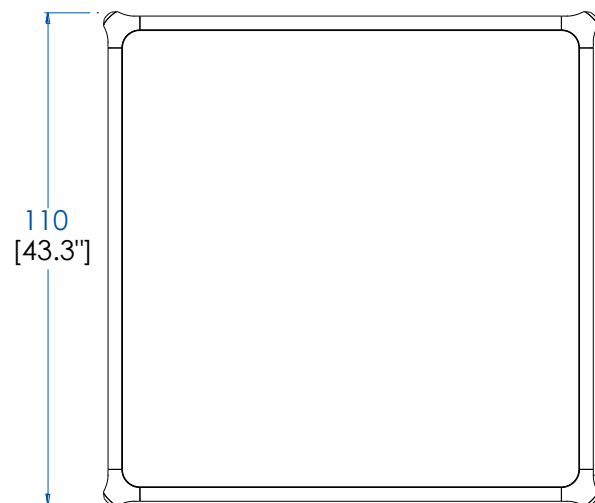
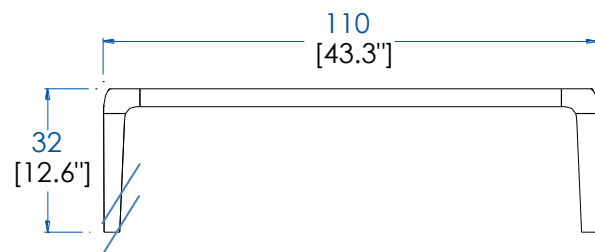

CTBR.MC01NV – Table basse carrée - L 110 H 32 P 110 cm

Table basse, structure en noyer massif, plateau en verre fumé bronze épaisseur 8 mm.
Fabrication européenne

CTBR.MC01NV – Square cocktail table – L 43,31" H 12,60" P 43,31"

Cocktail table with structure in solid walnut, top in 8mm-thick smoked bronze glass.
Manufactured in Europe.

CTBR.MC01NV – Mesa de centro cuadrada

Mesa de centro con estructura en nogal macizo, sobre de cristal ahumado bronce (grosor 8 mm).
Fabricación europea.

CTBR.MC01NVF – Table basse carrée - L 110 H 32 P 110 cm

Table basse, structure en noyer massif, plateau en verre fumé acidé épaisseur 8 mm.
Fabrication européenne

CTBR.MC01NVF – Square cocktail table – L 43,31" H 12,60" P 43,31"

Cocktail table with structure in solid walnut, top in 8mm-thick smoked acid glass.
Manufactured in Europe.

CTBR.MC01NVF – Mesa de centro cuadrada

Mesa de centro con estructura en nogal macizo, sobre de cristal ahumado al ácido (grosor 8 mm).
Fabricación europea.

Collection BRIO Noyer

design Sacha Lakic

rochebobois
PARIS



Table Basse Rectangulaire – Rectangular Cocktail Table – Mesa de Centro Rectangular

AC321

Collection BRIO Noyer

rochebobois
PARIS

design Sacha Lakic

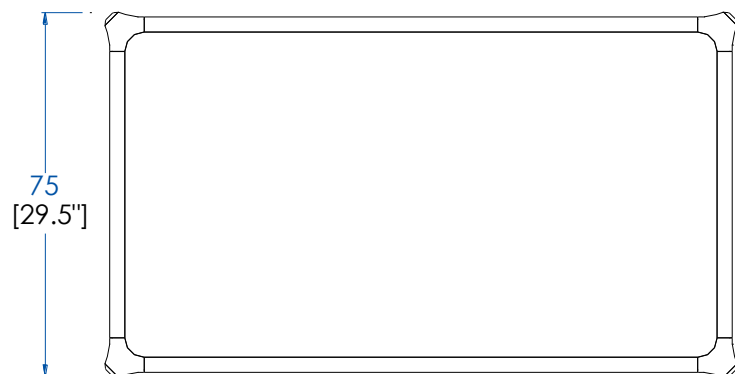
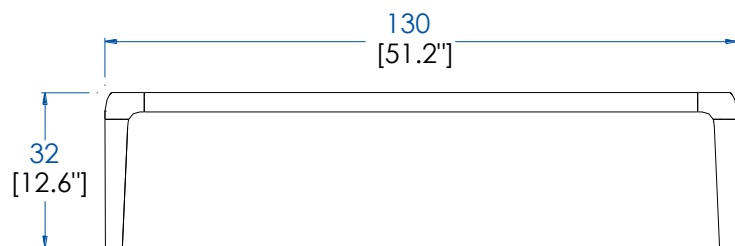

CTBR.MC02NK - Table basse rectangulaire – L 130 H 32 P 75 cm

Table basse, structure en noyer massif, plateau en céramique aspect marbre.
Fabrication européenne

CTBR.MC02NK - Rectangular cocktail table – L 51,18" H 12,60" P 29,53"

Cocktail table with structure in solid walnut, top in marble-like ceramic.
Manufactured in Europe

CTBR.MC02NK - Mesa de centro rectangular

Mesa de centro con estructura en nogal macizo, sobre de cerámica aspecto mármol.
Fabricación europea.

Collection BRIO Noyer

rocheboboys
PARIS

design Sacha Lakic

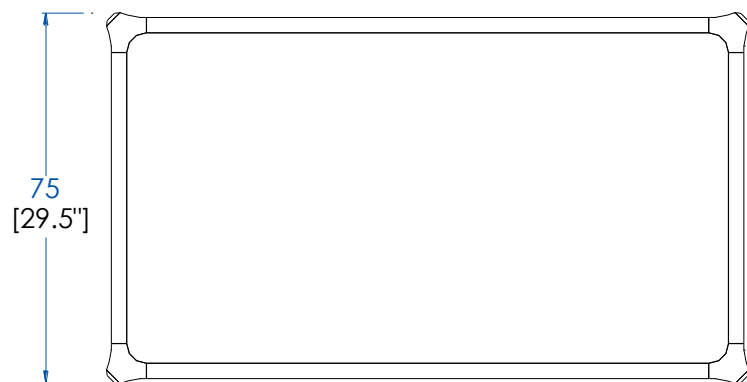
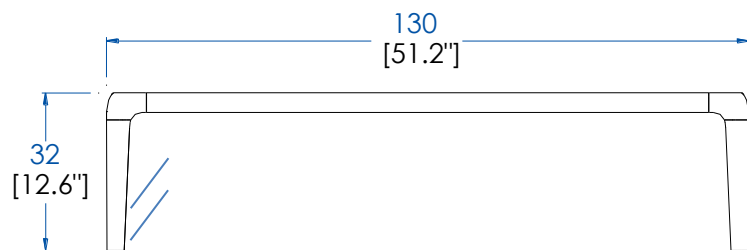

CTBR.MC02NV - Table basse rectangulaire – L 130 H 32 P 75 cm

Table basse, structure en noyer massif, plateau en verre fumé bronze épaisseur 8 mm.
Fabrication européenne

CTBR.MC02NV - Rectangular cocktail table – L 51,18" H 12,60" P 29,53"

Cocktail table with structure in solid walnut, top in 8mm-thick smoked bronze .
Manufactured in Europe

CTBR.MC02NV - Mesa de centro rectangular

Mesa de centro con estructura en nogal macizo, sobre de cristal ahumado bronce.
Fabricación europea.

CTBR.MC02NVF - Table basse rectangulaire – L 130 H 32 P 75 cm

Table basse, structure en noyer massif, plateau en verre fumé acidé épaisseur 8 mm.
Fabrication européenne

CTBR.MC02NVF - Rectangular cocktail table – L 51,18" H 12,60" P 29,53"

Cocktail table with structure in solid walnut, top in 8mm-thick smoked acid glass.
Manufactured in Europe

CTBR.MC02NVF - Mesa de centro rectangular

Mesa de centro con estructura en nogal macizo, sobre de cristal ahumado al ácido (grosor 8 mm).
Fabricación europea.

Collection BRIO Noyer

design Sacha Lakic

rochebobois
PARIS



Bout de Canapé – End Table – Mesa de Rincón

AC321

Collection BRIO Noyer

rochebobo
PARIS

design Sacha Lakic

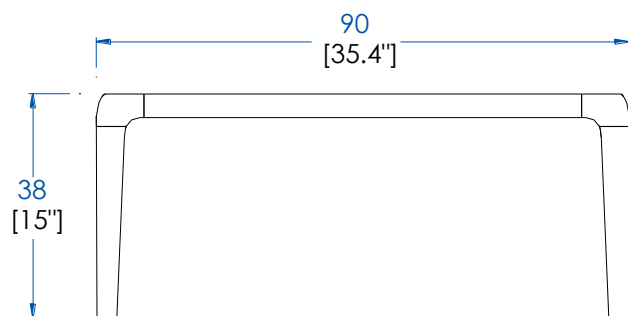

CTBR.MA01NK - Bout de canapé – L 90 H 38 P 65 cm

Bout de canapé, structure en noyer massif, plateau en céramique aspect marbre.
Fabrication européenne

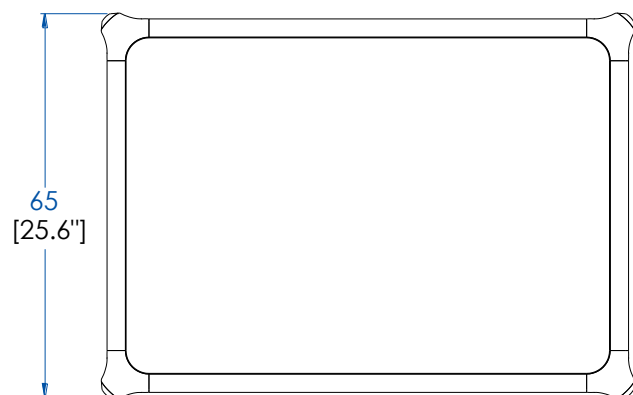

CTBR.MA01NK - End table – L 35,43" H 14,96" P 25,59"

End table with structure in solid walnut, top in marble-like ceramic.
Manufactured in Europe

CTBR.MA01NK - Mesa de rincón

Mesa de rincón con estructura en nogal macizo, sobre en cerámica aspecto mármol.
Fabricación europea.

Collection BRIO Noyer

rochebobois
PARIS

design Sacha Ladic

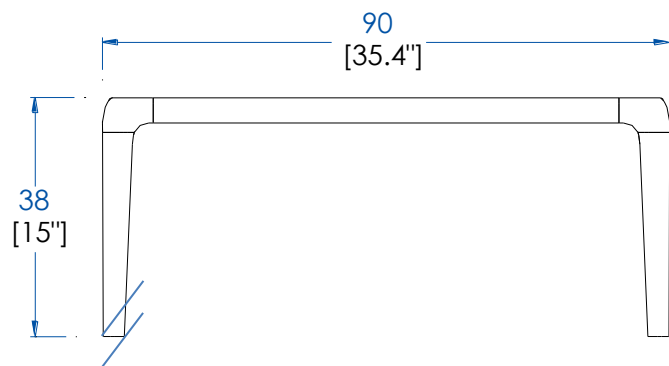

CTBR.MA01NV - Bout de canapé – L 90 H 38 P 65 cm

Bout de canapé, structure en noyer massif, plateau en verre fumé bronze.
Fabrication européenne

CTBR.MA01NV - End table – L 35,43" H 14,96" P 25,59"

End table with structure in solid walnut, top in 8mm-thick smoked bronze.
Manufactured in Europe

CTBR.MA01NV - Mesa de rincón

Mesa de rincón con estructura en nogal macizo, sobre de cristal ahumado bronce.
Fabricación europea.

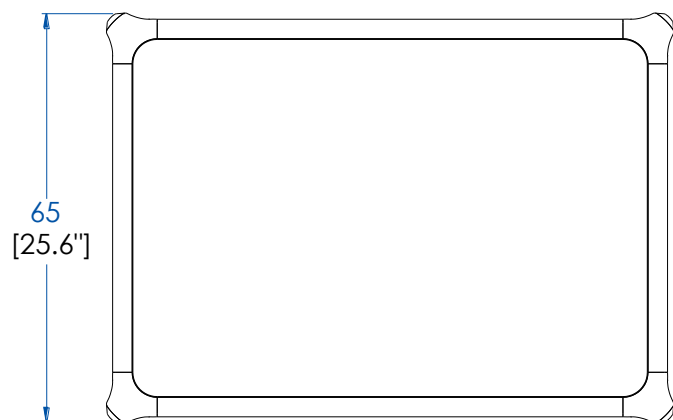

CTBR.MA01NVF - Bout de canapé – L 90 H 38 P 65 cm

Bout de canapé, structure en noyer massif, plateau en verre fumé acide épaisseur 8 mm.
Fabrication européenne

CTBR.MA01NVF - End table – L 35,43" H 14,96" P 25,59"

End table with structure in solid walnut, top in 8mm-thick smoked acid glass.
Manufactured in Europe

CTBR.MA01NVF - Mesa de rincón

Mesa de rincón con estructura en nogal macizo, sobre de cristal ahumado al ácido (grosor 8mm)
Fabricación europea.