



WALL

design Piero Lissoni

Modular elements of different sizes with frame in double-panelled poplar and pine and support in cross-woven, coated rubber elastic straps. Padding in differentiated density polyurethane foam with covering in needle punched, resinated, nonwoven polyester fibre, bonded onto a polyamide velveteen backing.

Black adjustable PVC feet. Fabric or leather upholstery. The fabric version only is fully removable by Velcro fastenings. The various elements are joined together by means of hooks. Seat depth: 68–94 cm.

Notes

Backs and seats upholstered in leather might have additional stitching.

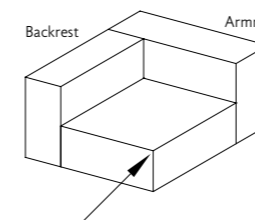

Stitching for corner element.

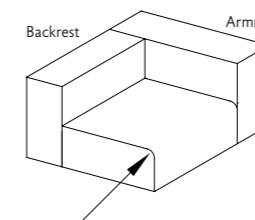

Stitching for element with armrest. The seat of the end element is curved on one side. When in composition, the element must be joined from the side shown by the arrow.

On request can be ordered a spacer, to lift the elements of further 4 cm, to be screwed to the standard feet.

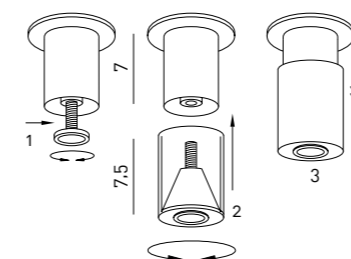

Modular elements are fitted with hooks for assembly.

Hooks for assembly elements with standard feet in PVC.

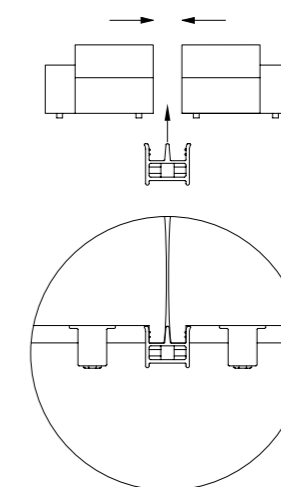

Hooks for assembly elements with feet with spacers.

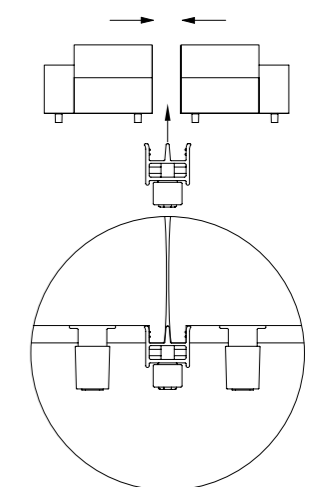

For composition with different elements, please attach a general sketch to the order.

Technical Drawings

Terminal Element with high armrest

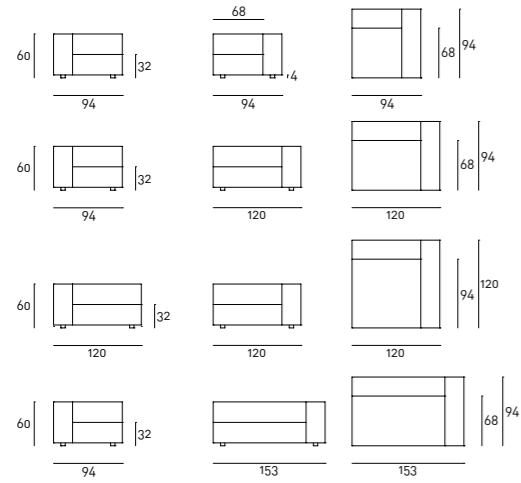

Central Element

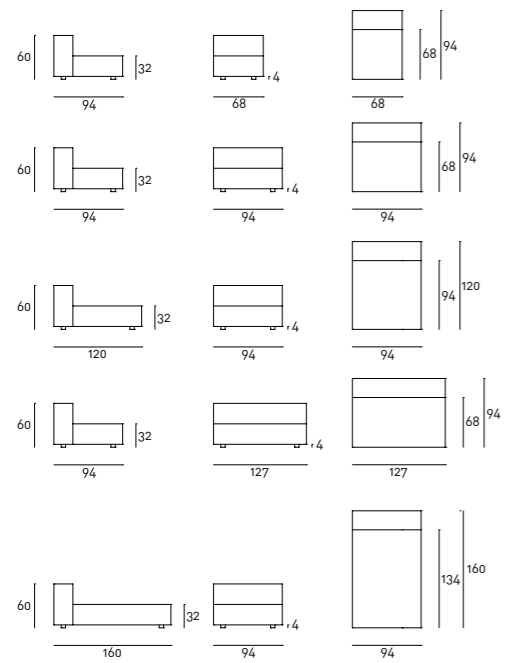

Footrest

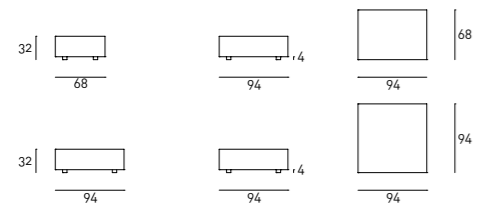

Terminal Element with low armrest

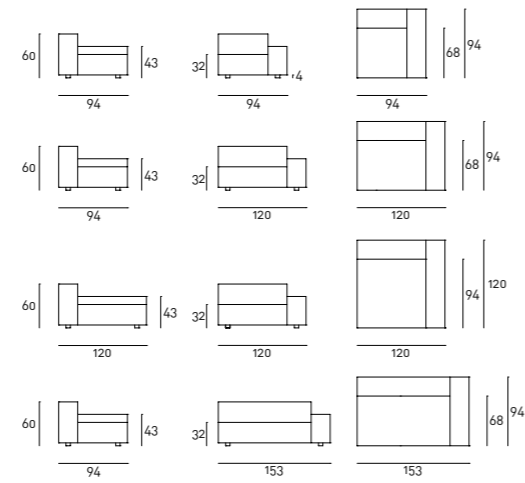

Corner Element

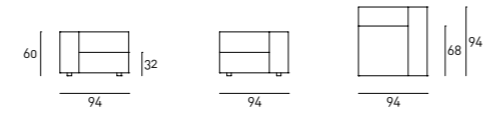

Long Seat

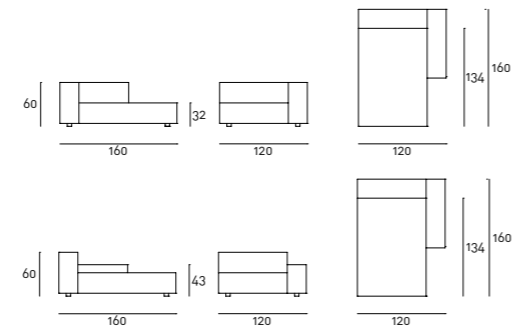

Loose Cushion

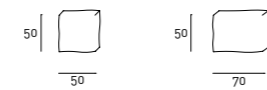

Examples of Composition

Composition 01

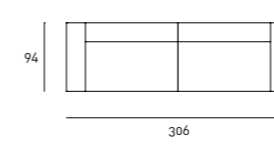

WA1T153A SX
WA1T153A DX

Composition 02

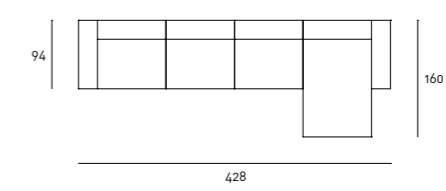

WA1T094A SX
WA1E094
WA1E094
WA1S160B DX

Composition 03

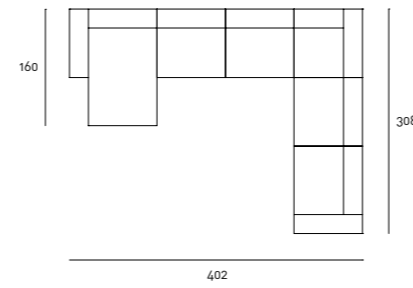

WA1S160A SX
WA1E094
WA1E094
WA1A094
WA1E094
WA1T094B DX

The commercial codes refer to the elements chosen in the above-proposed compositions.

