



NOTES (INDOOR + OUTDOOR) + LAZY SUSAN

design Massimo Mariani

Notes

Table available for indoor and outdoor, with granite, smoked grey glass or blu-tinted glass top (indoor/outdoor use), wood, marble or clear glass top (indoor use only).

Indoor/outdoor version: Ø30mm tubular steel frame with junction steel bar, section 80x15mm, coated with polyester epoxy powder gunmetal colour with black PVC tips.

Top in black absolute Zimbabwe granite or in marble white Carrara, black Marquina, Sahara Noir or red Levanto, with an undertop in black HPL, fitted with small plate with a conical counterbore to align and fix it to the base. The marble version provides a satin finish and an opaque transparent protective varnish or a matt or glossy polyester finish.

Top in wood, with water-based acrylic paint finish, made in "sandwich" of MDF and aluminum sheet pressed and glued together, veneered with 10/10 plates of chestnut, natural or charcoal dyed or Stone Oak®; beveled edge and bottom always matt satin lacquered in the finish of the top. Top in 12mm tempered clear glass or smoked glass, or in 10mm tempered blue-tinted glass to which are fixed, with a UV-cured adhesive, small plates with a conical counter bore to align it with the structure. All top versions are secured to the frame by means of tie rods.

Lazy Susan

Circular central plate, available in marble or wood, dimensions Ø70, Ø90 and Ø110 h4cm, made of a supporting base in black HPL, thickness 10mm, and a swivelling mechanism "sandwiched" between the top and the support. Table top support secured by black PVC tips.

Top in marble: top with thickness 20mm with bevelled edge, available in black Marquina, white Carrara, red Levanto or Sahara Noir with glossy polyester finishing.

Top in wood: top made of MDF (thickness 20mm) with beveled edge, and upper part and edge veneered with 10/10 plates in natural chestnut, charcoal dyed chestnut or Stone Oak® with acrylic painting finish; beveled edge and lower part always lacquered in the same finishing of the top.

Structure

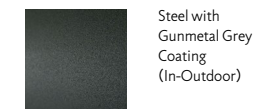

Top

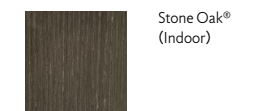
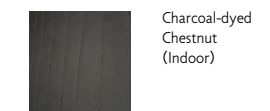
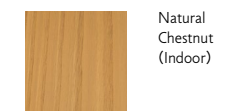
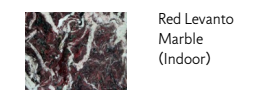
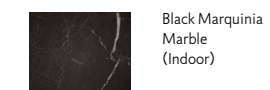
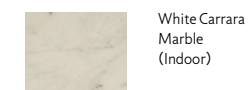
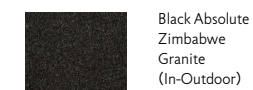

Lazy Susan (only Indoor)

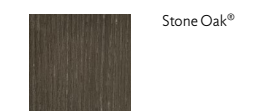
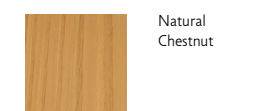
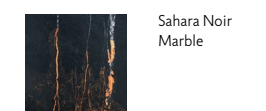
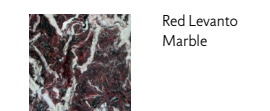
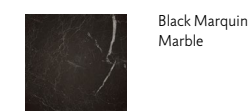
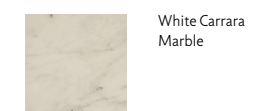

Technical Drawings
Table

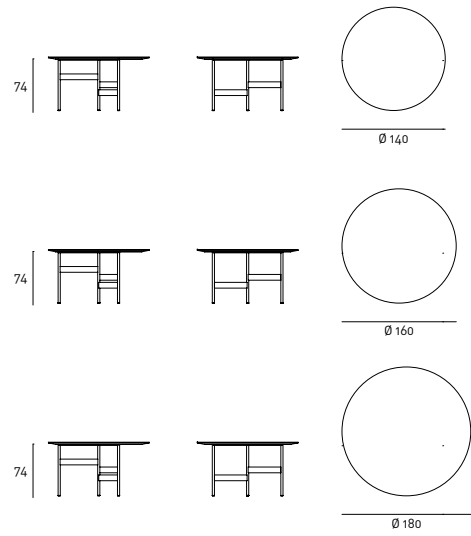

Lazy Susan - Marble

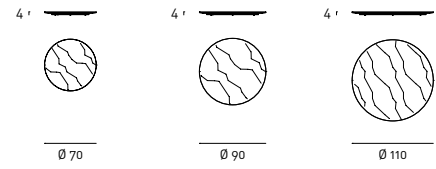

Lazy Susan - Wood

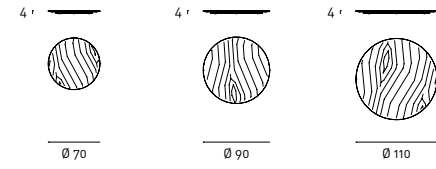
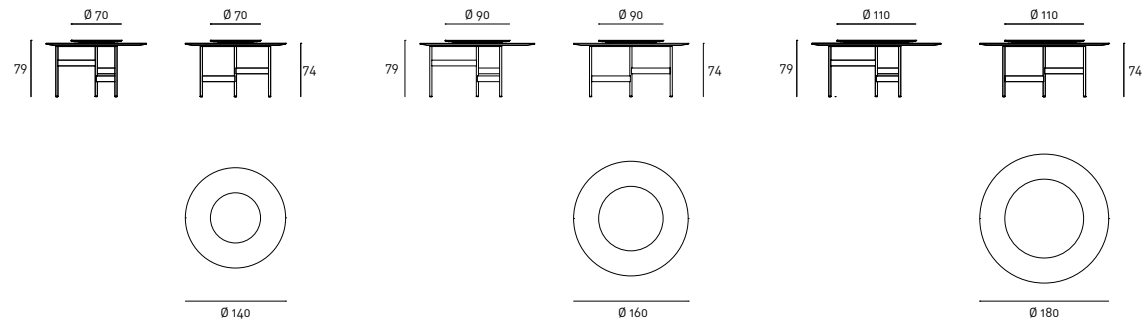

Table + Lazy Susan



Notes

Granite: of uniform colour, granite is a hard stone of volcanic origin and is an "intrusive rocks", which emerge from solidified magma inside the earth's crust; for its particular nature, granite is a very resistant material to abrasion and compression and easy to be maintained.

Stone Oak®: this wood owes its particular coloring to an entirely natural process. Because of this, some slabs may look more brown than others. Our commitment is to provide you a high quality product; any differences in color should not be considered as defects.

On request, an additional protective (acrylic solvent) painting is available for the Stone Oak® finishing only. It should be noted that this additional coating slightly changes the natural color and texture of the surface. Although this supplementary painting increases the surface resistance, it is still a natural material; therefore small superficial stains, due to oil or other substances, have to be promptly removed, before being absorbed in depth by the wood. Thus, we recommend regular care and maintenance.

For the marble top version please specify the required finish in the order.

Although the Lazy Susan can endure high temperatures, it is advisable to avoid placing (directly on the top) tools just removed from heat sources. The direct contact with overheated objects could cause indelible stains or crevices, created by the thermal shock. Therefore, it is advisable to always use a trivet to place the dishes on the surface.



—
Notes table with top veneered in
charcoal-dyed chestnut and Lazy Susan in
Sahara Noir marble



—
Notes table with top in granite



