

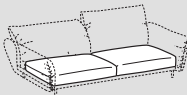

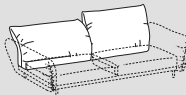

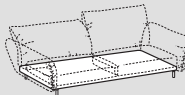



# On Line Plain



	 Seduta - Seat	 Schienali - Backrests	 Struttura - Structure	
<b>Rivestimento Upholstering (8)</b>	Sfoderabile Removable 	Sfoderabile Removable 	Sfoderabile Removable 	
	Non sfoderabile Not removable -	Non sfoderabile Not removable -	Non sfoderabile Not removable -	
<b>Imbottiture Padding (4-5-6-7)</b>	 D.35kg/m³	 D.21kg/m³	 D.21kg/m³	 Optional

## INFORMAZIONI TECNICHE

### Struttura: 1-2

Masselli portanti in legno di abete e faggio di vari spessori. Fianchi di tamponamento in pannelli di legno multistrati e particelle di legno in classe E1, particolari in pannelli di fibra di legno dura o cellulosa.

### Molleggio: 1-3

Schienali in pannelli di fibra di legno dura o cellulosa e nastri elastici di fibra propilenica e lattice, meccanicamente pretensionati.

Seduta in nastri elastici di fibra propilenica e lattice incrociati e meccanicamente pretensionati.

### Note:

Gli schienali hanno al loro interno un meccanismo frizionato in metallo (10) che permette la funzione di sollevamento / abbassamento dello schienale nella posizione desiderata. Disponibili anche articoli con bracciolo o braccioli fissi senza meccanismo, considerare la dimensione di ingombro in larghezza inferiore.

## TECHNICAL INFORMATION

### Structure: 1-2

Solid spruce and beech wood supports in various thicknesses. Buffer side in class E1 plywood and particleboard panels; details in hard or cellulose wood fibre panels.

### Springing: 1-3

Backrests in hard or cellulose fibreboard panels, and pre-tensioned propylene and latex elastic webbing.

Seat with pre-tensioned crossed propylene fibre and latex elastic webbing.

### Note:

The back has a metal clutch mechanism inside (10) with lifting/lowering function into the desired position. These articles are available also with fixed armrest/armrests without mechanism, in this case consider the lower width overall dimension.

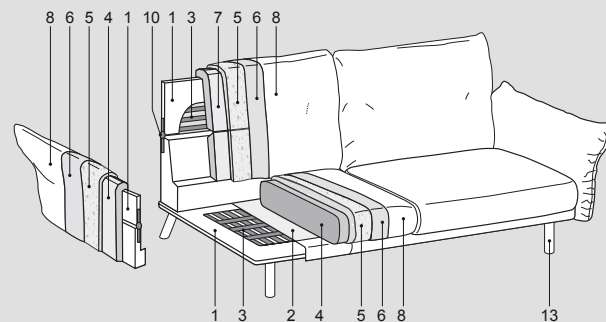
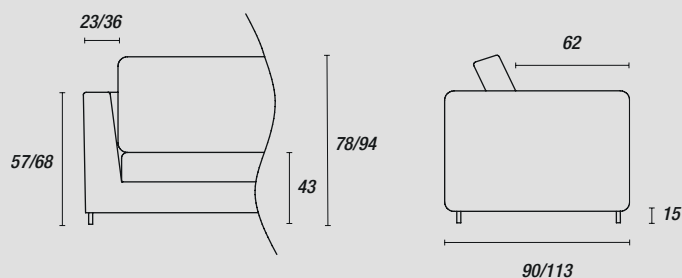

### Piedini - Feet:

#### di serie Plain



H.15cm

Nero (ME09)  
Light brown (ME11)

#### optional Online

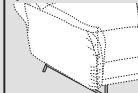

H.15cm

Nero (ME09)  
Light brown (ME11)