

Molteni & C

KENSINGTON — RODOLFO DORDONI 2018

1—
4



Kensington is a relaxing armchair with enveloping lines and calibrated proportions that you can simply sink into when you want to chill out or have a chat with friends. The all-in-one frame, complete with generous armrests, supports an ergonomic seat that guarantees comfort. The central four-spokes is designed to support the slightly sloping frame for greater comfort. Two versions, tall and low, and a practical footrest complete the collection. The Kensington armchair offers a high degree of personalisation, given that the leatherclad outer shell can be combined with the inner frame, also clad in leather, for a refined mono material effect. Alternatively, a pleasing contrast can be obtained by matching the leather-clad shell with an inner frame covered in one of the fabrics from the exclusive Molteni&C collection. With their refined elegance, these elements help to create intimate conversation areas both in the home and in hospitality spaces such as lounges, waiting rooms and executive offices.



This symbol shows that the product has removable upholstery. Only qualified personnel can remove the upholstery of some of our products. If this information is pertinent, it will be included in the warnings section.



This symbol shows that the product is available on request in a fire resistant version that complies with the standards BS 5852 and TB 117-2013. The buyer is responsible for checking to make sure that the product is suitable and compliant with the requirements for the designated use and the current applicable laws and standards for the destination and use of the product.

DATASHEET

REGISTERED
DESIGN

IX.2021

moltenigroup.com

Dimensions in centimeters and inches. The right to discontinue and make changes is reserved. This information is based on the latest product information available at the time of printing.

FINISHES

BASE FINISHES

glossy pewter colour

TECHNICAL INFORMATION

UNDER-SEAT STRUCTURE (ARMCHAIR)

Compact moulded polyurethane, with metal load-bearing structure.

SEAT PADDING (ARMCHAIR)

Compact moulded polyurethane with flexible cold moulded polyurethane foam. Cotton/polyester fibre cover.

BACKREST STRUCTURE (ARMCHAIR)

Metal load-bearing frame with cold-moulded polyurethane foam padding, with cover in cotton/polyester fibre.

UNDER-SEAT STRUCTURE (POUF)

Panel in wooden particle board, with cotton/polyester fibre cover.

SEAT PADDING (POUF)

Panel in wood particle board with flexible cold moulded polyurethane foam. Cotton/polyester fibre cover.

BASE

Laser-cut, welded and painted steel. Feet tips in non-slip plastic.

REMOVABLE OUTER COVER

(See enclosed label, specific for the cover in question).



THE UNDER-SEAT BODY,
ALWAYS UPHOLSTERED IN
LEATHER, IS NOT REMOVABLE



AVAILABLE IN FIRE-RESISTANT
VERSION TB117 AND BS5852

LOW ARMCHAIR



HIGH ARMCHAIRS

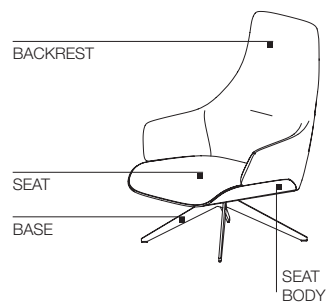

POUF

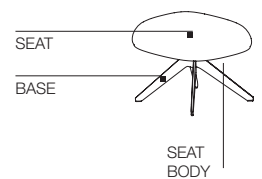

DATASHEET

REGISTERED
DESIGN

IX.2021

NOTES

- ▶ The under-seat body, always upholstered in leather, is not removable.
- ▶ Covers (seat and backrest cushion) can be removed in the fabric and leather versions.
- ▶ In the fabric versions, the underseat shell is always covered in leather; when ordering, specify the category/colour variant of the leather.

Molteni&C

3—
4

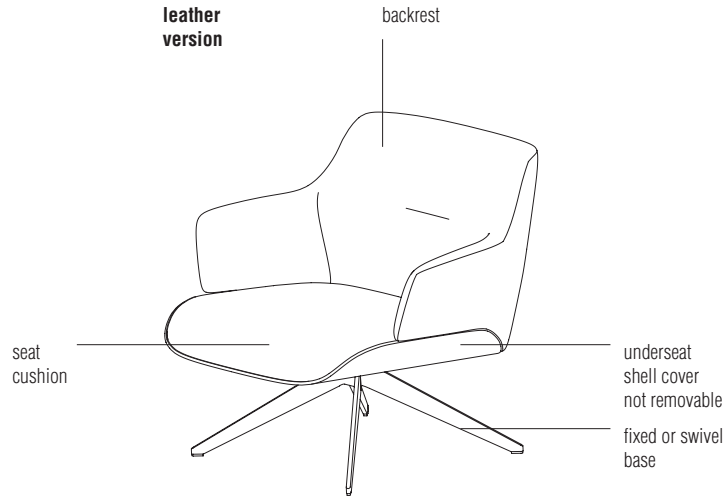

- In leather version, all parts are considered in the same category/colour variant.

- If parts are the same category but different colour variants, consider a surcharge.



DATASHEET

REGISTERED
DESIGN

IX.2021

DIMENSIONS

leather version /
 fabric version

fixed armchair
 with low back

KPB1

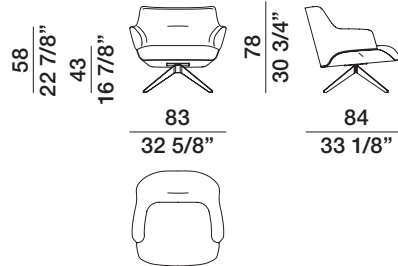

swivel armchair
 with low back

KPB2

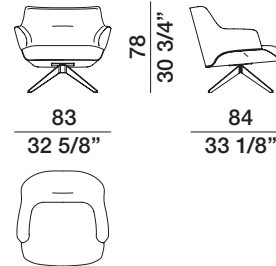

leather version /
 fabric version

fixed armchair
 with high back

KPA1

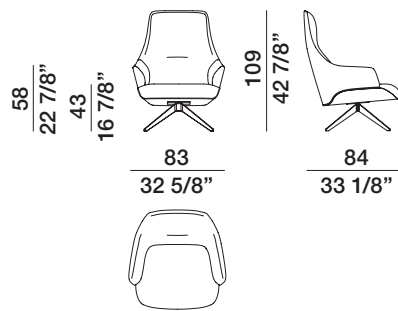

swivel armchair
 with high back

KPA2

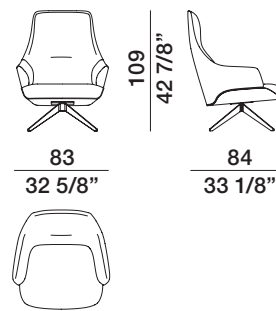

fixed armchair
 with high back

KPA3

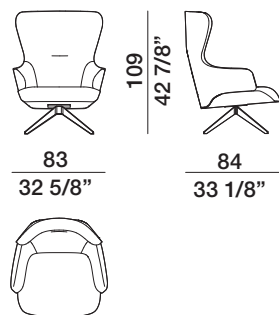

swivel armchair
 with high back

KPA4

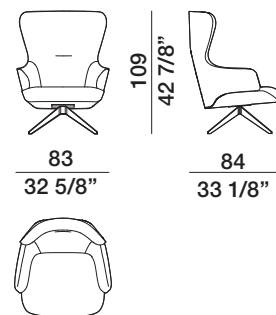

leather version /
 fabric version

pouf

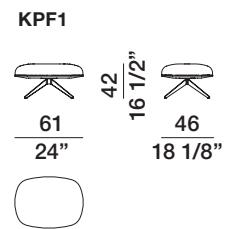

code	gross weight kg.	volume mc.	packages	code	gross weight kg.	volume mc.	packages
KPA1	43	0,827	1	KPB1	40	0,591	1
KPA2	45	0,82	1	KPB2	41,5	0,605	1
KPA3	43	0,827	1	KPF1	38	0,16	1
KPA4	45	0,82	1				

DATASHEET

REGISTERED
 DESIGN

IX.2021