

divano/sofa **Conrad**

elementi/elements

designed by Castello Lagravinese

**Struttura portante:** multistrato, massello di legno.**Imbottiture:** cuscino di schienale in piuma d'oca e fibra di poliestere con inserto in poliuretano espanso rivestito in tela di cotone; cuscino di seduta in poliuretano espanso a densità differenziata rivestito in falda termolegata; scocca in poliuretano espanso a densità differenziata rivestito in resinato accoppiato a vellutino.**Versione standard:** scocca esterna trapuntata.**Versione optional:** scocca esterna senza trapuntatura.**Molleggio:** cinghie elastiche in polipropilene e gomma.**Piedini:** in metallo h. 9 cm.**Main structure:** solid and multilayer wood.**Upholstery:** back cushion in goose feathers and polyester fiber with internal padding in polyurethane foam covered with cotton; seat cushion in polyurethane foam with different densities covered with heat-bonded layer; chassis in polyurethane foam with different densities covered with resinated coupled with velvet.**Standard version:** external chassis with quilting.**Optional version:** external chassis without quilting.**Suspensions:** elastic belts in polypropylen and rubber.**Feet:** in metal, h. 9 cms.

Cod. Tessuto/fabric: 1/01

Cod. Pelle/leather: 2/02

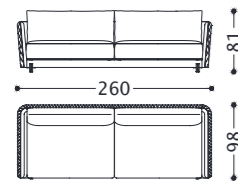
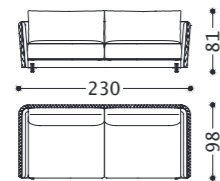
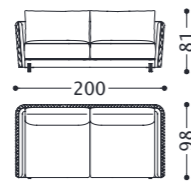
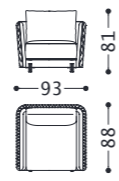
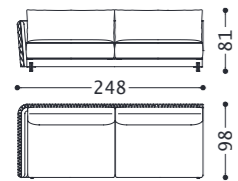
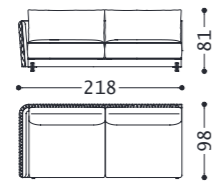
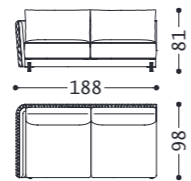
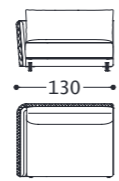
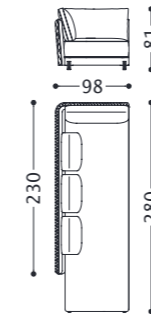
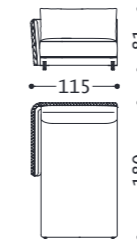
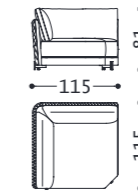
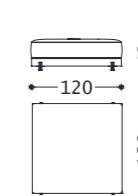
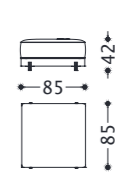
1COND3
2COND31COND2M
2COND2M1COND2
2COND21CONP
2CONP1COND3SX
2COND3SX1COND2MSX
2COND2MSX1COND2SX
2COND2SX1CONE3SX
2CONE3SX1CONMERSX
2CONMERSX1CONCHLSX
2CONCHLSX1CONAAP
2CONAAP1CONPFFQ120
2CONPFFQ1201CONPFFQ85
2CONPFFQ85divano/sofa **Conrad**

composizioni/composition

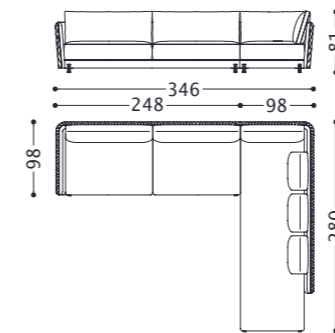
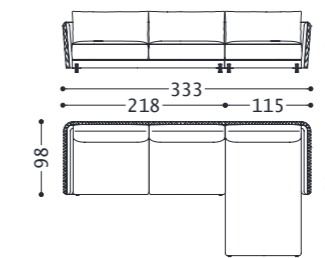
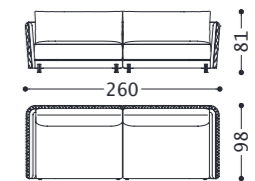
01CONC3
(1COND3SX+1CONMERDX)
02CONC3
(2COND3SX+2CONMERDX)01CONC2
(1COND2MSX+1CONCHLDX)
02CONC2
(2COND2MSX+2CONCHLDX)01CONC1
(1CONE3SX+1CONE3DX)
02CONC1
(2CONE3SX+2CONE3DX)