

FLYNN divano/sofa/canapé/Sofa
 elementi/elements/éléments/Elemente

Design by Maurizio Manzoni



Struttura portante: multistrato, massello di legno.
Imbottiture: cuscino di schienale in piuma d'oca. Cuscino di seduta e scocca in poliuretano espanso a densità differenziata con rivestimento in resinato.
Molle: cinghie elastiche in polipropilene e gomma.
Piedini: in metallo, h. 16 cm.

Main structure: multilayer and solid wood.
Upholstery: backrest cushion in goose feathers. Seat cushion and chassis in polyurethane foam with different densities covered with resinated.
Suspensions: elastic belts in polypropylene and rubber.
Feet: in metal, h. 16 cms.

Structure: multiplis et bois massif.
Rembourrage: coussin de dossier en plume d'oie. Coussin d'assise et chassis en mousse de polyuréthane en plusieurs densités revêtu de résine.
Suspension: sangles élastiques en polypropylène et mousse.
Pieds: en métal, h. 16 cm.

Struktur: vielschichtiges Massivholz.
Polsterung: Rückenlehne aus Gänsedaunen. Sitz und Chassis aus Polyurethanschaum in unterschiedlichen Dichte mit Resinat verkleidet.
Federung: elastische Gurte aus Gummi und Polypropylen.
FüÙe: aus Metall, H. 16 cm.

Cod. Tessuto/fabric/tissu/Stoff: 1/01
 Cod. Pelle/leather/cuir/Leder: 2/02

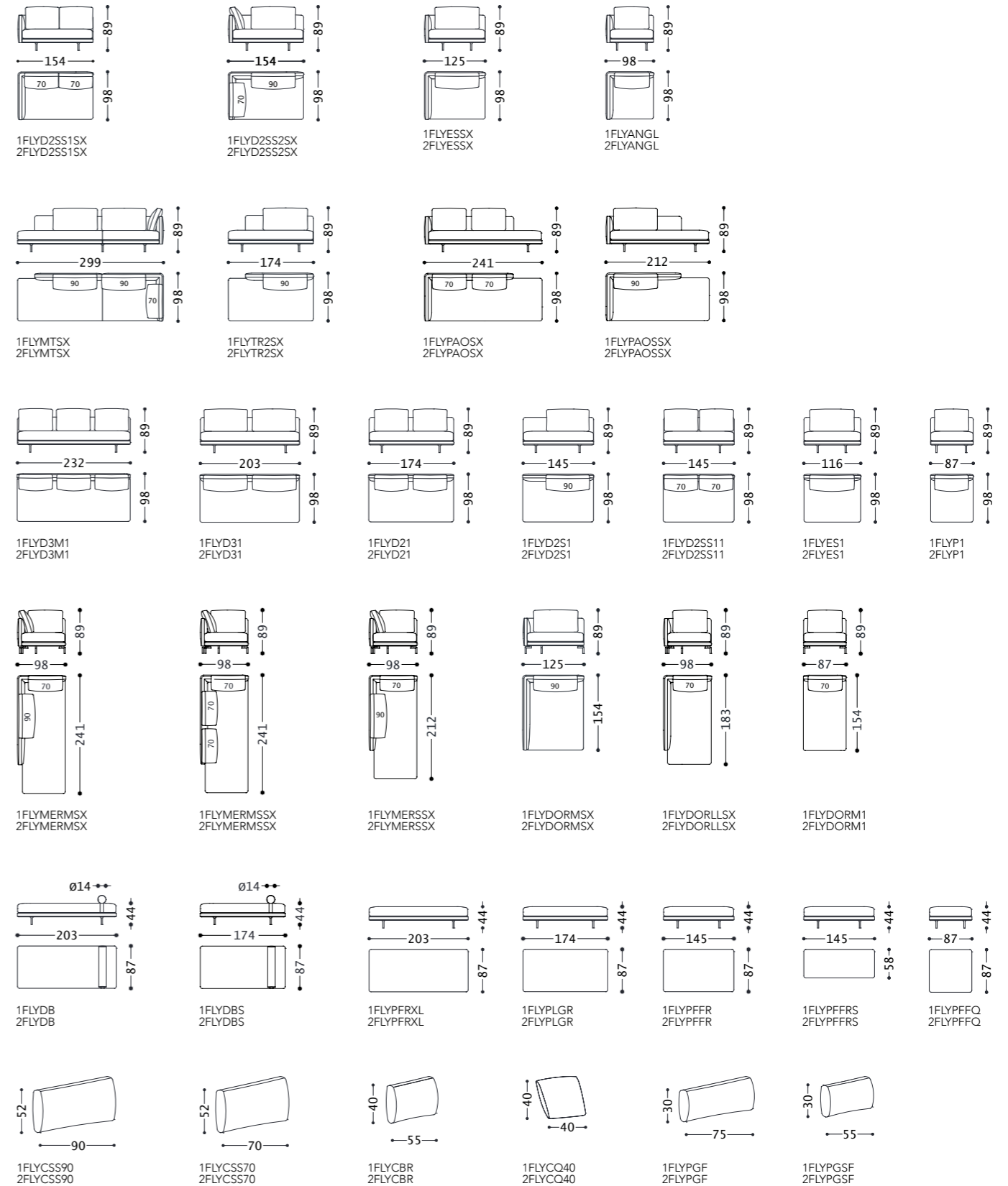
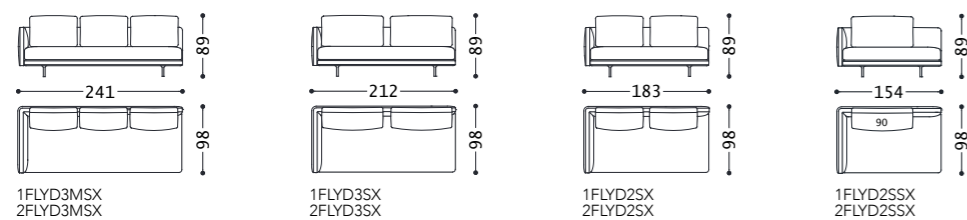
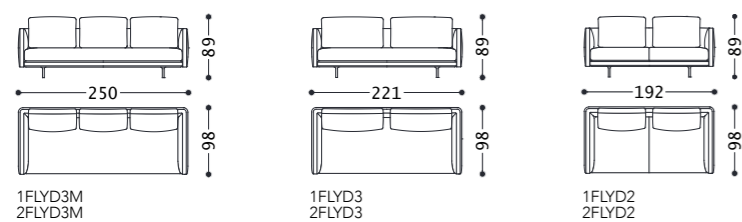
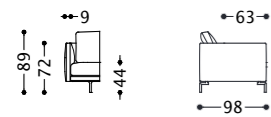

FLYNN divano/sofa/canapé/Sofa

elementi per tavolino/elements for small tables/éléments pour table/Elemente Für Couchtisch

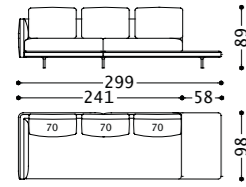

1FLYMTTDX
2FLYMTTDX

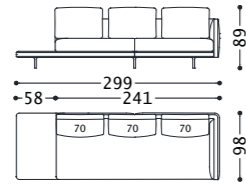

1FLYMTTSX
2FLYMTTSX

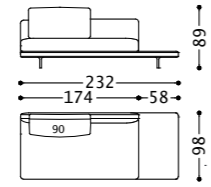

1FLYTR3TDX
2FLYTR3TDX

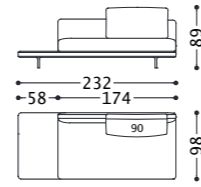

1FLYTR3TSX
2FLYTR3TSX

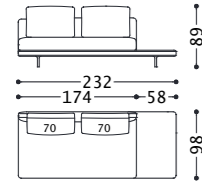

1FLYTR3STDx
2FLYTR3STDx

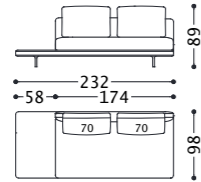

1FLYTR3STsX
2FLYTR3STsX

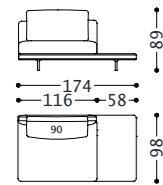

1FLYTR2STDx
2FLYTR2STDx

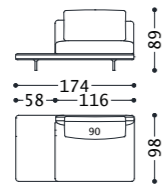

1FLYTR2STsX
2FLYTR2STsX

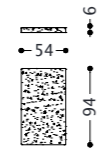

1FYTTAV

FLYNN divano/sofa/canapé/Sofa

composizioni/compositions/Kompositionen

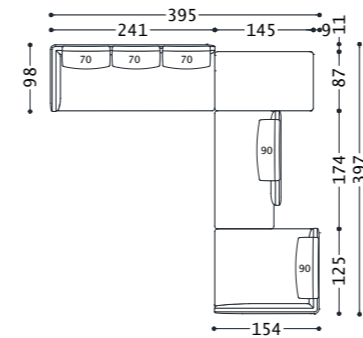

01FLYC1
(1FLYD3MSX+1FLYPFFR+1FLYTR2DX
+1FLYDORMDX)
02FLYC1
(2FLYD3MSX+2FLYPFFR+2FLYTR2DX
+2FLYDORMDX)

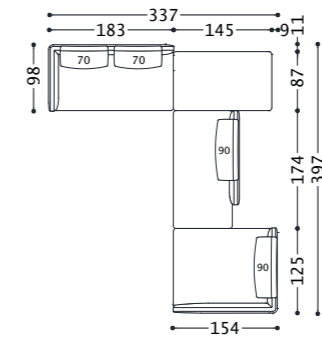

01FLYC2
(1FLYD2SX+1FLYPFFR+1FLYTR2DX
+1FLYDORMDX)
02FLYC2
(2FLYD2SX+2FLYPFFR+2FLYTR2DX
+2FLYDORMDX)

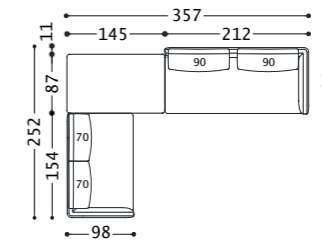

01FLYC27
(1FLYD2SS1SX+1FLYPFFR+1FLYD3DX)
02FLYC27
(2FLYD2SS1SX+2FLYPFFR+2FLYD3DX)

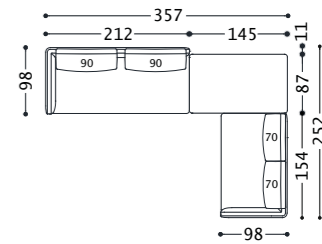

01FLYC28
(1FLYD3SX+1FLYPFFR+1FLYD2SS1DX)
02FLYC28
(2FLYD3SX+2FLYPFFR+2FLYD2SS1DX)

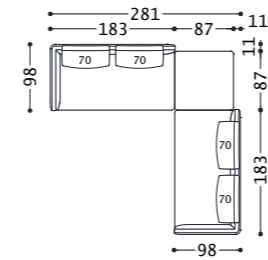

01FLYC9
(1FLYD2SX+1FLYPFFQ+1FLYD2DX)
02FLYC9
(2FLYD2SX+2FLYPFFQ+2FLYD2DX)

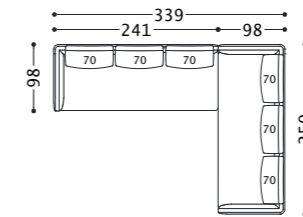

01FLYC8
(1FLYD3MSX+1FLYD3M)
02FLYC8
(2FLYD3MSX+2FLYD3M)

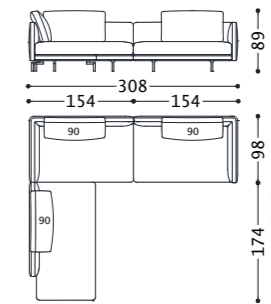

01FLYC3
(1FLYTR2SX+1FLYD2SSX+1FLYD2SDX)
02FLYC3
(2FLYTR2SX+2FLYD2SSX+2FLYD2SDX)

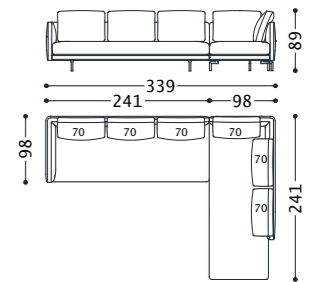

01FLYC5
(1FLYD3MSX+1FLYMERMSDX)
02FLYC5
(2FLYD3MSX+2FLYMERMSDX)

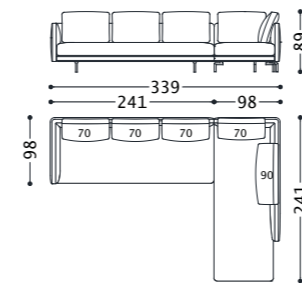

01FLYC6
(1FLYD3MSX+1FLYMERMSDX)
02FLYC6
(2FLYD3MSX+2FLYMERMSDX)

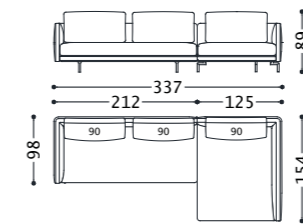

01FLYC4
(1FLYD3SX+1FLYDORMDX)
02FLYC4
(2FLYD3SX+2FLYDORMDX)

FLYNN divano/sofa/canapé/Sofa

composizioni con tavolino/compositions with small tables/compositions avec table/Kompositionen mit Couchtisch

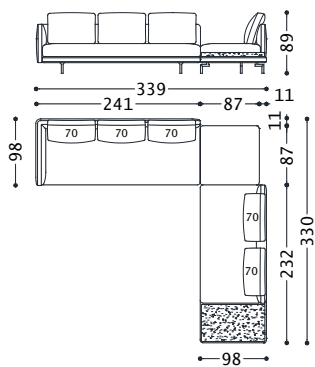

03FLYC24
(1FLYD3MSX+1FLYPFFQ+1FLYTR3STDx+1FYTTAV)
03FLYC25
(2FLYD3MSX+2FLYPFFQ+2FLYTR3STDx+1FYTTAV)

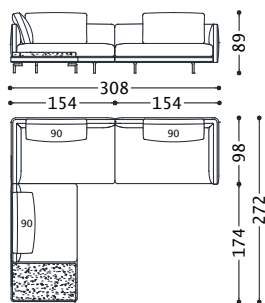

03FLYC20
(1FLYTR2STSX+1FYTTAV+1FLYD2SSX+1FLYD2SDX)
03FLYC21
(2FLYTR2STSX+1FYTTAV+2FLYD2SSX+2FLYD2SDX)

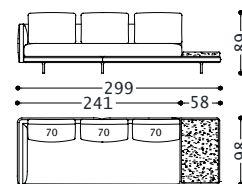

03FLYC11
(1FLYMTTDX+1FYTTAV)
03FLYC10
(2FLYMTTDX+1FYTTAV)

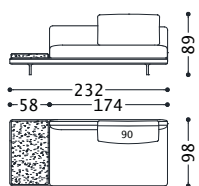

03FLYC15
(1FLYTR3TSX+1FYTTAV)
03FLYC18
(2FLYTR3TSX+1FYTTAV)

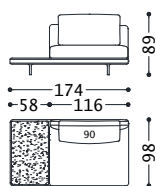

03FLYC14
(1FLYTR2STSX+1FYTTAV)
03FLYC17
(2FLYTR2STSX+1FYTTAV)