

LAGUNA divano/sofa/canapé/Sofa

elementi/elements/éléments/Elemente

designed by Castello Lagravinese Studio



Struttura portante: Multistrato, massello di legno.

Imbottiture: Cuscino di schienale in piuma d'oca e fibra di poliestere con inserto in poliuretano espanso (densità 21 kg/mc) rivestito in tela di cotone. Secondo cuscino di schienale (elementi profondi) in piuma d'oca e fibra di poliestere rivestito in tela di cotone/poliestere. Cuscino di seduta in piuma d'oca e fibra di poliestere con inserto in poliuretano espanso a densità differenziata, rivestito in tela di cotone/poliestere. Scocca in poliuretano espanso a densità differenziata rivestita in resinato accoppiato a vellutino.

Molle: Cinghie elastiche in polipropilene e gomma.

Piedino: ABS, h. 4 cm.

Main structure: Multilayer and solid wood.

Upholstery: Backrest in goose feathers and polyester fiber with internal padding in polyurethane foam (density 21 kg/mc) covered with cotton fabric. Second backrest cushion (deep elements) in goose feathers and polyester fiber covered with cotton fabric/polyster. Seat cushion in goose feathers and polyester fiber with internal padding in polyurethane foam with different densities, covered with cotton fabric/polyster. Chassis in polyurethane foam with different densities covered with resinat coupled with velvet.

Suspensions: Elastic belts in polypropylene and rubber.

Feet: ABS, h. 4 cms.

Structure: Multiplis, bois massif.

Rembourrage: Coussins de dossier en plumes d'oie et fibre de polyéster avec insert en mousse de polyuréthane (densité 21 Kg/mc) sous housse de coton. Deuxième coussin de dossier (éléments profonds) en plumes d'oie et fibre de polyéster sous housse de coton/polyéster. Coussin d'assise en plumes d'oie et fibre de polyéster avec insert en mousse de polyuréthane à densités différentes, sous housse de coton/polyéster. Chassis en mousse de polyuréthane à densités différentes revêtu de résine accouplé avec velveteen.

Suspension: Sangles élastiques en polypropylène et mousse.

Pieds: ABS, h. 4 cm.

Hauptstruktur: vielschichtiges Massivholz.

Polsterung: Rückenkissen aus Gänsedaunen und Polyesterfaser mit Einsatz aus Polyurethanschaum (Dichte 21 Kg/mc) mit Baumwolle bedeckt. Zweiter Rückenkissen (tiefe Elemente) aus Gänsedaunen und Polyesterfaser mit Baumwolle-Polyesterstoffe bedeckt. Sitzkissen aus Gänsedaunen und Polyesterfaser mit Einsatz aus Polyurethanschaum in unterschiedlichen Dichten und mit Baumwolle-Polyesterstoffe bedeckt. Chassis aus Polyurethanschaum mit unterschiedlicher Dichte mit gekoppeltem Samt und Resinat verkleidet.

Federung: Elastische Gurte aus Gummi und Polypropylen.

Füße: ABS, h. 4 cm.

Cod. Tessuto/fabric/tissu/Stoff: 1/01

Cod. Pelle/leather/cuir/Leder: 2/02

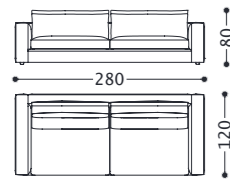
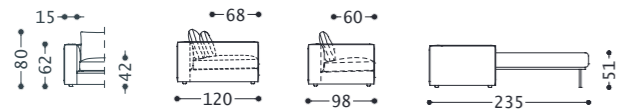

1LAGD3MPR
2LAGD3MPR

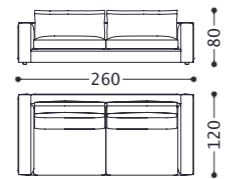

1LAGD3PR
2LAGD3PR

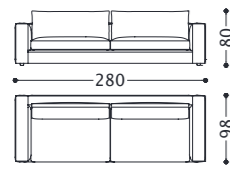

1LAGD3M
2LAGD3M

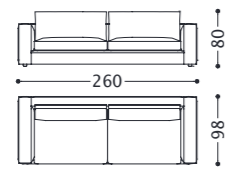

1LAGD3
2LAGD3

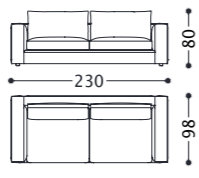

1LAGD2M
2LAGD2M

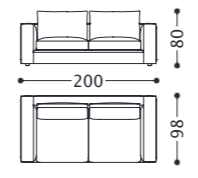

1LAGD2
2LAGD2

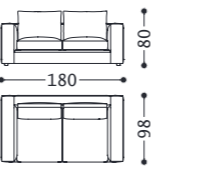

1LAGD2S
2LAGD2S

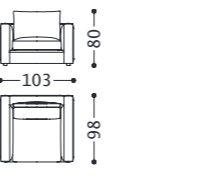

1LAGP
2LAGP

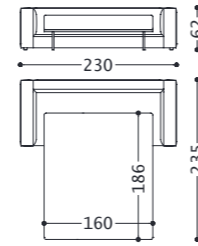

1LAGD2MSPP
2LAGD2MSPP

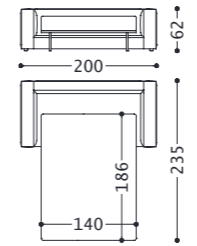

1LAGD2SPP
2LAGD2SPP

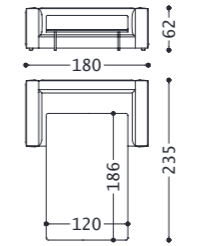

1LAGD2SSPP
2LAGD2SSPP

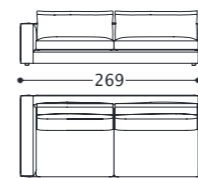

1LAGD3MPRSX
2LAGD3MPRSX

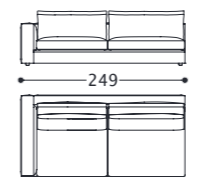

1LAGD3PRSX
2LAGD3PRSX

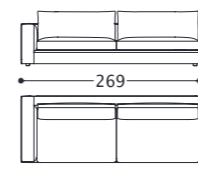

1LAGD3MSX
2LAGD3MSX

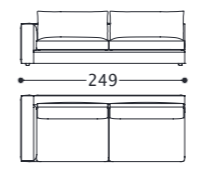

1LAGD3SX
2LAGD3SX

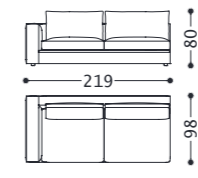

1LAGD2MSX
2LAGD2MSX

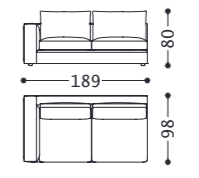

1LAGD2SX
2LAGD2SX

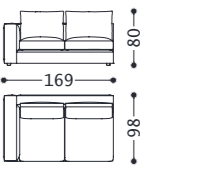

1LAGD2SSX
2LAGD2SSX

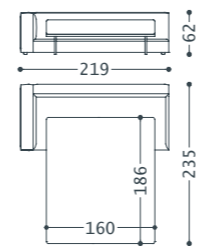

1LAGD2MSXSPP
2LAGD2MSXSPP

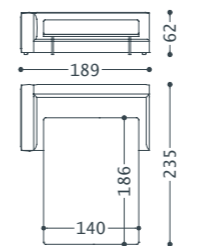

1LAGD2XSPP
1LAGD2XSPP

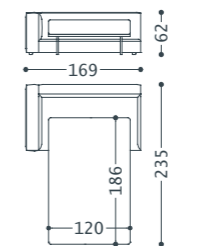

1LAGD2SSXSPP
2LAGD2SSXSPP

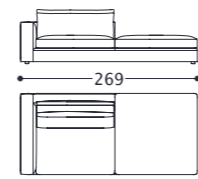

1LAGTR3MPRSX
2LAGTR3MPRSX

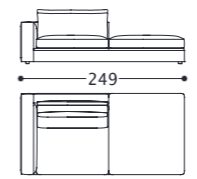

1LAGTR3PRSX
2LAGTR3PRSX

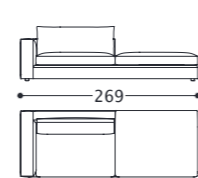

1LAGTR3MSX
2LAGTR3MSX

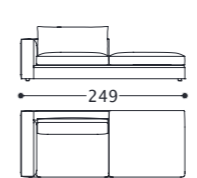

1LAGTR3SX
2LAGTR3SX

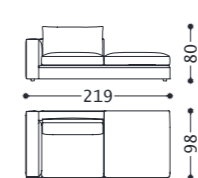

1LAGTR2MSX
2LAGTR2MSX

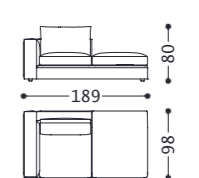

1LAGTR2SX
2LAGTR2SX

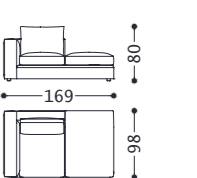

1LAGTR2SSX
2LAGTR2SSX



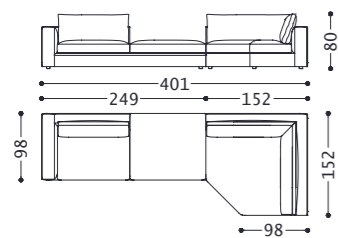

01LAGC1
 (1LAGTR3SX + 1LAGTRSP)
 02LAGC1
 (2LAGTR3SX + 2LAGTRSP)

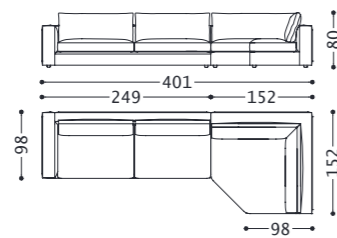

01LAGC10
 (1LAGD3SX + 1LAGTRSP)
 02LAGC10
 (2LAGD3SX + 2LAGTRSP)

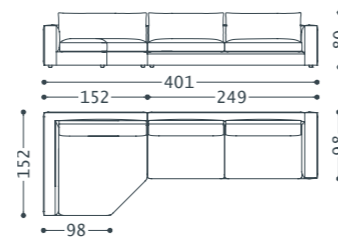

01LAGC17
 (1LAGTRSPSC + 1LAGD3DX)
 02LAGC17
 (2LAGTRSPSC + 2LAGD3DX)

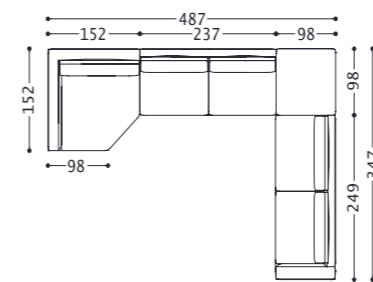

01LAGC18
 (1LAGTRSPSC + 1LAGD31 + 1LAGPFFQ + 1LAGD3DX)
 02LAGC18
 (2LAGTRSPSC + 2LAGD31 + 2LAGPFFQ + 2LAGD3DX)

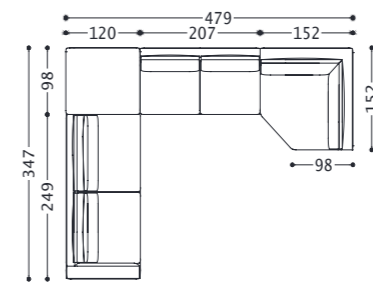

01LAGC14
 (1LAGD3PRSX + 1LAGPFFR + 1LAGD2M1 + 1LAGTRSP)
 02LAGC14
 (2LAGD3PRSX + 2LAGPFFR + 2LAGD2M1 + 1LAGTRSP)

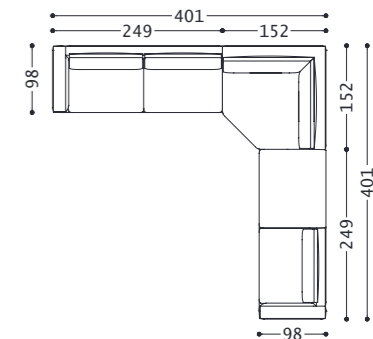

01LAGC6
 (1LAGD3SX + 1LAGTRSP + 1LAGTR3DX)
 02LAGC6
 (2LAGD3SX + 2LAGTRSP + 2LAGTR3DX)

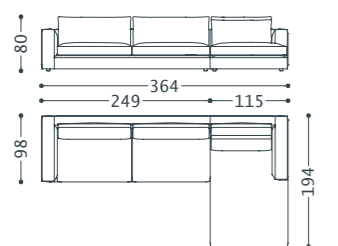

01LAGC2
 (1LAGD3SX + 1LAGCHLMDX)
 02LAGC2
 (2LAGD3SX + 2LAGCHLMDX)

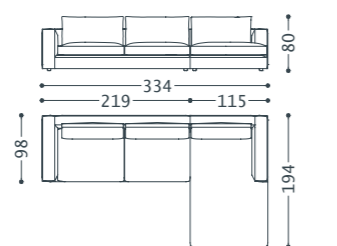

01LAGC8
 (1LAGD2MSX + 1LAGCHLMDX)
 02LAGC8
 (2LAGD2MSX + 2LAGCHLMDX)

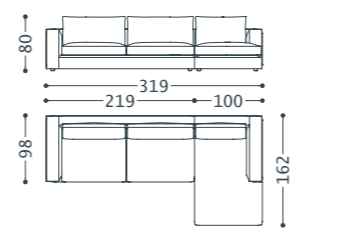

01LAGC4
 (1LAGD2MSX + 1LAGCHLDX)
 02LAGC4
 (2LAGD2MSX + 2LAGCHLDX)

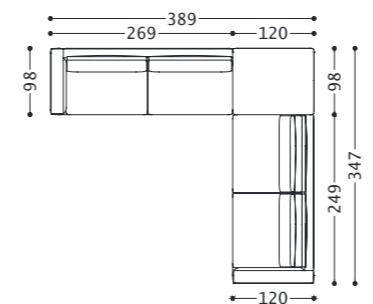

01LAGC5
 (1LAGD3MSX + 1LAGPFFR + 1LAGD3PRDX)
 02LAGC5
 (2LAGD3MSX + 2LAGPFFR + 2LAGD3PRDX)

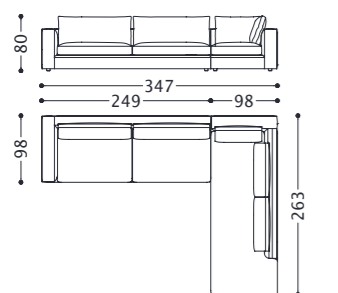

01LAGC3
 (1LAGD3SX + 1LAGMERDX)
 02LAGC3
 (2LAGD3SX + 2LAGMERDX)

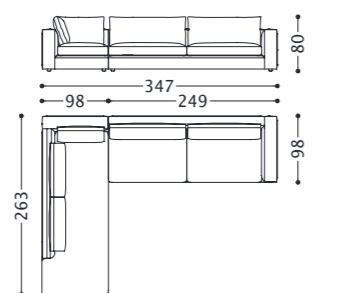

01LAGC9
 (1LAGMERSX + 1LAGD3DX)
 02LAGC9
 (2LAGMERSX + 2LAGD3DX)

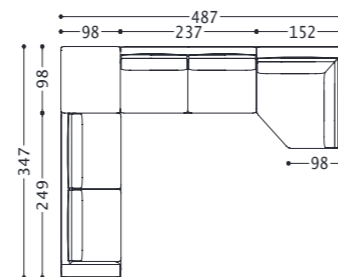

01LAGC11
 (1LAGD3SX + 1LAGPFFQ + 1LAGD31 + 1LAGTRSP)
 02LAGC11
 (2LAGD3SX + 2LAGPFFQ + 2LAGD31 + 2LAGTRSP)