











Eclético Comfort low narrow armrest

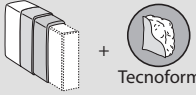

Eclético Comfort bracciolo largo basso

	Seat - Assise	Backrests - Dossiers	Structure - Structure	
Upholstering Revetement (9)	Removable <i>Déhoussable</i>	 	 	
	Not removable <i>Non déhoussable</i>	—	—	
Padding Rembourrages (2-4-5-6-7-8)	 D.35kg/m ³		 D.30kg/m ³	 optional

TECHNICAL INFORMATION

Structure: 1

Supporting structure in pinewood of various thicknesses. Remaining parts in class E1 particleboard panels, hardboard or cellulose wood-based panels details.

Springing: 1-3

The back is made of hard or cellulose wooden fibre panels.
The seat is supported by propylene and latex elastic belts.

Note:

Smooth upper seat cushions down covered, in quilted version covered by Tecnoform.

For technical reasons the modular elements can have the base completely upholstered on the modular side only upon request, without surcharge.

List price for sofa with low backrest "B"; add on a fabric surcharge for a fabric sofa with high backrest "A" or add on a leather surcharge for a leather sofa with high backrest "A".
Take note of the different end heights of low backrest "B" and high backrest "A".

INFORMATIONS TECHNIQUES

Structure: 1

Structure porteuse en bois de pin de différentes épaisseurs. Autres parties en panneaux de particules de bois en classe E1, détails en panneaux de fibre de bois dure ou cellulose.

Suspension: 1-3

Dossier en panneaux de fibre de bois dure ou cellulose.
Assise avec sangles élastiques de fibre propylénique et latex.

Note:

Coussins au-dessus de l'assise lisses recouverts de duvet, en version matelassée recouverte de Tecnoform.

Pour des raisons techniques, les éléments modulaires peuvent avoir la base entièrement revêtue dans le côté modulaire uniquement sur demande, sans supplément.

Prix appliqués pour le canapé avec dossier bas « B » ; ajouter un supplément en tissu pour obtenir le canapé en tissu avec dossier haut « A » ou ajouter un supplément en cuir pour obtenir le canapé en cuir avec dossier haut « A ». Prêter attention à la différence de hauteur finale entre le dossier bas « B » et le dossier haut « A ».

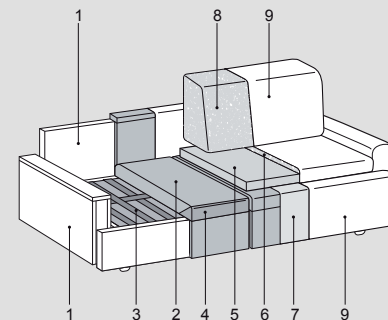
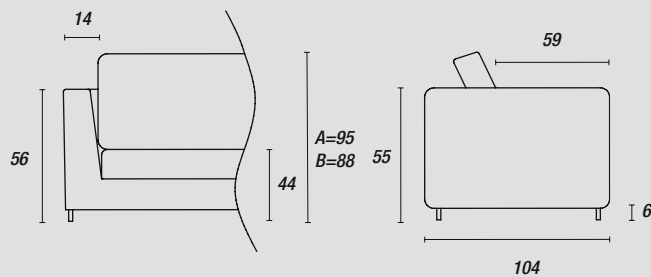

Feet - Pieds::

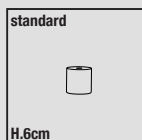











Black (ME09)

Eclético Comfort high narrow armrest

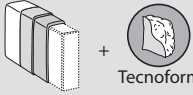

Eclético Comfort bracciolo largo basso

	Seat - Assise	Backrests - Dossiers	Structure - Structure	
Upholstering Revetement (9)	Removable Déhoussable	 	 	
	Not removable Non déhoussable	—	—	
Padding Rembourrages (2-4-5-6-7-8)	 D.35kg/m³		 D.30kg/m³	 optional

TECHNICAL INFORMATION

Structure: 1

Supporting structure in pinewood of various thicknesses. Remaining parts in class E1 particleboard panels, hardboard or cellulose wood-based panels details.

Springing: 1-3

The back is made of hard or cellulose wooden fibre panels.
The seat is supported by propylene and latex elastic belts.

Note:

Smooth upper seat cushions down covered, in quilted version covered by Tecnoform.

For technical reasons the modular elements can have the base completely upholstered on the modular side only upon request, without surcharge.

List price for sofa with low backrest "B"; add on a fabric surcharge for a fabric sofa with high backrest "A" or add on a leather surcharge for a leather sofa with high backrest "A". Take note of the different end heights of low backrest "B" and high backrest "A".

INFORMATIONS TECHNIQUES

Structure: 1

Structure porteuse en bois de pin de différentes épaisseurs. Autres parties en panneaux de particules de bois en classe E1, détails en panneaux de fibre de bois dure ou cellulose.

Suspension: 1-3

Dossier en panneaux de fibre de bois dure ou cellulose.
Assise avec sangles élastiques de fibre propylénique et latex.

Note:

Coussins au-dessus de l'assise lisses recouverts de duvet, en version matelassée recouverte de Tecnoform.

Pour des raisons techniques, les éléments modulaires peuvent avoir la base entièrement revêtue dans le côté modulaire uniquement sur demande, sans supplément.

Prix appliqués pour le canapé avec dossier bas « B » ; ajouter un supplément en tissu pour obtenir le canapé en tissu avec dossier haut « A » ou ajouter un supplément en cuir pour obtenir le canapé en cuir avec dossier haut « A ». Prêter attention à la différence de hauteur finale entre le dossier bas « B » et le dossier haut « A ».

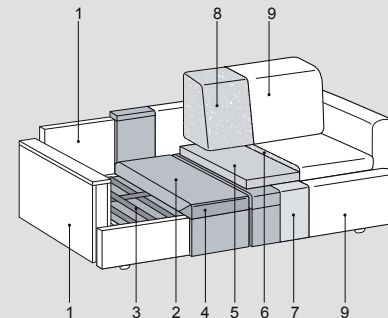
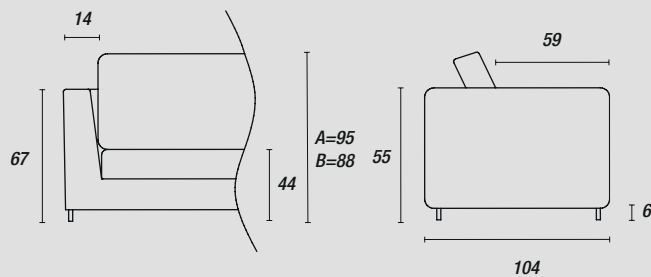

Feet - Pieds::

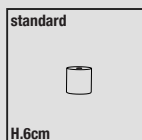











Black (ME09)

Eclético Comfort low wide armrest

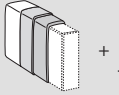

Eclético Comfort bracciolo largo basso

	Seat - Assise	Backrests - Dossiers	Structure - Structure	
Upholstering Revetement (9)	Removable Déhoussable	 	 	
	Not removable Non déhoussable	—	—	
Padding Rembourrages (2-4-5-6-7-8)	 +  D.35kg/m ³		 +  D.30kg/m ³	 optional

TECHNICAL INFORMATION

Structure: 1

Supporting structure in pinewood of various thicknesses. Remaining parts in class E1 particleboard panels, hardboard or cellulose wood-based panels details.

Springing: 1-3

The back is made of hard or cellulose wooden fibre panels.
The seat is supported by propylene and latex elastic belts.

Note:

Smooth upper seat cushions down covered, in quilted version covered by Tecnoform.

For technical reasons the modular elements can have the base completely upholstered on the modular side only upon request, without surcharge.

List price for sofa with low backrest "B"; add on a fabric surcharge for a fabric sofa with high backrest "A" or add on a leather surcharge for a leather sofa with high backrest "A". Take note of the different end heights of low backrest "B" and high backrest "A".

INFORMATIONS TECHNIQUES

Structure: 1

Structure porteuse en bois de pin de différentes épaisseurs. Autres parties en panneaux de particules de bois en classe E1, détails en panneaux de fibre de bois dure ou cellulose.

Suspension: 1-3

Dossier en panneaux de fibre de bois dure ou cellulose.
Assise avec sangles élastiques de fibre propylénique et latex.

Note:

Coussins au-dessus de l'assise lisses recouverts de duvet, en version matelassée recouverte de Tecnoform.

Pour des raisons techniques, les éléments modulaires peuvent avoir la base entièrement revêtue dans le côté modulaire uniquement sur demande, sans supplément.

Prix appliqués pour le canapé avec dossier bas « B » ; ajouter un supplément en tissu pour obtenir le canapé en tissu avec dossier haut « A » ou ajouter un supplément en cuir pour obtenir le canapé en cuir avec dossier haut « A ». Prêter attention à la différence de hauteur finale entre le dossier bas « B » et le dossier haut « A ».

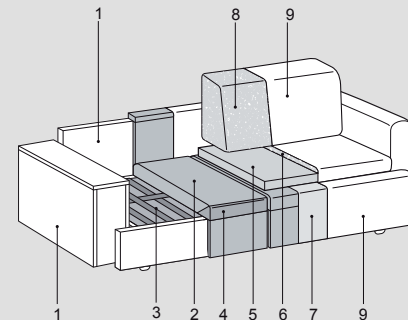
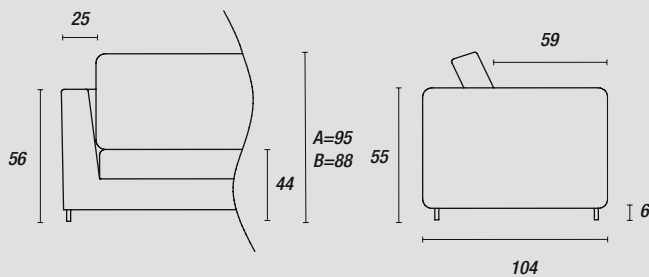

Feet - Pieds::

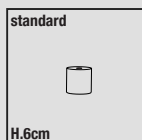

Black (ME09)