











Skin

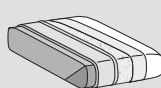

| | Seat - Assise | Backrests - Dossiers | Base - Base | |
|-----------------------------------------------------------|-----------------------------------------------------------------------------------------------------------------------------------------------------------------------------------------|---------------------------------------------------------------------------------------------------------------------------------------------------------------------|-----------------------------------------------------------------------------------------------------|---------------------------------------------------------------------------------------------------|
| Upholstering <i>Revetement</i> (11) | Removable <i>Déhoussable</i> |   |  |  |
| | Not removable <i>Non déhoussable</i> | — |  |  |
| Padding <i>Rembourrages</i> (4-5-6-7-8-9-10) |   D.35/40kg/m³ |  D.25kg/m³ |  Interliner |  optional |

TECHNICAL INFORMATION

Structure: 1-2

Supporting frame in class E1 plywood panels, solid spruce and beech wood supports in various thicknesses. Buffer sides in grade E1 plywood and particleboard panels; details in hardwood or cellulose fibreboard panels. Curved plywood armrest.

Springing: 1-3

Backrest with pre-tensioned elastic strips in propylene fibre and latex. Seat with pre-tensioned crossed propylene fibre and latex elastic webbing.

Note:

Armrest panel cover non removable
Metal varnished Skin small table

INFORMATIONS TECHNIQUES

Structure: 1-2

Châssis en panneaux de contreplaqué de bois classe E1 et supports massifs de bois d'apicéa ou de hêtre, de différentes épaisseurs. Côtés de compensation en panneaux de bois multiplis et particules de bois de classe E1, détails en panneaux de fibre de bois dur ou cellulose. Accoudoir en bois multiplis arrondi.

Suspension: 1-3

Dossier en rubans élastiques de fibre propylène et latex mécaniquement pré-tensionnés. Assise en rubans élastique de fibre propylène et latex croisés et mécaniquement pré-tensionnés.

Note:

Panneau accoudoir non déhoussable
Table de salon Skin en métal verni

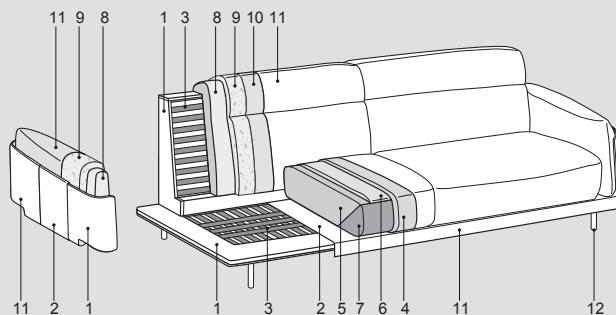
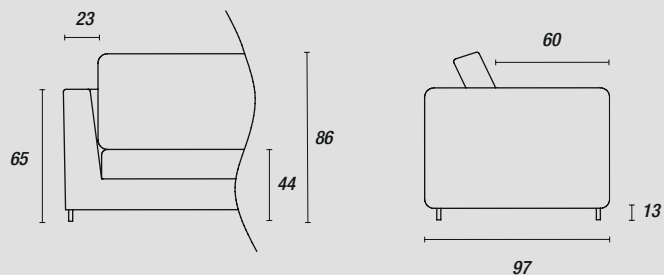

Feet - Pieds::

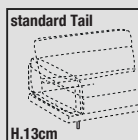

Black (ME09)
Light brown (ME11)



at a surcharge
Black (ME09)
Light brown (ME11)

Accessories - Accessoires:

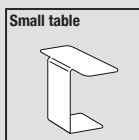



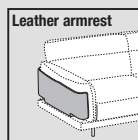



Black (ME09)
Light brown (ME11)

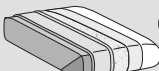

Skin mix



| | Seat - Assise | Backrests - Dossiers | Base - Base | |
|-----------------------------------------------------------|-----------------------------------------------------------------------------------------------------|----------------------------------------------------------------------------------------------------------------|--------------------------------------------------------------------------------------------------|-----------------------------------------------------------------------------------------------------|
| Upholstering <i>Revetement</i> (11) | Removable <i>Déhoussable</i> |  |  | - |
| | Not removable <i>Non déhoussable</i> | - | - |  |
| Padding <i>Rembourrages</i> (4-5-6-7-8-9-10) |  D.35/40kg/m³ |  memory foam & Tecnoform |  D.25kg/m³ |  Interliner |
| |  optional | | | |

TECHNICAL INFORMATION

Structure: 1-2

Supporting frame in class E1 plywood panels, solid spruce and beech wood supports in various thicknesses. Buffer sides in grade E1 plywood and particleboard panels; details in hardwood or cellulose fibreboard panels. Curved plywood armrest.

Springing: 1-3

Backrest with pre-tensioned elastic strips in propylene fibre and latex. Seat with pre-tensioned crossed propylene fibre and latex elastic webbing.

Note:

Armrest panel cover non removable
Metal varnished Skin small table

INFORMATIONS TECHNIQUES

Structure: 1-2

Châssis en panneaux de contreplaqué de bois classe E1 et supports massifs de bois d'apicéa ou de hêtre, de différentes épaisseurs. Côtés de compensation en panneaux de bois multiplis et particules de bois de classe E1, détails en panneaux de fibre de bois dur ou cellulose. Accoudoir en bois multiplis arrondi.

Suspension: 1-3

Dossier en rubans élastiques de fibre propylène et latex mécaniquement pré-tensionnés. Assise en rubans élastique de fibre propylène et latex croisés et mécaniquement pré-tensionnés.

Note:

Panneau accoudoir non déhoussable
Table de salon Skin en métal verni

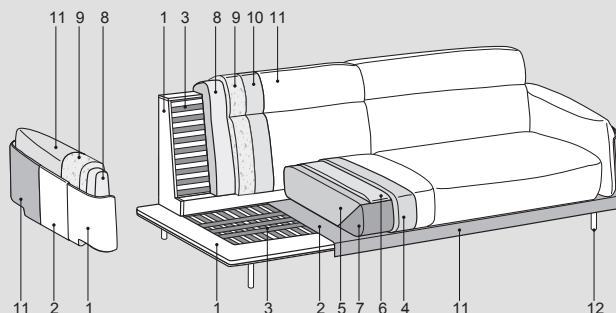
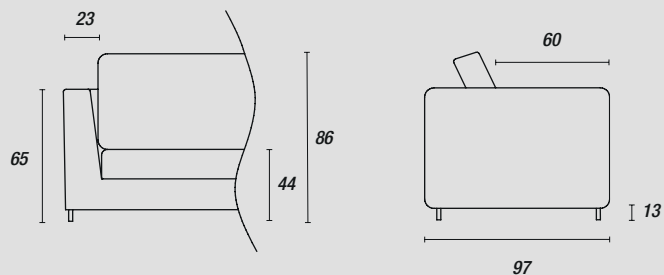

Feet - Pieds::

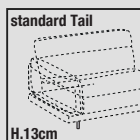

Black (ME09)
Light brown (ME11)



at a surcharge
Black (ME09)
Light brown (ME11)

Accessories - Accessoires:

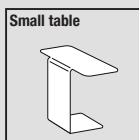

Black (ME09)
Light brown (ME11)