

M027 - MANZONI BIG

FRONTALE
FRONT

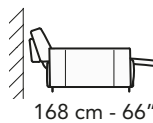

LATERALE
DEPTH

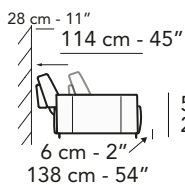
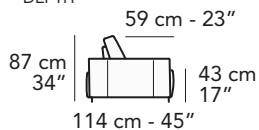

A

B 1202

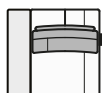

122 cm - 48"

1203



91 cm - 36"

B 1201

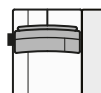

122 cm - 48"

1931

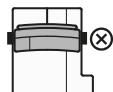

107 cm - 42"

8135



30 cm - 12"

1932

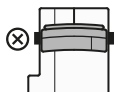

107 cm - 42"

B 1942

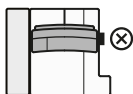

137 cm - 54"

8135



30 cm - 12"

B 1941

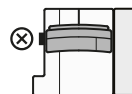

137 cm - 54"

B 1162

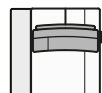

122 cm - 48"

1163



91 cm - 36"

B 1161

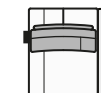

122 cm - 48"

B 5202

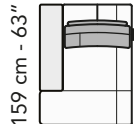

122 cm - 48"

5203

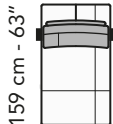

91 cm - 36"

B 5201

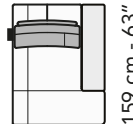

122 cm - 48"

tutti gli elementi del gruppo A hanno lo stesso modulo di seduta - all items in group A have the same seat width

B

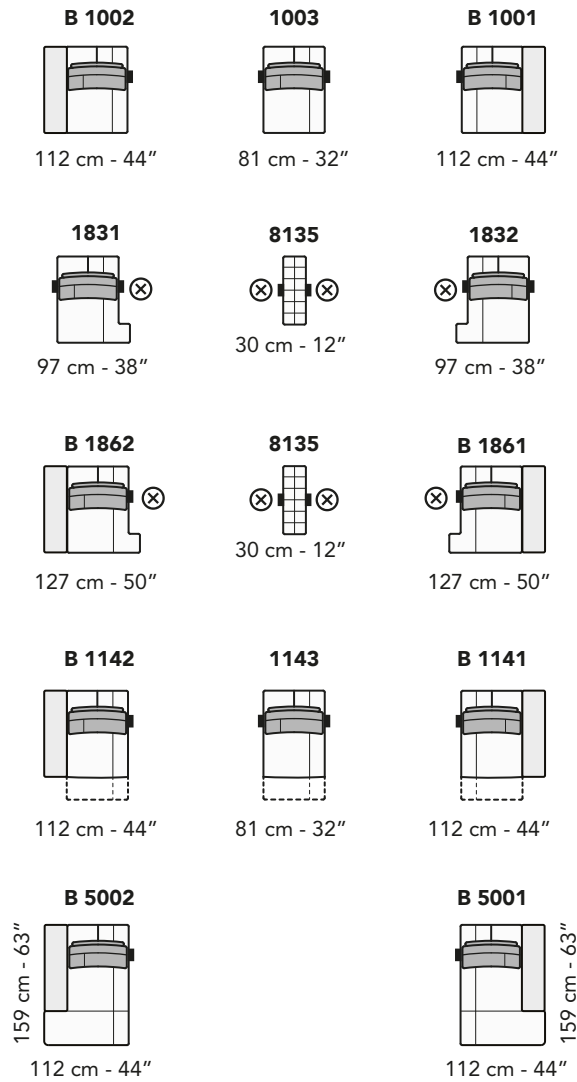

tutti gli elementi del gruppo B hanno lo stesso modulo di seduta - all items in group B have the same seat width

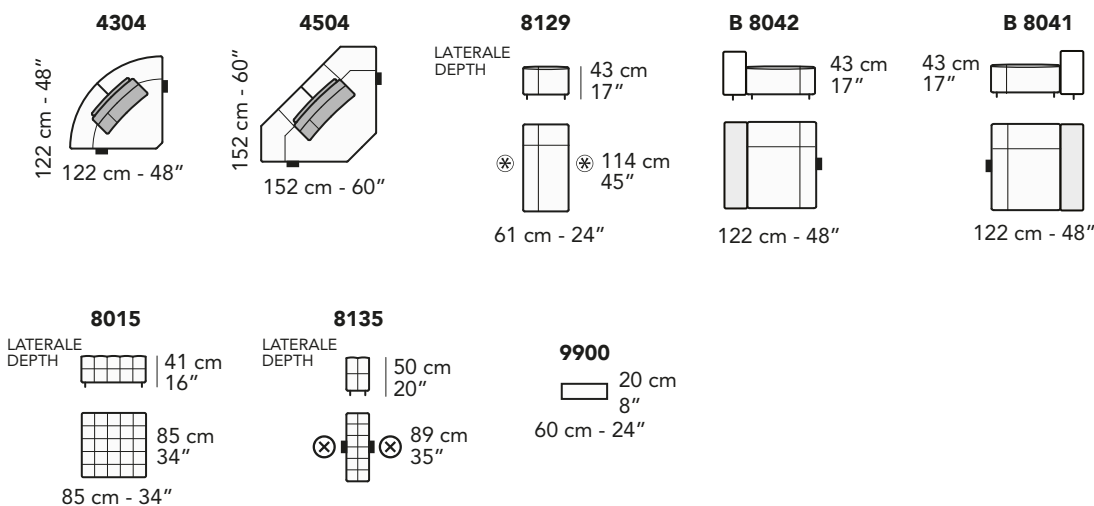

Scala 1:100
Ratio 1 to 100

Legenda / Legend

■ Spalliera / Back Cushions ■ Bracciolo / Armrest
 ■ Poggiareni / Kidneyrest □ Seduta / Seat Cushions

⊗ Lato terminale sempre rifinito e agganciabile agli elementi componibili / Terminal side is always finished and it can also be connected to modular elements

■ Aggancio Componibile / Connector
 ⊗ Lato agganciabile obbligatoriamente con la versione 8135/ Side that can only be connected with version 8135

COMPOSIZIONI CONSIGLIATE

SUGGESTED COMPOSITIONS

B1202 + 1203 + B5201

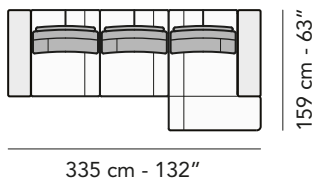

B1202 + 1203 + 4504 + 1203 + 8129

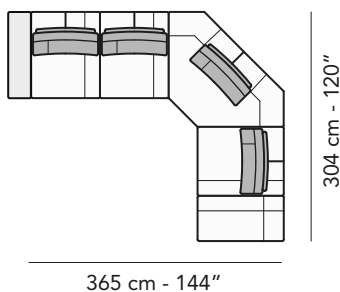

B8042 + 1203 + 4304 + 1203 + B1201

