

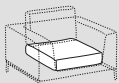





# 356 woven outdoor



	 Seat - Assise	 Backrest - Dossier	
<b>Upholstering</b> <i>Revetement</i> (8)	Removable <i>Déhoussable</i> 	Removable <i>Déhoussable</i> 	
	Not removable <i>Non déhoussable</i> —	Not removable <i>Non déhoussable</i> —	
<b>Padding</b> <i>Rembourrages</i> (5-6-7)	 D.30kg/m³	 D.18kg/m³	

## TECHNICAL INFORMATION

### Structure: 1-2-3

Structure in plywood panels and solid load-bearing in okume' of various thicknesses.

### Springing: 2-3-4

Tubular backrest in painted metal with outdoor treatment and braided rope. The seat is supported by propylene and latex elastic belts.

### Notes:

Pre-lining in breathable water-repellent material.  
Heat-sealed water-repellent cover available upon request (for technical specifications see Materials, Finishes and Warnings page).

## INFORMATIONS TECHNIQUES

### Structure: 1-2-3

Structure en panneaux de bois lattés multicouches et blocs de support en okume' de différentes épaisseurs.

### Suspension: 2-3-4

Dossier tubulaire en métal peint avec traitement extérieur et corde tressée. Assise avec sangles élastiques de fibre propylénique et latex.

### Note:

Pré-doublure en matière respirante et déperlante.  
Disponible sur demande housse hydrofuge thermosoudée (pour les spécifications techniques voir pour les spécifications techniques voir page matériaux, finitions et avertissements).

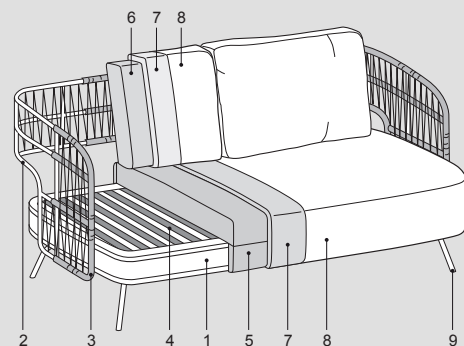
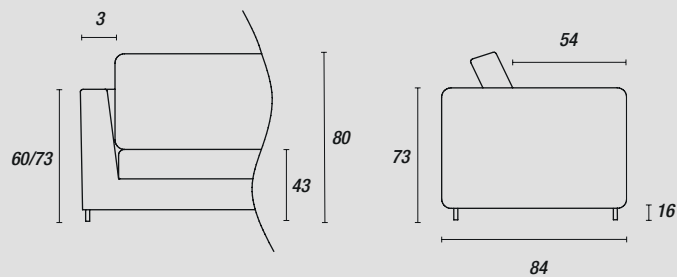



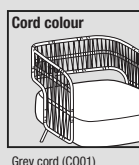
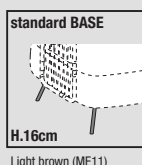

### Base - Piètement::

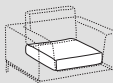
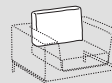

# 356 quilted outdoor

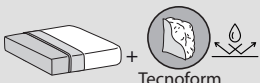

	 Seat - Assise	 Backrest - Dossier	
<b>Upholstering</b> <i>Revetement</i> (8)	Removable <i>Déhoussable</i>	 Fabric	 Fabric
	Not removable <i>Non déhoussable</i>	—	—
<b>Padding</b> <i>Rembourrages</i> (5-6-7)	 D.30kg/m³	 D.18kg/m³	

## TECHNICAL INFORMATION

### Structure: 1-2-3

Structure in plywood panels and solid load-bearing in okume' of various thicknesses.

### Springing: 2-3-4

Tubular backrest in painted metal with outdoor treatment.  
The seat is supported by propylene and latex elastic belts.

### Notes:

Pre-lining in breathable water-repellent material.  
Heat-sealed water-repellent cover available upon request (for technical specifications see Materials, Finishes and Warnings page).

## INFORMATIONS TECHNIQUES

### Structure: 1-2-3

Structure en panneaux de bois lattés multicouches et blocs de support en okume' de différentes épaisseurs.

### Suspension: 2-3-4

Dossier tubulaire en métal peint avec traitement outdoor.  
Assise avec sangles élastiques de fibre propylénique et latex.

### Note:

Pré-doublure en matière respirante et déperlante.  
Disponible sur demande housse hydrofuge thermosoudée (pour les spécifications techniques voir pour les spécifications techniques voir page matériaux, finitions et avertissements).

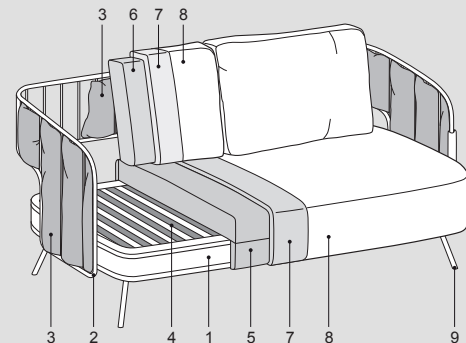
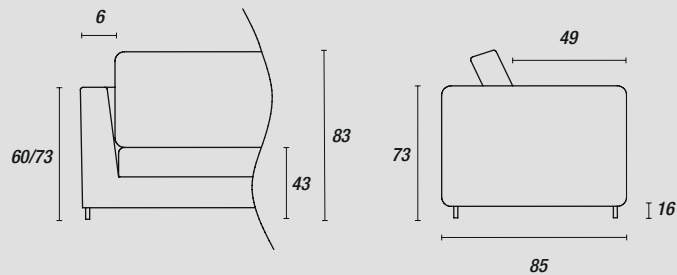

Base - Piètement::

