

Dock low version

SOFAS

2019

Piero Lissoni



Description

In the version with an Eastern-style low seat height, Dock is a collection of upholstered elements with a multiple soul, rendered highly flexible by the countless configurations made possible by the numerous elements included in the collection. This horizontally-spanning project is underscored by a highly textured platform: a dynamic element that extends beyond the sides of the sofa to create a support surface. The slender armrests, available in two depths, are generously padded, just like the backrest. The cushions create a play of sizes and proportions, making it possible to put together double-sided, corner and chaise longue compositions, with or without backrests, suitable for use at the centre of the room or for more traditional solutions. Dock comes with a series of accessories offering a vast array of possibilities: it is possible to insert extra elements between the seat cushions, such as comfortable padded armrests, while functional and supporting elements can be placed on the platform, ensuring further customisation possibilities so as to experience and design the system at will. The body is upholstered in either fabric or leather. Dock also comes in a higher version raised off the ground.

Technical information

Seat internal frame (covered base)

tubular steel and steel profiles, multi-layered wood panel, polyester fibre cover

Seat internal frame (wooden base)

tubular steel and steel profiles, veneered multi-layered wood panel, solid wood

Back and armrest internal frame

tubular steel and steel profiles

Seat cushion upholstery

shaped polyurethane of different density, sterilized down, polyester fibre cover

Back cushion upholstery

sterilized down, polyester fibre cover

Top

veneered MDF wood fibre panel

Cap

steel

Feet

thermoplastic material

Armrest support (DA31B)

aluminium and steel

Armrest top (DA31B)

solid wood, shaped polyurethane of different density, polyester fibre cover

Service element support

steel

Service element top

solid wood or glass

Ferrules

plastic material

Cover

fabric (cannetè profile) or leather

Technical drawings

DB198

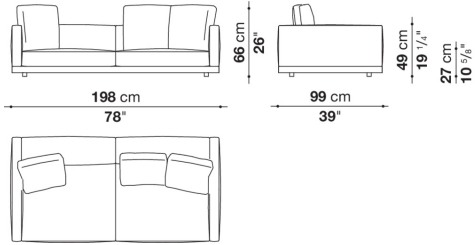

DB239S_1

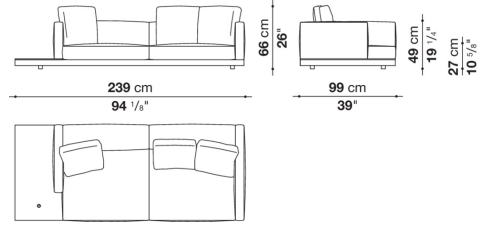

DB239D_1

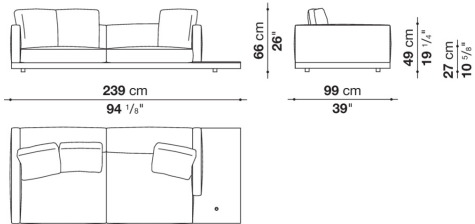

DB239S_2

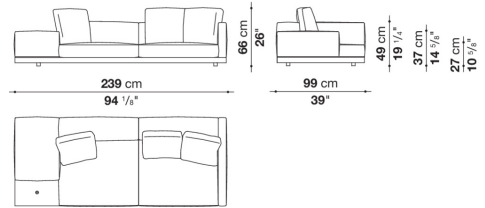

DB239D_2

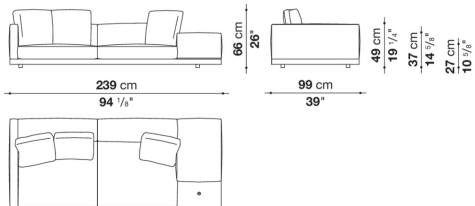

DB280_1

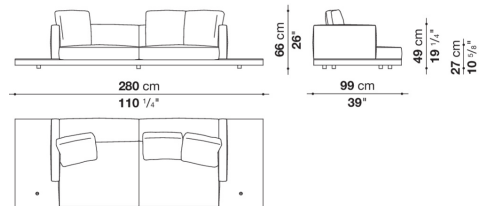

DB280_2

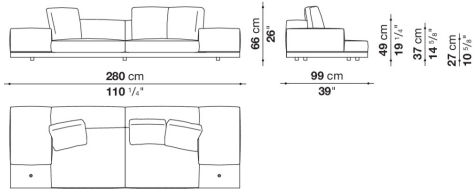

DB280S_3

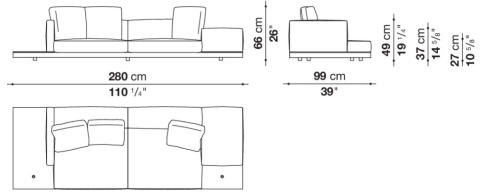

DB280D_3

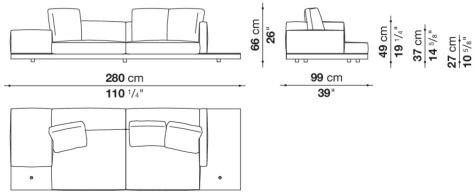

DB288

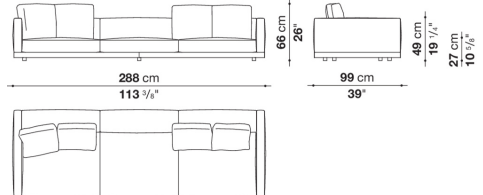

DB329S_1

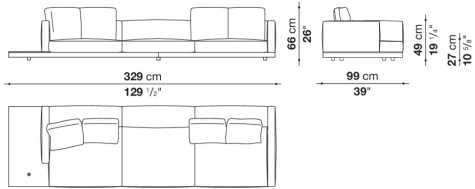

DB329D_1

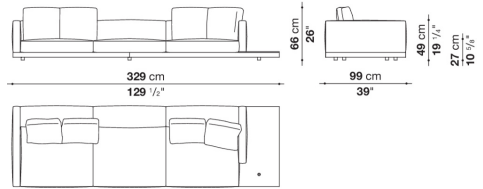

DB329S_2

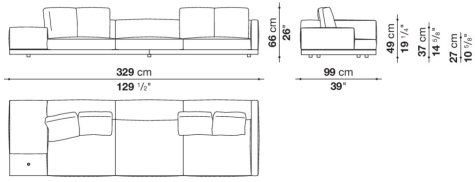

DB329D_2

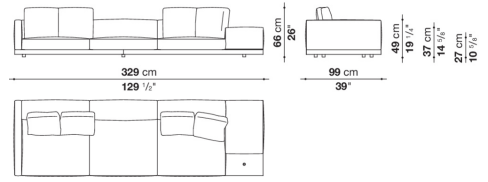

DB370_1

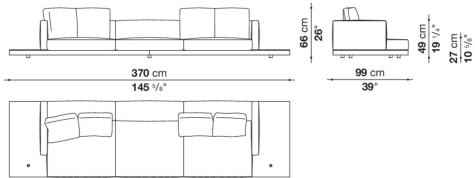

DB370_2

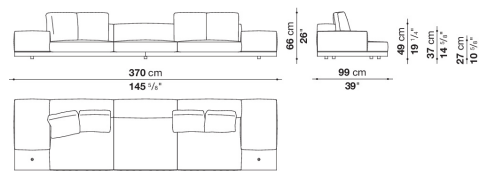

DB370S_3

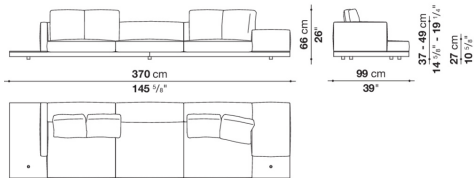

DB370D_3

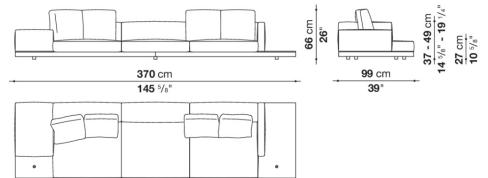

DB189TS

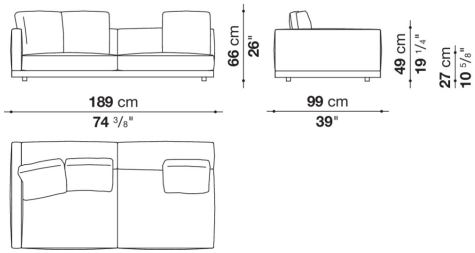

DB189TD

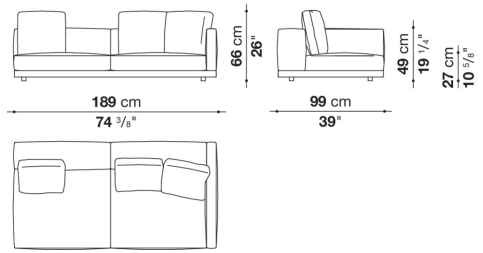

DB230TS_1

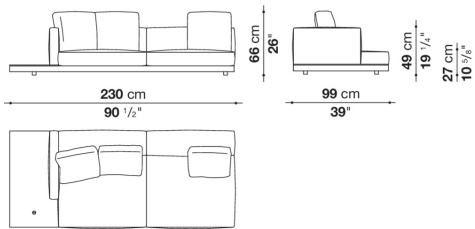

DB230TD_1

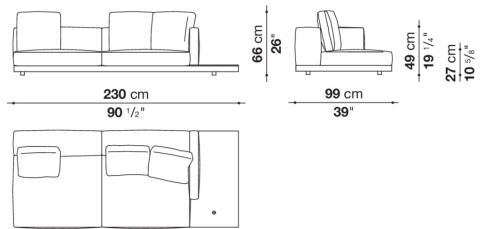

DB230TS_3

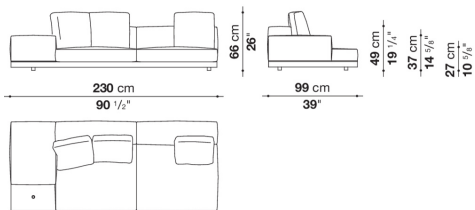

DB230TD_3

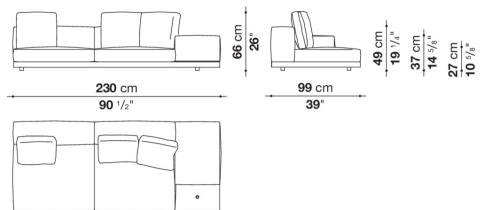

DB320TS_1

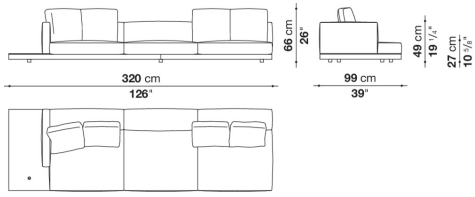

DB320TD_1

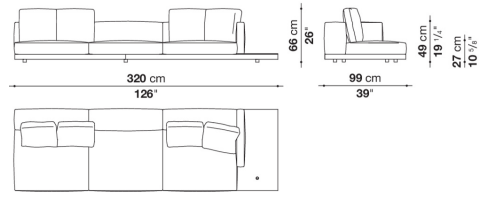

DB320TS_3

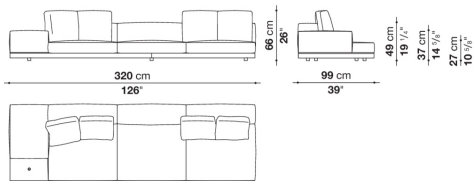

DB320TD_3

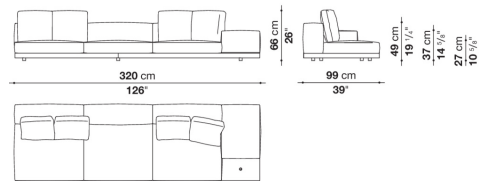

DB279AS_1

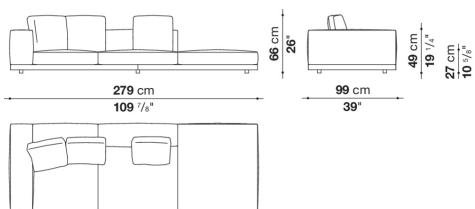

DB279AD_1

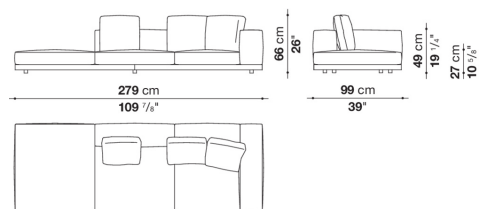

DB288AS

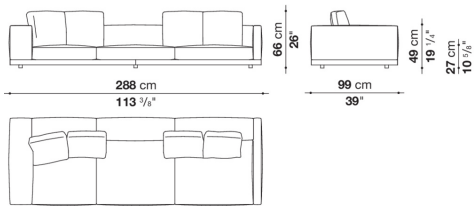

DB288AD

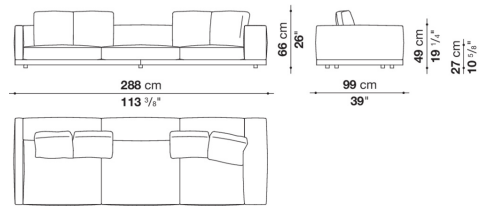

DB288AS_2

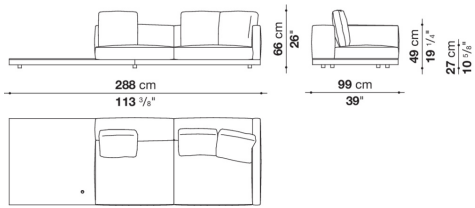

DB288AD_2

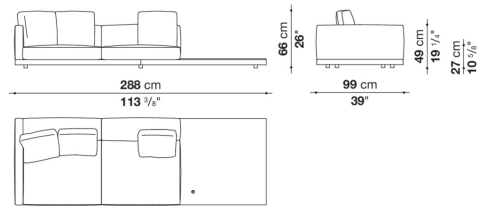

DB329AS_2

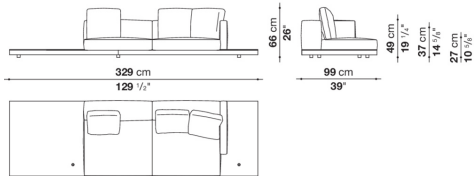

DB329AD_2

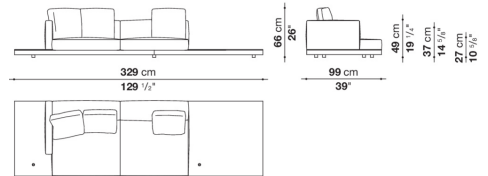

DB329AS_4

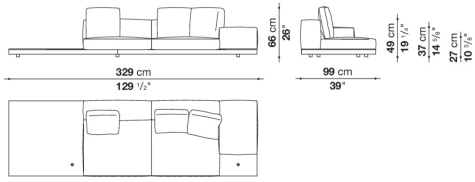

DB329AD_4

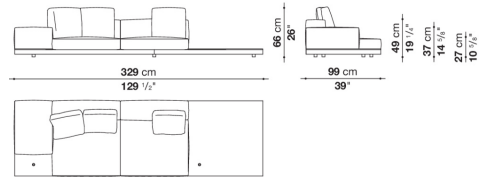

DB150LS_1

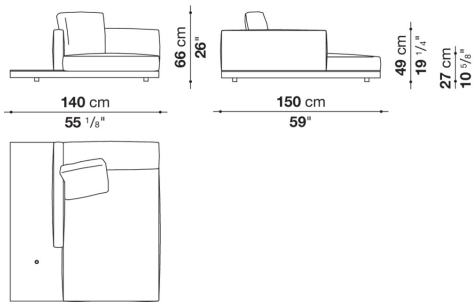

DB150LD_1

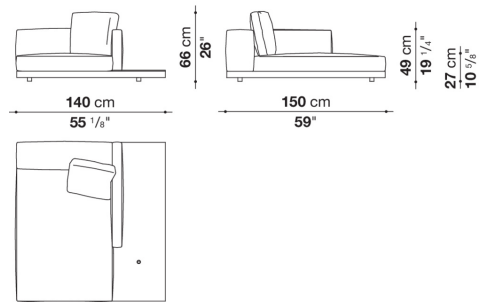

DB150LS_2

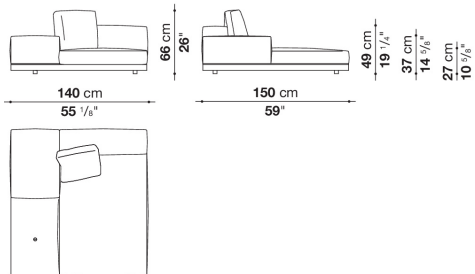

DB150LD_2

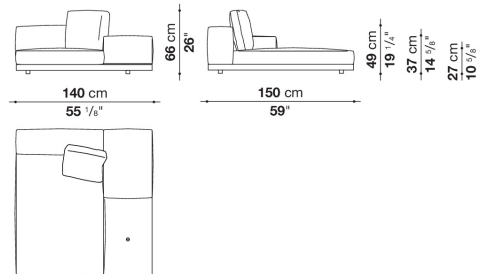

DB280P

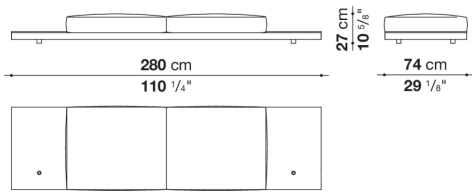

DB320PS_2

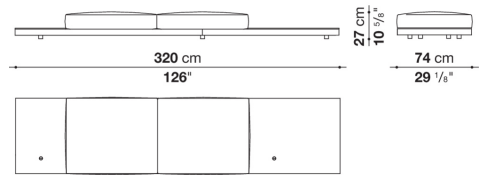

DB320PD_2

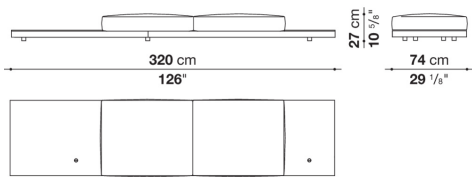

DB370P

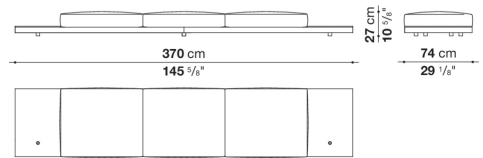

DB370PS

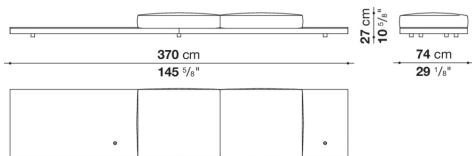

DB370PD

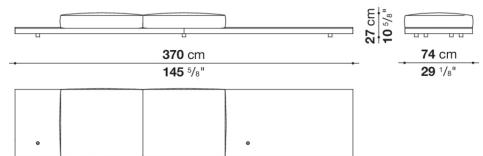

DBL198

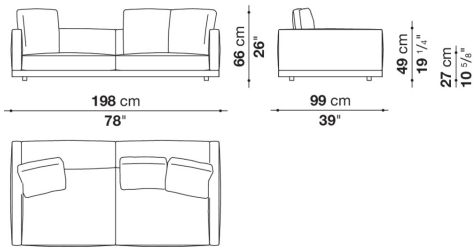

DBL239S_1

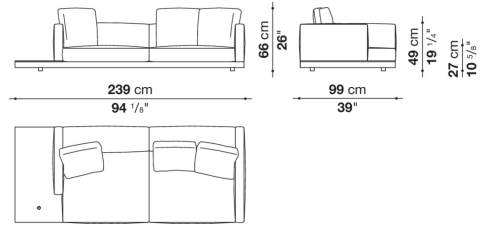

DBL239D_1

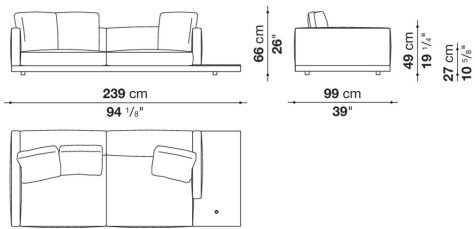

DBL239S_2

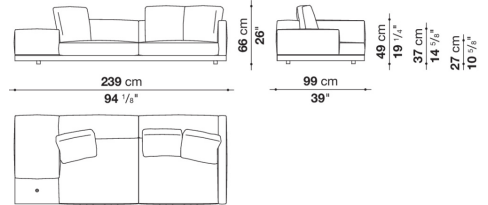

DBL239D_2

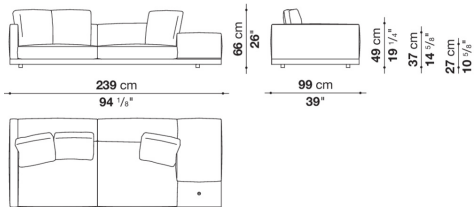

DBL280_1

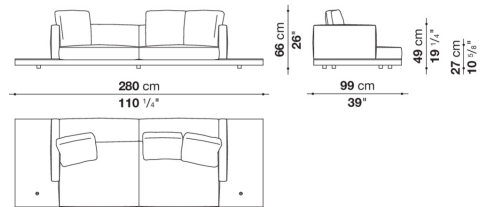

DBL280_2

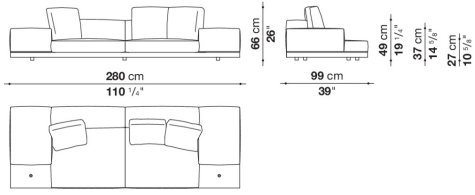

DBL280S_3

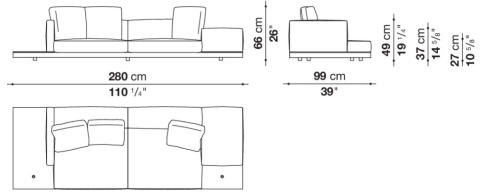

DBL280D_3

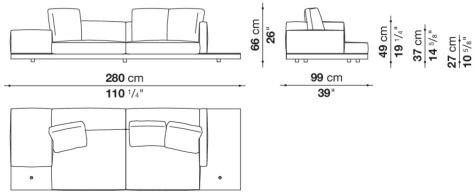

DBL288

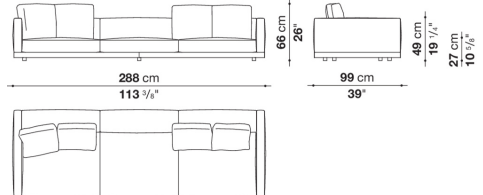

DBL328S_1

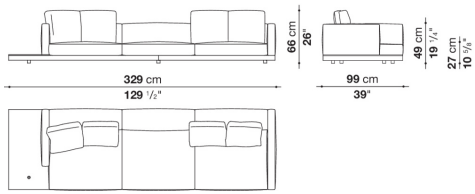

DBL329D_1

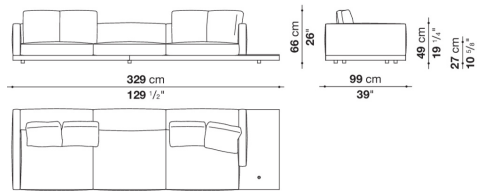

DBL329S_2

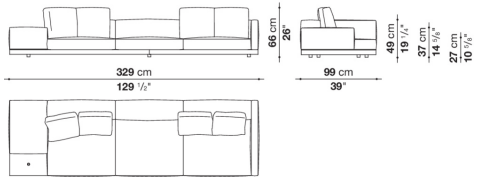

DBL329D_2

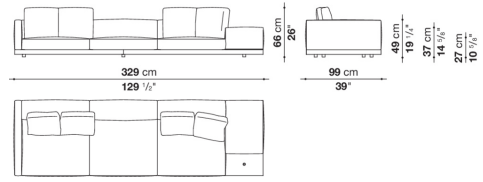

DBL370_1

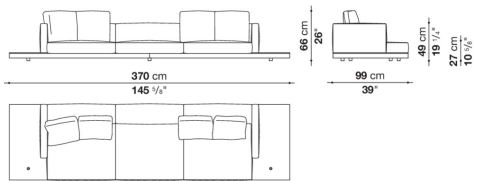

DBL370_2

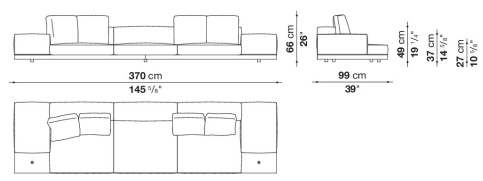

DBL370S_3

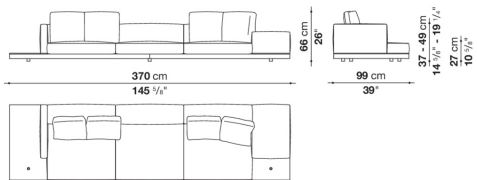

DBL370D_3

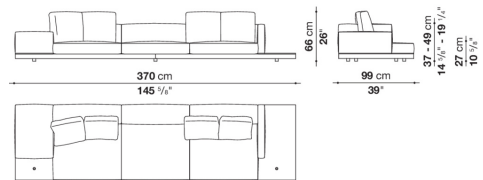

DBL189TS

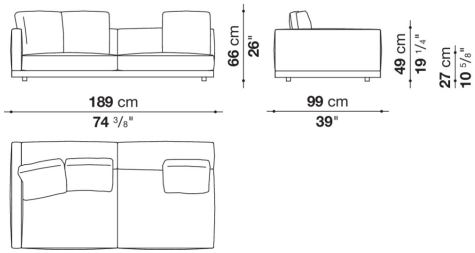

DBL189TD

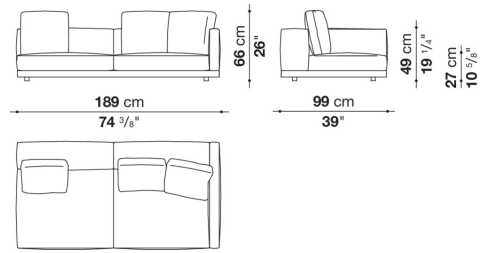

DBL230TS_1

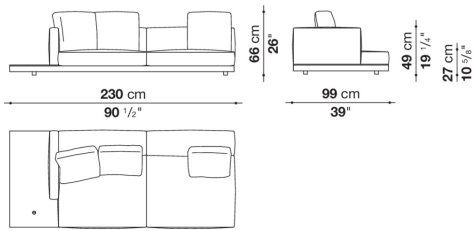

DBL230TD_1

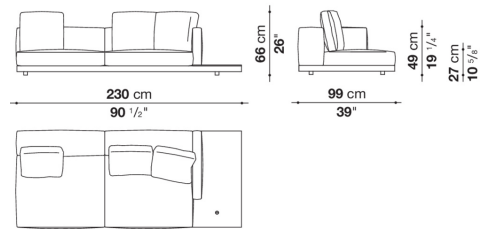

DBL230TS_3

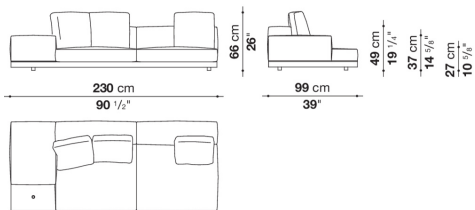

DBL230TD_3

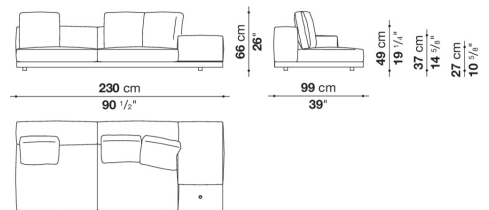

DBL320TS_1

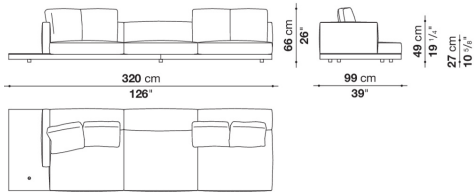

DBL320TD_1

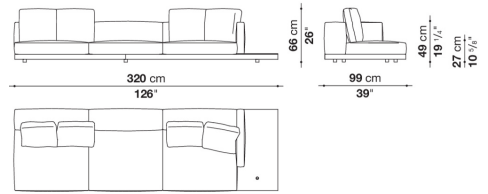

DBL320TS_3

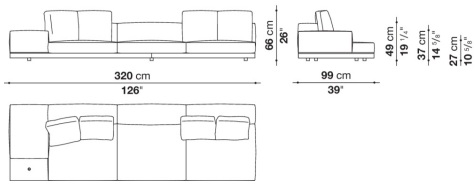

DBL320TD_3

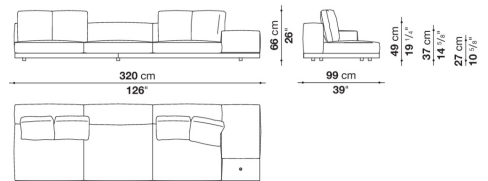

DBL279AS_1

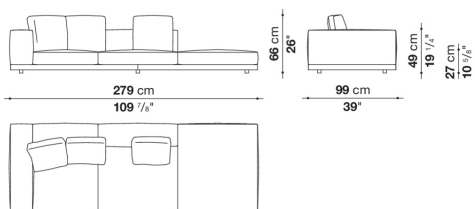

DBL279AD_1

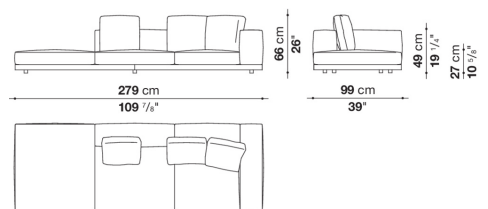

DBL288AS

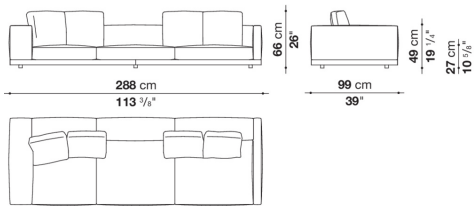

DBL288AD

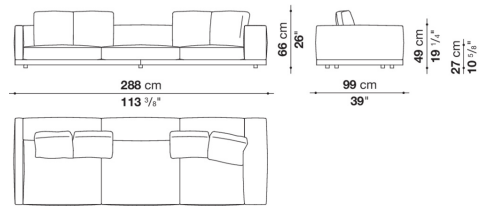

DBL288AS_2

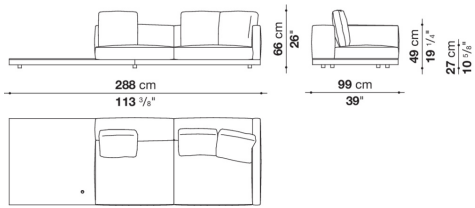

DBL288AD_2

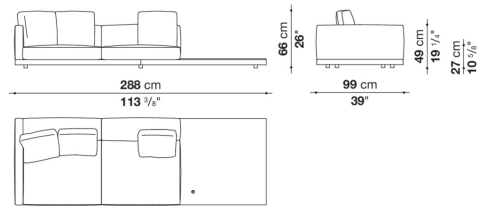

DBL329AS_2

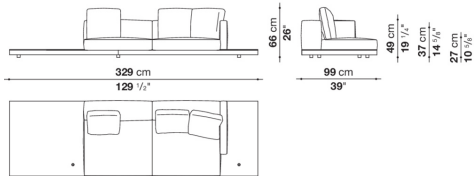

DBL329AD_2

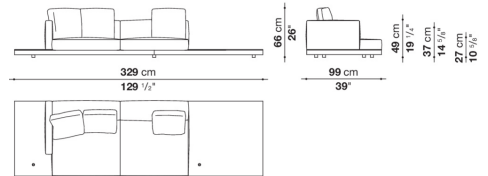

DBL329AS_4

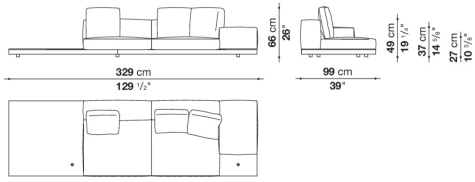

DBL329AD_4

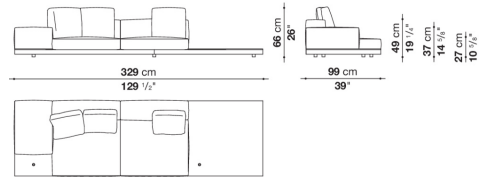

DBL150LS_1

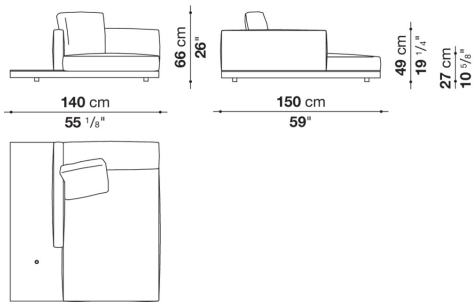

DBL150LD_1

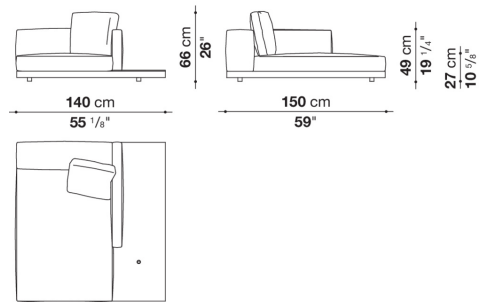

DBL150LS_2

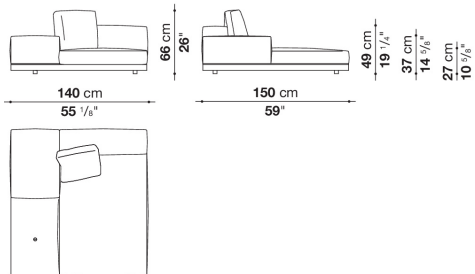

DBL150LD_2

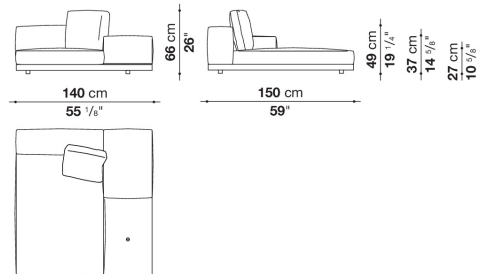

DBL280P

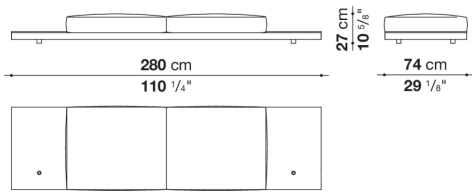

DBL370P

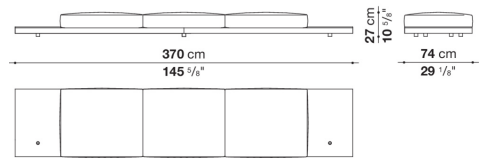

DBL370PS

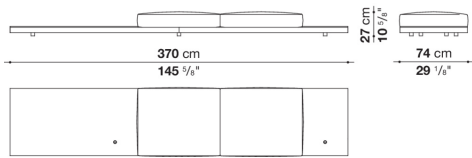

DBL370PD

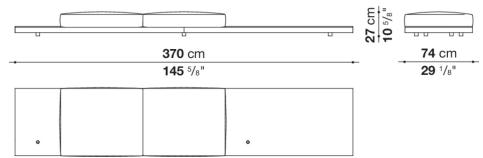

DBL320PS_2

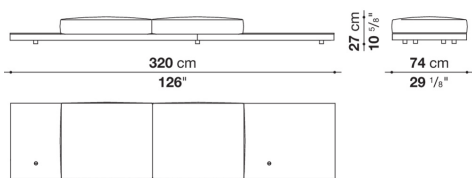

DBL320PD_2

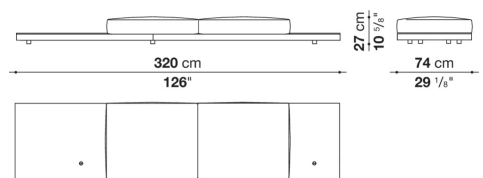

TD23R

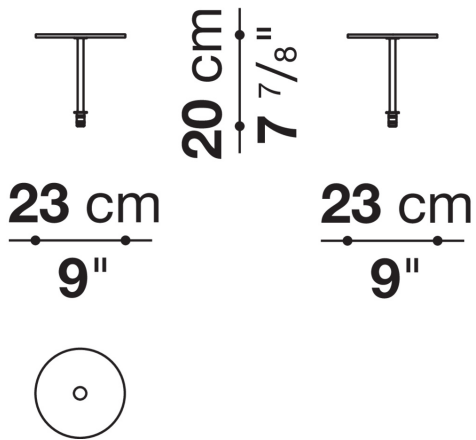

TD23RL

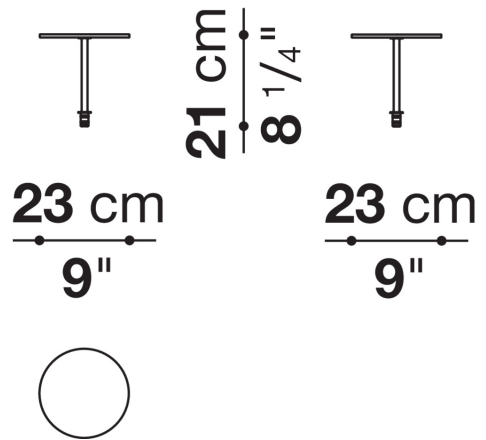

TD36

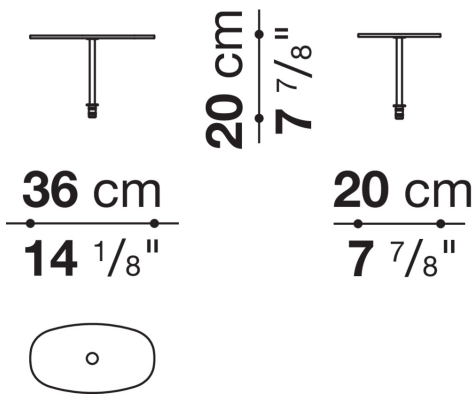

TD36L

