

Siamo solo noi

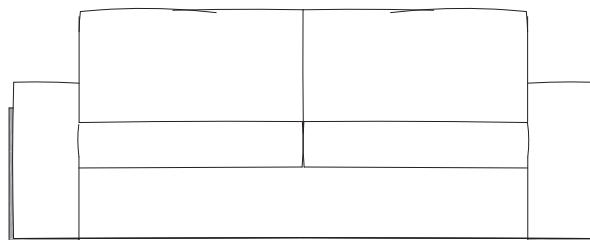





divano letto/sofabed

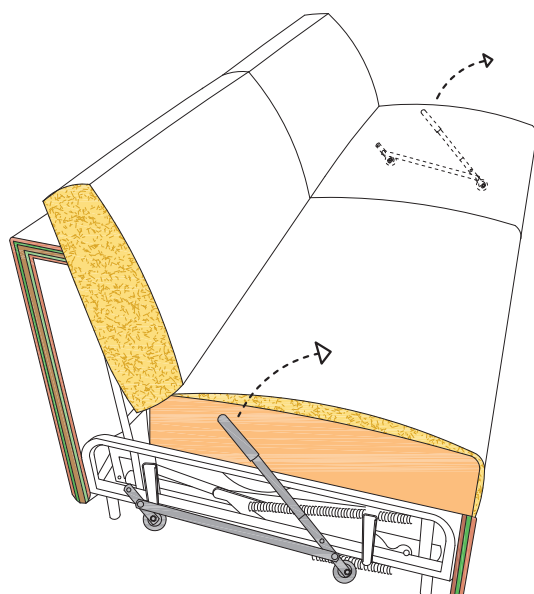

- Struttura:** struttura in legno massello e multistrato, ricoperta con poliuretano espanso indeformabile T 30/N, 40 PH, rivestita con fibra poliestere 100 gr/m² + vellutino. Sostegno bracciolo laterale/piede con finitura cromo lucido. La rete del letto ha doghe in legno; la parte terminale ha cinghie elastiche incrociate che consentono un adeguato comfort alla seduta.
- Structure:** wooden frame covered with polyurethane foam 40/PH, 30/N, covered with polyester fibre 100 gr/m² + velveteen. Support side arm/feet in bright chrome finish. Network bed with wooden slats; the ending part with springing system with crossed elastic webbing in order to provide a comfortable sitting.
- Sedile:** in poliuretano espanso indeformabile PF 40/ M, ricoperto in piuma d'oca vergine ½ B con fodera 100% cotone spigato bianco.
- Seat:** made of non-deformable polyurethane foam PF 40/M, covered with 100% cotton-fabric filled with natural goose feather ½ B.
- Cuscino schienale:** in piuma d'oca vergine con fodera 100% cotone spigato bianco.
Back cushion: in 100% cotton-fabric filled with natural goose feather .
- Materasso:** in poliuretano espanso indeformabile PF 35/ M, ricoperto con cotone/fibra poliestere.
Mattress: made of non-deformable polyurethane foam PF 35/M covered with cotton/polyester fibre
- Rivestimenti:** il modello è realizzabile in tessuto o pelle.
Covers: covers can be made with fabric or leather.

POLIURETANO ESPANSO SENZA C.F.C.
POLYURETHANE FOAM C.F.C. FREE



-  Piuma d'oca vergine
Natural goose feather
-  Poliuretano PF 40/M (3,3 kPa)
Polyurethane PF 40/M (3,3 kPa)
-  F.P. 100 gr/ m² + vellutino.
P.F. 100 gr/ m² + velveteen.
-  Poliuretano 40/PH (8,0 kPa)
Polyurethane 40/PH (8,0 kPa)
-  Poliuretano 40/ TL (6,6 kPa)
Polyurethane 40/TL (6,6 kPa)
-  Poliuretano 30/N (4,5 kPa)
Polyurethane 30/N (4,5 kPa)
-  Struttura in legno massello e multistrato
Frame in solid and multilayer wood

Meccanismo con rotelle su ambo i lati per facilitare il movimento del divano letto
System with wheels on both sides to ease the movement of the sofa bed