

BAI T MA MA OUT

Designed by Neri&Hu



PARACHILNA

hello@parachilna.eu
www.parachilna.eu
+34 93 630 7772

BAI T MA MA OUT

Neri&Hu, 2014

Outdoor suspension lamp. Steel structure in weatherproof dark brown. Diffuser in blown transparent, amber and grey glass. Strip LED column provide ambient light and LED module placed at the bottom provide direct light. Dimmable 1-10v driver included.



Technical Information

Physical	Type	Suspension lamp
	Environment	Outdoor
	Material	Steel structure Blown glass diffuser
	Finish	● Dark brown
	Weight	Net 6.5 kg Gross 9.1 kg
	Cable length	250cm
Electrical	Voltage	230V
	Supply	Terminal strip
	Light source	Strip LED 9.6W 2700K 720Lm - Included Module LED 9W 2700K 1960Lm - Included
	Dimming	1-10 driver - Included

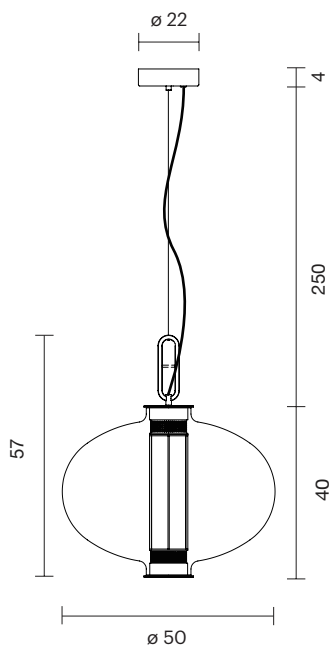
Blueprint



Certifications

CE   IP-65

Codes

Amber diffuser	507000640976
Grey diffuser	507000640977
Transparent diffuser	507000640978

Live photo



Collection



BAI T DI DI
Suspension lamp

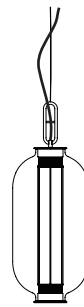

BAI T BA BA
BAI T BA BA OUT
Suspension Lamp

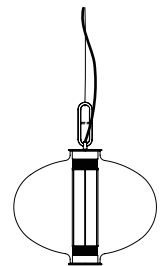

BAI T MA MA
Suspension Lamp

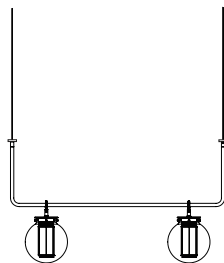

BAI CHANDELIER II
Suspension lamp

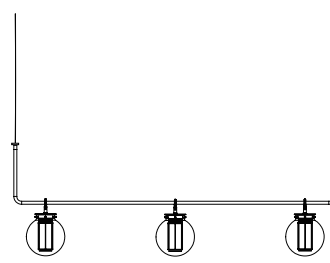

BAI CHANDELIER III
Suspension Lamp

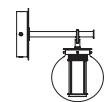

BAI A DI DI
Wall Lamp

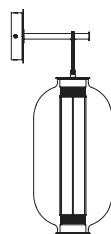

BAI A BA BA
BAI T BA BA OUT
Wall Lamp